



EGS PILLAY



Engineering College

Autonomous

Old Nagore Road, Nagapattinam-611 002, Tamilnadu

Affiliated to Anna University | Approved by AICTE | Accredited by - NBA & NAAC 'A' Grade | Recognised by UGC 2(f) & 12(B) | An ISO 9001:2015 Certified Institution

Counselling Code : 3806

+91-4365-251112/14 | principal@egspec.org/enquires@egspec.org

Department of Electronics and Communication Engineering

(Accredited by NBA)

Design principles for cyber risk impact assessment from Internet of Things (IoT)

Date: 03/03/2022

Time: 3.00 PM – 4.30PM

Theme: "IP Telephony"

by

Dr.R.Saranya, M.E, Ph.d,
Assistant Professor,
Department of CSE,
Central University of tamilnadu,
Thiruvarur.

Convenor : Co-ordinators

(DR.N.PRATHAP) AP/ECE
(MS.K.K.SHANDHOSH SHREE) AP/ECE

(DR. B. PADMANABAN),
HOD/ECE



E.G.S. PILLAY ENGINEERING COLLEGE
(An Autonomous Institution, Affiliated to Anna University, Chennai)
Nagore Post, Nagapattinam – 611 002, Tamilnadu.
Department of Electronics and Communication Engineering

Design principles for cyber risk impact assessment from Internet of Things (IoT)

REPORT

Online Guest Lecture Programme in “**Design principles for cyber risk impact assessment from Internet of Things (IoT)**”, has been conducted in our E.G.S Pillay Engineering College, Nagapattinam, organized by Department of Electronics and Communication Engineering, E.G.S. Pillay Engineering College, Nagapattinam. The Programme was started on 03.03.2022 at 3 pm in online mode.

The one of the co-ordinator **Dr.N.Prathap AP/ECE**, started this course with his welcome address. Head of the department **Dr.B.Padmanaban** gave the keynote address. Our esteemed Principal **Dr.S.Ramabalan** presented the inaugural address and finally Our chief Guest **Dr.R.Saranya, M.E, Ph.d, Assistant Professor, Department of CSE, Central University of tamilnadu**, has explicated about Success full Interview skills needed for Jobs in Electronics and communication sectors, job Market expectations.

Finally, Programme came to a close, with the summary of the whole programme was given by **Dr.N.Prathap AP/ECE**, Coordinator, and Co-Coordinator **Ms.K.K.Shandhosh shree AP/ECE**, proposed vote of thanks.

Coordinators
(Dr.N.Prathap)
(Ms.K.K.Shandhosh shree)

HoD

(Dr. B. Padmanaban)
Dr. B. PADMANABAN, M.E., Ph.D.,
HEAD OF THE DEPARTMENT
DEPARTMENT OF ELECTRONICS AND
COMMUNICATION ENGINEERING
E.G.S. PILLAY ENGINEERING COLLEGE,
NAGAPATTINAM - 611 002.

ATTESTED

Dr. S. RAMABALAN, M.E., Ph.D.,
PRINCIPAL
E.G.S. Pillay Engineering College,
Thethi, Nagore - 611 002.
Nagapattinam (Dt) Tamil Nadu.

26.02.2022

From

Dr.N.Prathap, AP,
K.K.Shandhosh Shree, AP,
Department of ECE,
E.G.S. Pillay Engineering College,
Nagapattinam.

To

The Principal,
E.G.S. Pillay Engineering College,
Nagapattinam.



Respected Sir,

Sub: Requisition to conduct online Lecture- Reg.

We planned to conduct five day value added course on “**Design principles for cyber risk impact assessment from Internet of Things (IoT)**” for final ECE students dated on 03.03.2022. So, we request you to give the permission for this.

Thanking you,

Your's Faithfully



(Dr.N.Prathap)

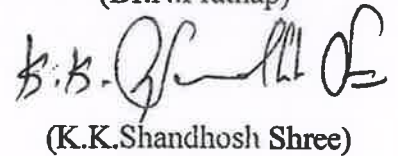

(K.K.Shandhosh Shree)

ATTESTED



Dr. S. RAMABALAN, M.E., PH.D.,
PRINCIPAL
E.G.S. Pillay Engineering College,
Thethi, Nagore - 611 002.
Nagapattinam (Dt) Tamil Nadu.

Date: 26.02.2022

Place: EGSPEC, Nagapattinam

26.02.2022

From

Dr.N.Prathap, AP,
K.K.Shandhosh Shree, AP,
Department of ECE,
E.G.S. Pillay Engineering College,
Nagapattinam.

To

The Principal,
E.G.S. Pillay Engineering College,
Nagapattinam.



Respected Sir,

Sub: Requisition for Budget to conduct online lecture- Reg.

We planned to conduct five day value added course on “**Design principles for cyber risk impact assessment from Internet of Things (IoT)**” for final ECE students dated on 03.03.2022. Approximation budget for this seminar is enclosed with this letter. We request you to kindly do the needful

Thanking you,

Your's Faithfully

(Dr.N.Prathap)

(K.K.Shandhosh Shree)

ATTESTED

Dr.S.RAMABALAN M.E., Ph.D.,
PRINCIPAL
E.G.S. Pillay Engineering College,
Thethi, Nagore - 611 002.
Nagapattinam (Dt) Tamil Nadu.

Date: 26.02.2022

Place: EGSPEC, Nagapattinam



EGS PILLAY



Engineering College

Autonomous

Old Nagore Road, Nagapattinam-611 002, Tamilnadu

Affiliated to Anna University | Approved by AICTE | Accredited by - NBA & NAAC 'A' Grade | Recognised by UGC 2(f) & 12(B) | An ISO 9001:2015 Certified Institution

Counselling Code - 3806

+91-4365-251112/14 | principal@egspeg.org/enquires@egspeg.org

Value added course

On

**Design principles for cyber risk impact assessment from Internet of Things (IoT)
(03.03.2022)**

ORGANIZED BY

Department of Electronics and Communication Engineering

Date: 26.02.2022

BUDGET REQUIREMENT

S.No	Particulars	Amount Required (In Rs.)
01	Resource person honorarium	5,000/-
TOTAL		5,000/-

ATTESTED

Dr. S. RAMABALAN, M.E., Ph.D.,
PRINCIPAL
E.G.S. Pillay Engineering College,
Thethi, Nagore - 611 002,
Nagapattinam (Dt) Tamil Nadu.

Coordinators

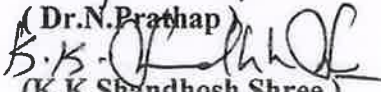
(Dr. N. Prathap)

(K.K. Shandhosh Shree)

HoD

(Dr. B. Padmanaban)

DR. B. PADMANABAN, M.E., Ph.D.
HEAD OF THE DEPARTMENT
DEPARTMENT OF ELECTRONICS AND
COMMUNICATION ENGINEERING
EGS PILLAY ENGINEERING COLLEGE,
NAGAPATTINAM - 611 002.

26.02.2022

From

Dr. B. Padmanaban,
Head of the department,
Department of ECE,
E.G.S. Pillay Engineering College,
Nagapattinam.

To

Dr.R.Saranya, M.E, Ph.d,
Assistant Professor,
Department of CSE,
Central University of tamilnadu,
Thiruvarur.

Respected Madam ,

Sub: Requisition to be an resource person and take session on Internet of Things – Reg.

Respected Sir,

I am very glad to share that, we are going to organize five days value added course on "**Design principles for cyber risk impact assessment from Internet of Things (IoT)**" which is scheduled on 03.03.2022 in online mode.In connection with this, it will be a great pleasure for us to request to be resource person and take session in internet of things .

Thanking you,

Your's faithfully

(Dr. B. Padmanaban)

Place: EGSPEC, Nagapattinam

ATTESTED

Dr. S. RAMABALAN, M.E., Ph.D.,
PRINCIPAL
E.G.S. Pillay Engineering College,
Thethi, Nagore - 611 002.
Nagapattinam (Dt) Tam.

Dr. B. PADMANABAN, M.E., Ph.D
HEAD OF THE DEPARTMENT
DEPARTMENT OF ELECTRONICS AND
COMMUNICATION ENGINEERING
E.G.S. PILLAY ENGINEERING COLLEGE,
NAGAPATTINAM - 611 002.

28.02.2022

From

Dr.R.Saranya, M.E, Ph.d,
Assistant Professor,
Department of CSE,
Central University of tamilnadu,
Thiruvavarur.

To

Dr. B. Padmanaban,
Head of the department,
Department of ECE,
E.G.S. Pillay Engineering College,
Nagapattinam

Respected Sir,

Sub: Acceptance of resource person - **Guest Lecture – Reg.**

Respected Sir,

I am very happy to see your letter about to deliver a value added course on “**Design principles for cyber risk impact assessment from Internet of Things (IoT)**” as a resource person to your students. I would like to take this session . From this letter I confirm my present on 03.03.2022 on your college.

Thanking you,

ATTESTED

Dr. S. RAMABALAN M.E., Ph.D.,
PRINCIPAL
E.G.S. Pillay Engineering College,
Thetpi, Nagore - 611 002.
Nagapattinam (Dt) Tamil Nadu.

Your's Faithfully

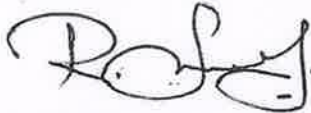

(Dr.R.Saranya, M.E, Ph.d,)

Date: 28.02.2022

Place: Thiruvavarur:



E.G.S. PILLAY ENGINEERING COLLEGE
(An Autonomous Institution, Affiliated to Anna University, Chennai)
Nagore Post, Nagapattinam – 611 002, Tamilnadu.
Department of Electronics and Communication Engineering

ECE/2021/ODD/CIRCULAR-07

DEPARTMENT CIRCULAR DATED

To enhance the practical Skills to face Interview and Some Needed abilities of our ECE students, We are going to conduct the Value added course " Design principles for cyber risk impact assessment from Internet of Things (IoT)" program on 03.03.2022.

OBJECTIVE

An effort to create awareness on cyber risk. To enhance the practical Skills to face Interview and Some Needed abilities.

DAY	Participants	EVENT	RESOURCE PERSON
03.03.2022	IV ECE Students	<ul style="list-style-type: none">• Practical Video of Working Environment.• IC fabrication and Issues• Interview Skills and Knowledges• Some Important Electronics basics	Dr.R.Saranya, M.E, Ph.d, Assistant Professor, Department of CSE, Central University of tamilnadu, Thiruvavur.

ATTESTED

Dr. S. RAMABALAN, M.E., Ph.D.,
PRINCIPAL
E.G.S. Pillay Engineering College,
Thethi, Nagore - 611 002.
Nagapattinam (Dt) Tamil Nadu.









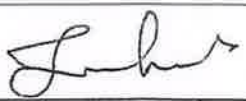

Program Co-ordinators

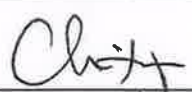
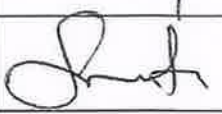
(Dr.N.Prathap)
(Ms.K.K.Shandhosh shree)

HOD/ECE

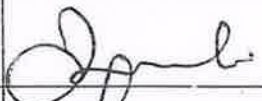
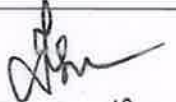
(Dr. B. Padmanaban)

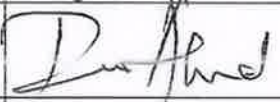
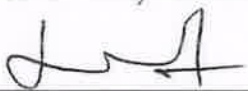
Dr. B. PADMANABAN, M.E., Ph.D.,
HEAD OF THE DEPARTMENT
DEPARTMENT OF ELECTRONICS AND
COMMUNICATION ENGINEERING
E.G.S. PILLAY ENGINEERING COLLEGE,
NAGAPATTINAM - 611 002.

Faculty	Signature	Faculty	Signature
Mr.K.Parthasarathi		Mr.S.JimHawkinson	
Mrs.R.S.Kotteshwari		Mr.S.Senthilkumar	
Mrs.S.Chitra		Mr.T.Senthilkumar	
Mrs.V.Elavarasi		Ms.D.Muthulakshmi	
Mr.D.Devarajan		Ms.S.Dhanalakshmi	
Mr.M.Nuthal Srinivasan		Ms.S.Aadhirai	
Mr.M.Irshad Ahamed			
Mr.L.Ramachandran		--	--

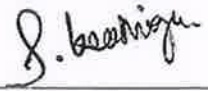
Laboratory Technician	Signature
Mr.K.Raju	
Mr.V.Karthikeyan	
Mrs.S.Keerthiga	
Mr.V.G.Sudharasana Baalajee	
Mr.B.Nirmal Dev	

ATTESTED

Dr. S. RAMABALAN, M.E., Ph.D.,
PRINCIPAL
E.G.S. Pillay Engineering College,
Thethi, Nagore - 611 002.
Nagapattinam (Dt) Tamil Nadu,



EGS PILLAY



Engineering College

Autonomous

Old Nagore Road, Nagapattinam-611 002, Tamilnadu

Affiliated to Anna University | Approved by AICTE | Accredited by - NBA & NAAC 'A' Grade | Recognised by UGC 2(F) & 12(B) | An ISO 9001:2015 Certified Institution

Counselling Code : 380B

+91-4365-251112/14 | principal@egspec.org/enquires@egspec.org

Value added course

on

**Design principles for cyber risk impact assessment from Internet of Things (IoT)
(03.03.2022)**

ORGANIZED BY

Department of Electronics and Communication Engineering

COMMITTEE LIST

Sl. No	Name of the Committee	Committee Representative	Responsibilities
1	Overall Program Coordination	Dr. N. Prathap K.K.Shandhosh shree	Invitation, Brochure, Report Preparation, Programme schedule and Overall Control
2	Comparing	M.Selvasundary S.Jim Hawkinson	Comparing for Inauguration and Valediction, Chief Guest honour.
3	PRO	M.Nuthalsrinivasan, C.Mathuvanesan	Photo Session & Communication

Coordinators
(Dr.N.Prathap)
(Ms.K.K.Shandhosh shree)

HoD
(Dr. B. Padmanaban)

ATTESTED

Dr. S. RAMABALAN, M.E., Ph.D.,
PRINCIPAL
E.G.S. Pillay Engineering College,
Thethi, Nagore - 611 002,
Nagapattinam (Dt) Tamil Nadu.

Dr. B. PADMANABAN, M.E., Ph.D.
HEAD OF THE DEPARTMENT
DEPARTMENT OF ELECTRONICS AND
COMMUNICATION ENGINEERING
E.G.S. PILLAY ENGINEERING COLLEGE,
NAGAPATTINAM - 611 002.



EGS PILLAY



Engineering College

Autonomous

Old Nagore Road, Nagapattinam-611 002, Tamilnadu

Affiliated to Anna University | Approved by AICTE | Accredited by - NBA & NAAC 'A' Grade | Recognised by UGC 2(f) & 12(B) | An ISO 9001:2015 Certified Institution

Counselling Code : 3806

+91-4365-251112/14 | principal@egspec.org/enquires@egspec.org

Value added course

on

Design principles for cyber risk impact assessment from Internet of Things (IoT)

(03.03.2022)

ORGANIZED BY

Department of Electronics and Communication Engineering

PARTICIPATION NAME LIST

Sl.no	REG NUMBER	NAME OF PARTICIPANT	COLLEGE NAME
1	8208E21COF001	ARCHANA.A	E.G.S PILLAY ENGINEERING COLLEGE
2	8208E21COF002	ATSHAYA.N	E.G.S PILLAY ENGINEERING COLLEGE
3	8208E21COF003	BALAYOGESH.E	E.G.S PILLAY ENGINEERING COLLEGE
4	8208E21COF004	DEEPIKA R	E.G.S PILLAY ENGINEERING COLLEGE
5	8208E21COF005	DIVYA.S	E.G.S PILLAY ENGINEERING COLLEGE
6	8208E21COF006	JANANI.K	E.G.S PILLAY ENGINEERING COLLEGE
7	8208E21COF007	KEERTHANA.G	E.G.S PILLAY ENGINEERING COLLEGE
8	8208E21COF008	KEERTHANA.R	E.G.S PILLAY ENGINEERING COLLEGE
9	8208E21COF009	KEERTHIKA.A	E.G.S PILLAY ENGINEERING COLLEGE
10	8208E21COF010	LAKSHMI PRABA.V	E.G.S PILLAY ENGINEERING COLLEGE
11	8208E21COF011	NAJMINA.T	E.G.S PILLAY ENGINEERING COLLEGE
12	8208E21COF012	RAMYA M	E.G.S PILLAY ENGINEERING COLLEGE
13	8208E21COF013	RANJANI.R	E.G.S PILLAY ENGINEERING COLLEGE
14	8208E21COF014	SEETHALADEVI.R	E.G.S PILLAY ENGINEERING COLLEGE
15	8208E21COF015	SHOBICA.P	E.G.S PILLAY ENGINEERING COLLEGE
16	8208E21COF016	SUJITHA.M	E.G.S PILLAY ENGINEERING COLLEGE
17	8208E21COF017	SURIYA.N	E.G.S PILLAY ENGINEERING COLLEGE
18	8208E21COF018	SUSIMA.M	E.G.S PILLAY ENGINEERING COLLEGE

ATTESTED

Dr. S. RAMABALAN, M.E., Ph.D.,
PRINCIPAL
E.G.S. Pillay Engineering College,
Thethi, Nagore - 611 002.
Nagapattinam (Dt) Tamil Nadu.

HoD

(Dr. B. Padmanaban)

Dr. B. PADMANABAN, M.E., Ph.D.,
HEAD OF THE DEPARTMENT
DEPARTMENT OF ELECTRONICS AND
COMMUNICATION ENGINEERING
E.G.S. PILLAY ENGINEERING COLLEGE,
NAGAPATTINAM - 611 002.

Coordinators

(Dr.N.Prathap)

(Ms.K.K.Shandhosh shree)



EGS PILLAY



Engineering College

Autonomous

Old Nagore Road, Nagapattinam-611 002, Tamilnadu

Affiliated to Anna University | Approved by AICTE | Accredited by - NBA & NAAC 'A' Grade | Recognised by UGC 2(f) & 12(B) | An ISO 9001:2015 Certified Institution

Counselling Code - 3806

+91-4365-251112/14 | principal@egspec.org/enquiries@egspec.org

ONE DAY Online Guest lecture

on

Design principles for cyber risk impact assessment from Internet of Things (IoT)

(03.03.2022)

ORGANIZED BY

Department of Electronics and Communication Engineering

Date: 03.03.2022

EXPENDITURE DETAILS

S.NO	PARTICULARS	AMOUNT SPENT (in Rs.)
01	Resource person honorarium	5,000/-
TOTAL		5,000/-

N. Prathap
K.K. Shandhosh shree

Coordinators
(Dr.N.Prathap)
(Ms.K.K.Shandhosh shree)

Dr. B. Padmanaban
HoD
(Dr. B. Padmanaban)

ATTESTED
[Signature]
Dr. S. RAMABALAN, M.E., Ph.D.,
PRINCIPAL
E.G.S. Pillay Engineering College,
Thethi, Nagore - 611 002,
Nagapattinam, (DT) Tamil Nadu.

Dr. B. PADMANABAN, M.E., Ph.D.
HEAD OF THE DEPARTMENT
DEPARTMENT OF ELECTRONICS AND
COMMUNICATION ENGINEERING
E.G.S. PILLAY ENGINEERING COLLEGE,
NAGAPATTINAM - 611 002



EGS PILLAY

Engineering College



Autonomous
Old Nagore Road, Nagapattinam-611 002, Tamilnadu
Affiliated to Anna University | Approved by AICTE | Accredited by - NBA & NAAC 'A' Grade | Recognised by UGC 2(f) & 12(B) | An ISO 9001:2015 Certified Institution
Counselling Code : 3806 | +91-4365-251112/14 | principal@egspec.org/enquires@egspec.org

Value added course
on

Design principles for cyber risk impact assessment from Internet of Things (IoT)
(03.03.2022)

ORGANIZED BY

Department of Electronics and Communication Engineering

Information from participants feedbacks are collectively listed below

1. The topic coverage and relevance of this seminar is very good. (Overall Rating 4)
2. The objective of the seminar is clearly defined. (Overall Rating 4)
3. The quality of delivered contend is very good. (Overall Rating 4)
4. Seminar material is useful. (Overall Rating 3)

Coordinators

(Dr.N.Prathap)
(Ms.K.K.Shandhosh shree)

ATTESTED

Dr. S. RAMABALAN, M.E., Ph.D.,
PRINCIPAL
E.G.S. Pillay Engineering College,
Thetthi, Nagore - 611 002.
Nagapattinam (Dt) Tamil Nadu.

HoD

(Dr. B. Padmanaban)

Dr. B. PADMANABAN, M.E., Ph.D.,
HEAD OF THE DEPARTMENT
DEPARTMENT OF ELECTRONICS AND
COMMUNICATION ENGINEERING
E.G.S. PILLAY ENGINEERING COLLEGE,
NAGAPATTINAM - 611 002.



EGS PILLAY



Engineering College

Autonomous

Old Nagore Road, Nagapattinam-611 002, Tamilnadu

Affiliated to Anna University | Approved by AICTE | Accredited by - NBA & NAAC 'A' Grade | Recognised by UGC 2(f) & 12(B) | An ISO 9001:2015 Certified Institution

Counselling Code : 3806

+91-4365-251112/14 | principal@egspec.org/enquires@egspec.org

Value added course

on

**Design principles for cyber risk impact assessment from Internet of Things (IoT)
(03.03.2022)**

ORGANIZED BY

Department of Electronics and Communication Engineering

MAPPING WITH PO's

PO → Event ↓	PO1	PO2	PO3	PO4	PO5	PO6	PO7	PO8	PO9	P10	PO11	PO12	PSO1	PSC
Design principles for cyber risk impact assessment from Internet of Things (IoT)	S	M	L	L	M			M		M	L	M		S

Program Specific Outcomes (PSO):

After successful completion of the programme, Graduates will be able to

PSO1: Have additional skills and knowledge to design, develop and implement Micro Electronics Applications and Embedded systems.

PSO2: Design systems to solve contemporary issues of modern communication systems, Advanced Networking and High Frequency RF applications.

ATTESTED
[Signature]
Dr. S. RAMABALAN, M.E., Ph.D.
PRINCIPAL

E.G.S. Pillay Engineering College,
Thethi, Nagore - 611 002.
Nagapattinam (Dt) Tamil Nadu.

Attainment Calculations:

S. No	Name	Q1	Q2	Q3	Q4	Q5	Q6	Q7	Q8	Q9	Q10	Total marks
1	ARCHANA.A	2	2	2	2	0	2	2	2	0	2	16
2	ATSHAYA.N	2	2	2	0	2	2	0	2	0	2	14
3	BALAYOGESH.E	0	0	2	2	0	2	2	2	2	2	14
4	DEEPIKA R	2	2	2	2	2	2	2	0	2	0	16
5	DIVYA.S	2	2	2	2	2	0	0	2	2	2	16

6	JANANI.K	2	2	2	2	0	2	2	0	2	2	16
7	KEERTHANA.G	2	2	2	2	2	0	2	2	0	0	14
8	KEERTHANA.R	0	2	0	2	0	2	2	2	2	2	14
9	KEERTHIKA.A	2	2	2	0	0	2	2	2	2	2	16
10	LAKSHMI PRABA.V	0	2	2	2	0	2	2	0	2	2	14
11	NAJMINA.T	2	2	2	2	2	2	0	0	2	2	16
12	RAMYA M	2	0	2	2	2	2	2	0	2	2	16
13	RANJANI.R	2	2	0	0	2	2	0	2	2	2	14
14	SEETHALADEVI.R	2	0	0	0	0	0	2	2	0	2	8
15	SHOBIKA.P	2	2	2	2	0	2	2	2	2	2	18
16	SUJITHA.M	2	2	0	2	2	2	2	2	2	2	18
17	SURIYA.N	2	2	0	2	2	0	2	2	2	0	14
18	SUSIMA.M	2	2	2	2	2	2	2	2	2	0	18
TOTAL Marks		96	98	86	90	82	86	92	82	90	88	272
Attainment percentage		87	89	78	81	74	78	83	74	81	80	75

Attainment Level 1: 60% – 69%

Attainment Level 2: 70% – 79%

Attainment Level 3: >=80%

Achieved attainment level is 3. (81%)

PO Event	PO1	PO2	PO3	PO4	PO5	PO6	PO7	PO8	PO9	P10	PO11	PO12	PSO1	PSO2
Design principles for cyber risk impact assessment from Internet of Things (IoT)	3	2	2	2	2			2		2	1	2		2

N. Prathap
K.K. Shandhosh shree
 Coordinators
 (Dr.N.Prathap)
 (Ms.K.K.Shandhosh shree)

ATTESTED

Dr. S. RAMABALAN, M.E., Ph.D.,
PRINCIPAL
 E.G.S. Pillay Engineering College,
 Thethi, Nagore - 611 002.
 N. apattinam (Dt) Tamil Nadu.

Dr. B. Padmanaban
 HoD
 (Dr. B. Padmanaban)

Dr. B. PADMANABAN, M.E., Ph.D.,
HEAD OF THE DEPARTMENT
DEPARTMENT OF ELECTRONICS AND
COMMUNICATION ENGINEERING
 E.G.S. PILLAY ENGINEERING COLLEGE

Value added course
on
Design principles for cyber risk impact assessment from Internet of Things (IoT)
(03.12.2022)

ORGANIZED BY
Department of Electronics and Communication Engineering

Activity End Report:

1. Expected attainment level (3) of this activity is achieved.
2. Support of this activity to the relevant POs is in the expected level.
3. From the students feedback, this programme can be conducted for upcoming batch students.

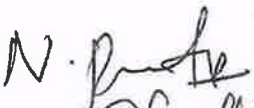
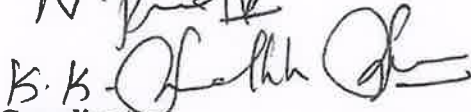

Coordinators
(Dr.N.Prathap)
(Ms.K.K.Shandhosh shree)

HoD
(Dr. B. Padmanaban)

ATTESTED

Dr. S. RAMABALAN, M.E., Ph.D.,
PRINCIPAL
E.G.S. Pillay Engineering College,
Thethi, Nagore - 611 002.
Nagapattinam (Dt) Tamil Nadu.

Dr. B. PADMANABAN, M.E., Ph.D.,
HEAD OF THE DEPARTMENT
DEPARTMENT OF ELECTRONICS AND
COMMUNICATION ENGINEERING
E.G.S. PILLAY ENGINEERING COLLEGE,
NAGAPATTINAM - 611 002.

TEST QUESTIONS

Each Question carry one mark

1

Consider the given circuit in this, the race around

- (A) does not occur
- (B) occur when $CLK = 0$
- (C) occur when $CLK = 1$ and $A = B = 1$
- (D) occur when $CLK = 1$ and $A = B = 0$

The output Y in the circuit below is always '1' when

2

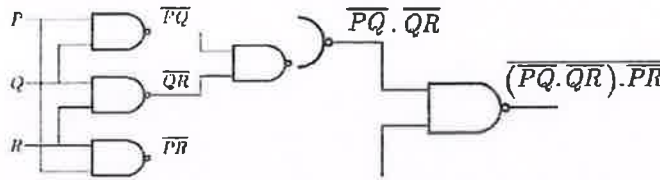

- (A) two or more of the inputs P, Q, R are '0'
- (B) two or more of the inputs P, Q, R are '1'
- (C) any odd number of the inputs P, Q, R is '0'
- (D) any odd number of the inputs P, Q, R is '1'

- 3 In the following figure, C_1 and C_2 are ideal capacitors. C_1 has been charged to 12 V before the ideal switch S is closed at $t = 0$. The current $i(t)$ for all t is

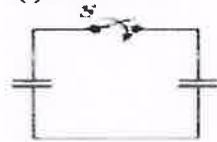

- (A) zero
 - (B) a step function
 - (C) an exponentially decaying function
 - (D) an impulse function
- 4 The average power delivered to an impedance $(4 - j3) \Omega$ $\cos(100\pi t + 100)$ A is
- (A) 44.2 W (B) 50 W (C) 62.5 W (D) 125 W

5

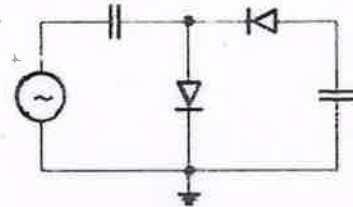

The diodes and capacitors in the circuit shown are ideal. The voltage $v(t)$ across the diode D_1 is

- (A) $\cos(\omega t) - 1$
- (B) $\sin(\omega t)$
- (C) $1 - \cos(\omega t)$
- (D) $1 - \sin(\omega t)$

ATTESTED

[Signature]
Dr. S. RAMABALAN, M.E., Ph.D.
 PRINCIPAL
 E.G.S. Pillay Engineering College
 Thethi, Nagore - 611 002
 Nagapattinam (Dt) Tamil Nadu.

- 6 In the circuit shown, Implement Y, 5 Volts

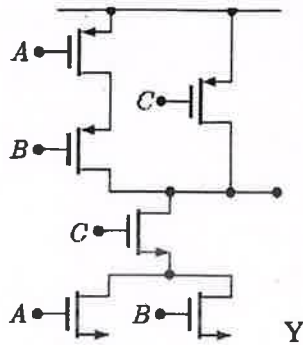

- (A) $Y=AB+C$
 (B) $Y=(A+B)C$
 (C) $Y=(A+B)C$
 (D) $Y=AB+C$

- 7 In the circuit shown below, capacitors C_1 and C_2 are very large and are shorts at the input frequency. v_i is a small signal input. The gain magnitude at 10M rad/sec

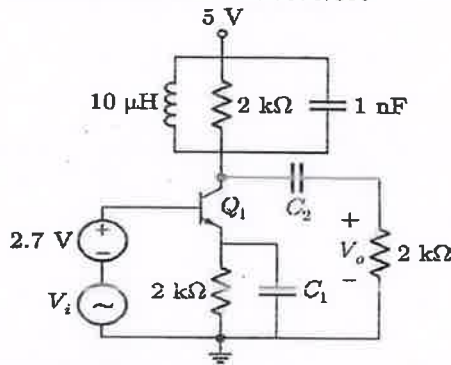

- (A) maximum
 (B) minimum
 (C) unity
 (D) zero

- 8 In the circuit shown below, the current through the inductor is

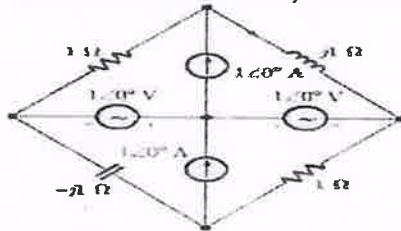

- (A) $(2/1+j)A$
 (B) $-1A$
 (C) $(1/1+j)A$
 (D) $0A$

- 9 The feedback system shown below oscillates at 2rad/s when

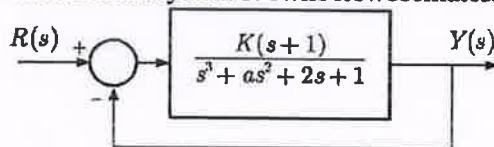

ATTESTED

Dr. S. RAMABALAN, M.E., Ph.D.,
 PRINCIPAL

E.G.S. Pillay Engineering College,
 Thethi, Nagore - 611 002.
 Nagapattinam (Dt) Tamil Nadu.

- (A) $K=2$ and $\alpha=0.75$
- (B) $K=4$ and $\alpha=0.5$
- (C) $K=3$ and $\alpha=0.75$
- (D) $K=2$ and $\alpha=0.5$

10 In the silicon BJT circuit shown below, assume that the emitter area of transistor Q_1 is half that of transistor Q_2

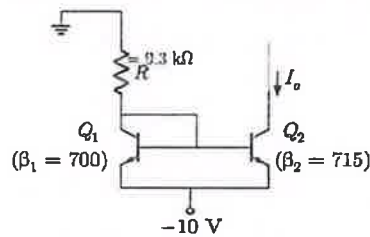

The value of current I_o is approximately

- (A) 0.5mA
- (B) 2ma
- (C) 9.3mA
- (D) 15ma

N. Prathap
B. K. Shandhosh shree
 Coordinators
 (Dr.N.Prathap)
 (Ms.K.K.Shandhosh shree)

gms
 HoD
 (Dr. B. Padmanaban)

Dr. B. PADMANABAN, M.E., Ph.D.,
HEAD OF THE DEPARTMENT
DEPARTMENT OF ELECTRONICS AND
COMMUNICATION ENGINEERING
E.G.S. PILLAY ENGINEERING COLLEGE,
NAGAPATTINAM - 611 302

ATTESTED
[Signature]
Dr. S. RAMABALAN, M.E., Ph.D.
PRINCIPAL
 E.G.S. Pillay Engineering College,
 Thethi, Nagore - 611 002.
 Nagapattinam (Dt) Tamil Nadu

Value added course
on
Design principles for cyber risk impact assessment from Internet of Things (IoT)
(03.03.2022)

ORGANIZED BY
Department of Electronics and Communication Engineering

Recommendation for further actions based on feedback and attainment calculation

1. As we got very good feedback in topic coverage and relevance of this seminar, further more we can arrange more relevant and current trend topics seminar
2. Since Objective of the seminar is clearly defined and quality of delivered content is very good, we will arrange more seminars with same resource person
3. Seminar material is useful but need more clear and in depth concepts we will make more easy materials for understanding and future reference
4. Due to reach of Expected level in program, we will keep arranging similar programs
5. From the students feedback of welcoming, this programme can be conducted for upcoming batch students.

Coordinators
(Dr.N.Prathap)
(Ms.K.K.Shandhosh shree)

ATTESTED

Dr. S. RAMABALAN, M.E., Ph.D.
PRINCIPAL
E.G.S. Pillay Engineering College
Thethi, Nagore - 611 002,
Nagapattinam (Dt) Tamil Nadu.

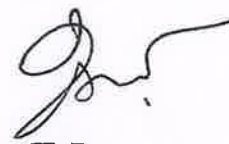
HoD
(Dr. B. Padmanaban)

Dr. B. PADMANABAN, M.E., Ph.D.,
HEAD OF THE DEPARTMENT
DEPARTMENT OF ELECTRONICS AND
COMMUNICATION ENGINEERING
E.G.S. PILLAY ENGINEERING COLLEGE,
NAGAPATTINAM - 611 002.

In call



K.K.Shandhosh Shree ECE (You)



E20ECR006-ADHIR...

Meeting host



AARTHI A



ABDUL RAASHID - ...



AHILLAN RAJ



Aishwarya Ragupat...



B. Prakash



BHUVANESHWARI N



charu charumathi



Dakshana moorthy



K

K.K.Shandriosh Siree ECE (YOU)



Nuthal Srinivasan M

Meeting host



Nuthal Srinivasan M

Meeting host



Nuthal Srinivasan ...

Meeting host



A

Adarsh Chaunal



D

Deepa R ECE



HOD ECE



I

IRSHAD AHAMED....



K

KOTEESWARI.RS ECE



Mahesh N D



MATHUVANESAN.C...



M

Meenu M





K.K.Shandhosh Shree ECE (You)



E20ECR006-ADHIR...

Meeting host



AARTHI A



ABDUL RAASHID - ...



AHILLAN RAJ



Aishwarya Ragupat...



BHUVANESHWARI N



charu charumathi



Dakshana moorthy



Dhanush Vikki



E20ECL320 - kalya...





DEPARTMENT OF ELECTRONICS AND COMMUNICATION
ENGINEERING

CERTIFICATE OF PARTICIPATION

Mr/ Ms ARCHANA A His/Her attended the Value added course on “Design principles for cyber risk impact assessment from internet of things (IOT)” as conducted by the Department Of Electronics And Communication Engineering.

03rd March 2022



COORDINATOR

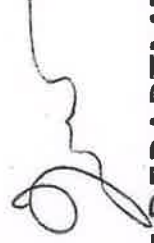

HEAD OF DEPARTMENT(ECE)

ATTESTED

Dr. S. RAMABALAN, M.E., Ph.D.
PRINCIPAL

E.G.S. Pillay Engineering College,
Theethi, Nagore - 611 002.
Nagapattinam (Dt) Tamil Nadu.



DEPARTMENT OF ELECTRONICS AND COMMUNICATION
ENGINEERING

CERTIFICATE OF PARTICIPATION

Mr/ Ms DEEPIKA R His/Her attended the Value added course on “ Design principles for cyber risk impact assessment from internet of things (IOT)” as conducted by the Department Of Electronics And Communication Engineering.

03rd March 2022

B. K. S. Pillay
COORDINATOR

ATTESTED

[Signature]
Dr. S. RAMABALAN, M.E., Ph.D.
PRINCIPAL

E.G.S. Pillay Engineering College,
Thethi, Nagore - 611 002.
Nagapattinam (Dt) Tamil Nadu.

[Signature]
HEAD OF DEPARTMENT(ECE)



DEPARTMENT OF ELECTRONICS AND COMMUNICATION
ENGINEERING

CERTIFICATE OF PARTICIPATION

Mr/ Ms **JANANIK** His/Her attended the Value added course on “ Design principles for cyber risk impact assessment from internet of things (IOT)” as conducted by the Department Of Electronics And Communication Engineering.

03rd March 2022

COORDINATOR

ATTESTED



Dr. S. RAMABALAN, M.E., Ph.D.,
PRINCIPAL

E.G.S. Pillay Engineering College,
Thethi, Nagore - 611.002.
Nagapattinam (Dt) Tamil Nadu.



HEAD OF DEPARTMENT(ECE)



DEPARTMENT OF ELECTRONICS AND COMMUNICATION
ENGINEERING

CERTIFICATE OF PARTICIPATION

Mr/ Ms **NAJMINA T** His/Her attended the Value added course on “Design principles for cyber risk impact assessment from internet of things (IOT)” as conducted by the Department Of Electronics And Communication Engineering.

03rd March 2022

B. S. Pillay
COORDINATOR

ATTESTED
[Signature]
Dr. S. RAMABALAN, M.E., Ph.D.,
PRINCIPAL
E.G.S. Pillay Engineering College,
Thethi, Nagpure - 611 012.
Nagapattinam (DT) Tamil Nadu.

[Signature]
HEAD OF DEPARTMENT(ECE)



DEPARTMENT OF ELECTRONICS AND COMMUNICATION
ENGINEERING

CERTIFICATE OF PARTICIPATION

Mr/ Ms **RANJANI R** His/Her attended the Value added course on “Design principles for cyber risk impact assessment from internet of things (IOT)” as conducted by the Department Of Electronics And Communication Engineering.

03rd March 2022

B. B. J. S. S. S.
COORDINATOR

ATTESTED
[Signature]

Dr. S. RAMABALAN, M.E., Ph.D.,
PRINCIPAL
E.G.S. Pillay Engineering College,
Tiruthi, Nagore - 611 092.
Nagapattinam (Dt) Tamil Nadu.

[Signature]

HEAD OF DEPARTMENT(ECE)



DEPARTMENT OF ELECTRONICS AND COMMUNICATION
ENGINEERING

CERTIFICATE OF PARTICIPATION

Mr/ Ms **BALAYOGESH E** His/Her attended the Value added course on “Design principles for cyber risk impact assessment from internet of things (IOT)” as conducted by the Department Of Electronics And Communication Engineering

03rd March 2022

K. K. Of [Signature]
COORDINATOR

[Signature]

HEAD OF DEPARTMENT(ECE)

ATTESTED

Dr. S. RAMABALAN, M.E., Ph.D.,

PRINCIPAL

E.G.S. Pillay Engineering College,

Therthi, Nagera - 611 002.

Magasathanam (Dt) Tamil Nadu.



DEPARTMENT OF ELECTRONICS AND COMMUNICATION
ENGINEERING

CERTIFICATE OF PARTICIPATION

Mr/ Ms **LAKSHMI PRABA V** His/Her attended the Value added course on “Design principles for cyber risk impact assessment from internet of things (IOT)” as conducted by the Department Of Electronics And Communication Engineering.

03rd March 2022

ATTESTED

Dr. S. RAMABALAN, M.E., Ph.D.
PRINCIPAL

E.G.S. Pillay Engineering College,
Theethi, Nagore - 611 002.
Nagapattinam (Dt) Tamil Nadu.



HEAD OF DEPARTMENT(ECE)



COORDINATOR



E.G.S. PILLAY ENGINEERING COLLEGE(AUTONOMOUS)

Approved by AICTE, New Delhi | Affiliated to Anna University, Chennai
Accredited by NAAC with 'A' Grade | Accredited by NBA(CSE,EEE,MECH,CIVIL,ECE,IT)
An ISO 9001 : 2015 Certified Institution

NAGAPATTINAM – 611002 TAMIL NADU INDIA

Ph : 04365-251112/251114 | E-mail:enquires@egspec.org | Website : www.egspec.org



**DEPARTMENT OF ECE
SPARKS ASSOCIATION
ORGANIZES**

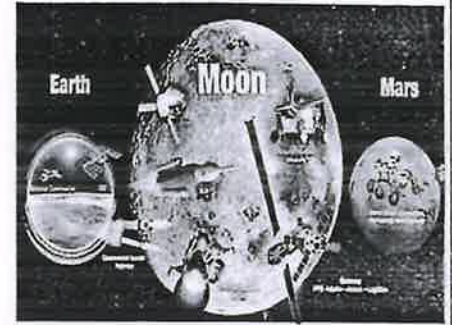

GUEST LECTURE ON

**“SCOPE OF COMMUNICATION ENGINEERING IN SPACE
TECHNOLOGY”**

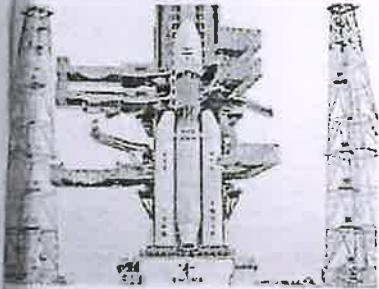

Resource Person

Er.SARAVANAN,

SATCOM RF ENGINEER,

**ISRO Telemetry Tracking & Command Network
Bangalore.**

ON

8TH AUGUST 2021 @ 02.00pm to 03.30pm

CONVENOR

Dr. B. PADMANABAN, HOD/ECE

Program Coordinators

Mrs.V. Elavarasi, AP/ECE & Mr. T. Senthil Kumar, AP/ECE

&

Ms. S. Aathirai, AP/ECE.

Guest Lecture by an ISRO Scientist on 01.08.2021 - 2 p.m to 4 p.m.

Kindly fill out this form for registration of your participation.

senthilkumar.t@egspec.org Switch account



* Required

Email *

Your email

Your Name *

Your answer

Register Number for student / Designation for staff *

Your answer

Department *

ECE

Other:

ATTESTED

**Dr. S. RAMABALAN, M.E., Ph.D.,
PRINCIPAL**

**E.G.S. Pillay Engineering College,
Theni, Nagore - 611 002.
Nagapattinam (Dt) Tamil Nadu.**

Year of studying

- 1st year
- 2nd year
- 3rd year
- Final year

College Name

- E.G.S PILLAY ENGINEERING COLLEGE (AUTONOMOUS), NAGAPATTINAM
- Other:

Contact number *

Your answer

Submit

Clear form

Never submit passwords through Google Forms.

This form was created inside of E.G.S Pillay Engineering College. [Report Abuse](#)

Google Forms

ATTESTED

Dr. S. RAMABALAN, M.E., Ph.D.
PRINCIPAL
E.G.S. Pillay Engineering College,
Thethi, Nagore - 611 002.
Nagapattinam (Dt) Tamil Nadu.



E.G.S. PILLAY ENGINEERING COLLEGE(AUTONOMOUS)

Approved by AICTE, New Delhi | Affiliated to Anna University, Chennai
Accredited by NAAC with 'A' Grade | Accredited by NBA(CSE,EEE,MECH,CIVIL,ECE,IT)
An ISO 9001 : 2015 Certified Institution

NAGAPATTINAM – 611002 TAMIL NADU INDIA

Ph : 04365-251112/251114 | E-mail:enquires@egspec.org | Website : www.egspec.org



DEPARTMENT OF ECE SPARKS ASSOCIATION ORGANIZES

GUEST LECTURE ON "SCOPE OF COMMUNICATION ENGINEERING IN SPACE TECHNOLOGY"

Resource Person
Er.SARAVANAN,
SATCOM RF ENGINEER,
ISRO Telemetry Tracking & Command Network,
Bangalore.

REGISTER
NOW

Registration Link: <https://forms.gle/wvZn7JufNCC9FS2G7>



Google Meet

Google Meet Link: <https://meet.google.com/jtc-xhfv-vdj>

on

31ST JULY 2021 @ 11.00am to 12.30pm

CONVENOR

Dr.B.PADMANABAN, HOD/ECE

Program Coordinators

Mrs.V.Elavarasi, AP/ECE & Mr.T.Senthil Kumar, AP/ECE & Ms.S.Aathirai, AP/ECE.



SENTHIL KUMAR T ECE <senthilkumar.t@egspec.org>

Accepted: Guest Lecture by an ISRO Scientist " Scope Of Communicati... @ Sun
Aug 1, 2021 2pm - 3:30pm (IST) (senthilkumar.t@egspec.org)

message

hirai@egspec.org <aathirai@egspec.org>
Reply-To: aathirai@egspec.org
senthilkumar.t@egspec.org

Sun, Aug 1, 2021 at 8:40 AM

aathirai@egspec.org has accepted this invitation.

Guest Lecture by an ISRO Scientist " Scope Of Communication Engineering in Space Technology"

When Sun Aug 1, 2021 2pm – 3:30pm India Standard Time - Kolkata

Joining info Join with Google Meet
meet.google.com/szv-wfzd-grz

Join by phone
(US) +1 409-344-5816 (PIN: 773850540)

Calendar senthilkumar.t@egspec.org

Who

- senthilkumar.t@egspec.org - organizer
- elavarasi@egspec.org
- hodece@egspec.org
- aathirai@egspec.org
- saraecegeni@gmail.com

Invitation from Google Calendar

You are receiving this email at the account senthilkumar.t@egspec.org because you are subscribed for invitation replies on calendar senthilkumar.t@egspec.org.

To stop receiving these emails, please log in to <https://calendar.google.com/calendar/> and change your notification settings for this calendar.

Forwarding this invitation could allow any recipient to send a response to the organizer and be added to the guest list, or invite others regardless of their own invitation status, or to modify your RSVP. Learn More.

Invite.ics
2K

ATTESTED

Dr. S. RAMABALAN, M.E., Ph.D.,
PRINCIPAL
E.G.S. Pillay Engineering College,
Thethi, Nagore - 611 002.
Nagapattinam (Dt) Tamil Nadu.

12:27 PM

40

820815106008

Assistant Professor

ASSISTANT PROFESSOR

E20ECR098/STUDENT

Asst Professor

E19ECR087

E20ECR035

E20ECR048

E20ECR060

E20ECR011

E20ECR082

E20ECR084

5 more responses are hidden

Department

112 responses

 Copy

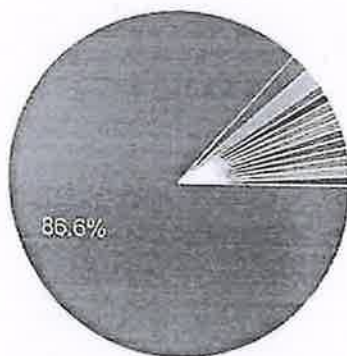

- ECE
- CSE
- EEE
- Mech
- Working as software professi...
- MECHANICAL
- Mechanical
- Bsc

ATTESTED

**Dr. S. RAMABALAN, M.E., Ph.D.,
PRINCIPAL**

**E.O.S. Pillay Engineering College,
Kethi, Nagore - 611 002,
Nagapattinam (Dt) Tamil Nadu.**

Year of studying

 Copy

91 responses

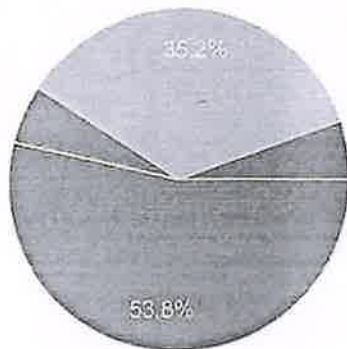

- 1st year
- 2nd year
- 3rd year
- Final year

College Name

 Copy

111 responses

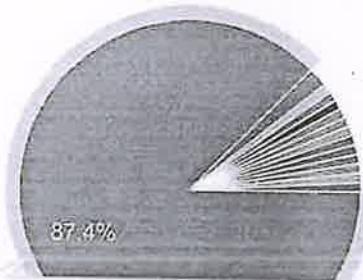

- E.G.S PILLAY ENGINEERIN...
- Easwari Engineering College
- Working professional refered...
- Srv engineering college
- Aarupadai Veedu Institute of...
- SASTRA deemed university
- J.J. College of Engineering a...
- Sri Valliammai Engineering...

E.G.S PILLAY ENGINEERING COLLEGE (AUTONOMOUS), NAGAPATTINAM
97 (87.4%)

ATTESTED



Dr. S. RAMABALAN, M.E., Ph.D.,
PRINCIPAL
E.G.S. Pillay Engineering College,
Thethi, Nagore - 611 002.
Nagapattinam (Dt) Tamil Nadu,

People

Mute all Add people Host controls

In call

- SENTHIL KUMARTE... (You)
- Aadhira ECE
- Abinaya Kumar
- Ajay S
- Ajith Mohan
- AKASH K E19ECL301

37°C Mostly cloudy

2:17 PM

ENG IN 8/1/2021



Sivasuktha S



HOD ECE



You



E20ECR038 - LAKSHMI PRIYAA. P



Aadhira ECE



42 others



ece students



saravanan.god



ELAVARASIV ECE

Type here to search

Dr. S. RAMABALAN, M.E., Ph.D.,
PRINCIPAL
E.G.S. Pillay Engineering College,
Thethi, Nagore - 611 002.
Nagapattinam (Dt) Tamil Nadu.

Account x E.G.S. Pillay Engineering College x Meet - Guest Lecture by an x New Tab x +

meet.google.com/sze-wfzu-giz?authuser=0&nl=0

saravanan god is presenting



Guest Lecture by an ISRO Scientist " Sco...

Type here to search

37°C Mostly cloudy ENG IN 2:26 PM 8/1/2021

saravanan god

ECE E

50 others

You

People

Mute all Add people Host controls

In call

- SENTHIL KUMAR T... (You)
- ECE Anujitha ECE
- Abinaya Kumar
- Ajay S
- Ajith Mohan
- AKASH K E19ECL301

ATTESTED

[Signature]

Dr. S. RAMABALAN, M.E., Ph.D.,
PRINCIPAL
 E.G.S. Pillay Engineering College,
 Thethi, Nadore - 611 002,
 Nagapattinam (Dt) Tamil Nadu.

Account x E.G.S. Pillay Engineering Colleg x Meet - Guest Lecture by an x New Tab x +

meet.google.com/sz...wizn...niz?authuser=0&hl=en

saravanan god is presenting

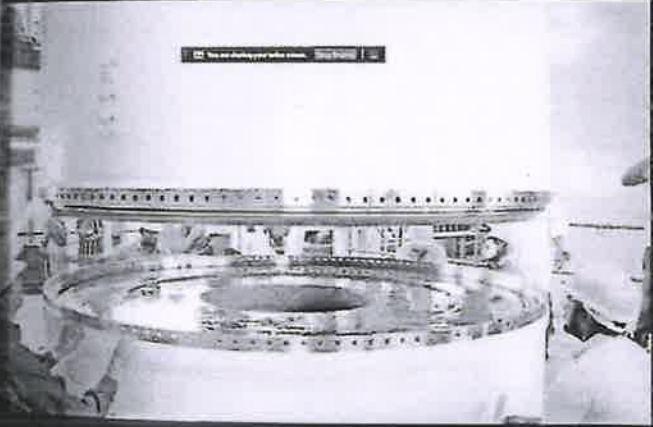

People

Mute all Add people Host controls

In call

- SENTHIL KUMART E... (You)
- ECE Aadhira ECE
- Abinaya Kumar
- Ajay S
- Ajith Mohan
- AKASH K E19ECL301

Guest Lecture by an ISRO Scientist * Sco...

Type here to search

37°C Mostly cloudy 2:26 PM 8/1/2021

ATTESTED
[Signature]
Dr. S. RAMABALAN, M.E., Ph.D.,
PRINCIPAL
E.G.S. Pillay Engineering College,
Thethi, Nagore - 611 002.
Nagapattinam (Dt) Tamil Nadu.

E-Certificate for participation - Guest Lecture by ISRO scientist on 01.08.2021

Dear participants, Kindly fill out this form. Data given in this will be appear in your E-certificate. Also provide your valuable feedback about the session.

* Required

1. Email *

Guest Lecture



E.G.S. PILLAY ENGINEERING COLLEGE(AUTONOMOUS)

Approved by AICTE, New Delhi | Affiliated to Anna University, Chennai
Accredited by NAAC with 'A' Grade (Accredited by NBA/CSE, EEE, MECH, CIVIL, ECE, IT)
An ISO 9001:2015 Certified Institution

NAGAPATTINAM - 611002 TAMIL NADU INDIA

Ph : 04365-251112/251114 | E-mail:enquires@egspec.org | Website : www.egspec.org



**DEPARTMENT OF ECE
SPARKS ASSOCIATION ORGANIZES**

**GUEST LECTURE ON
"SCOPE OF COMMUNICATION ENGINEERING IN SPACE TECHNOLOGY"**

Resource Person
Er.SARAVANAN,
SATCOM RF ENGINEER,
ISRO Telemetry Tracking & Command Network,
Bangalore.

2. Participant Name (in capital letter) *

ATTESTED

**Dr. S. RAMABALAN, M.E., Ph.D.,
PRINCIPAL**

**E.G.S. Pillay Engineering College,
Methu, Nagore - 611 002,
Nagapattinam, Tamil Nadu.**

3. Register Number / Designation for staff members *

4. Department *

Mark only one oval.

ECE

Other: _____

5. College Name *

Mark only one oval.

E.G.S PILLAY ENGINEERING COLLEGE(AUTONOMOUS)

Other: _____

6. Contact number *

Provide your feedback about the session

7. Did you gain knowledge about the topic? *

Mark only one oval.

Yes

No

Maybe

ATTESTED

Dr. S. RAMABALAN, M.E., Ph.D.,
PRINCIPAL

E.G.S. Pillay Engineering College,
Thethi, Nare - 611 002.
Nagapattinam (Dt), Tamil Nadu.

8. Your rating about this overall session *

Mark only one oval.

- Excellent
- Very good
- Good
- Fair
- Poor

9. What aspects of this guest lecture were most useful or valuable? *

10. Any other comments

This content is neither created nor endorsed by Google.

Google Forms

ATTESTED



Dr. S. RAMABALAN, M.E., Ph.D.,
PRINCIPAL

E.G.S. Pillay Engineering College,
Therai, Nagore 611 002.

Nagapattinam (Dt) Tamil Nadu.

E.G.S PILLAY ENGINEERING COLLEGE (AUTONOMOUS)- DEPARTMENT OF ECE-SPARKS ASSOCIATION SPONSORED

GUEST LECTURE ON " SCOPE OF COMMUNICATION ENGINEERING IN SPACE TECHNOLOGY" - 01.08.21

FEEDBACK ANALYSIS REPORT

S.NO	Participant Name (in capital letter)	Register Number / Designation for staff members	Department	College Name	Contact number	Your rating about this overall session	Did you gain knowledge about the topic?	Any other comments	What aspects of this guest lecture were most useful or valuable?
1	S.AADHIRAI	ASSISTANT PROFESSOR	ECE	E.G.S PILLAY ENGINEERING COLLEGE(AUTO NOMOUS)	9787797552	Excellent	Yes		
2	SENTHIL KUMAR T	Assistant Professor	ECE	E.G.S PILLAY ENGINEERING COLLEGE(AUTO NOMOUS)	9486124167	Excellent	Yes		
3	S.AADHIRAI	ASSISTANT PROFESSOR	ECE	E.G.S PILLAY ENGINEERING COLLEGE(AUTO NOMOUS)	9787797552	Excellent	Yes		GAIN KNOWLEDGE
4	AKBAR ALIA	E19ECR012	ECE	E.G.S PILLAY ENGINEERING COLLEGE(AUTO NOMOUS)	9994584786	Excellent	Yes	Good	Very useful
5	Dr.D.Devarajan	Special Professor	ECE	E.G.S PILLAY ENGINEERING COLLEGE(AUTO NOMOUS)	9894055342	Very good	Yes		communication Link aspects of INSAT

Dr. S. RAMABALAN, M.E., Ph.D.,
PRINCIPAL
E.G.S. Pillay Engineering College,
 Thethi, Nagore - 611 002.
 Nagapattinam (Dt) Tamil Nadu.

6	V.ABITHA	E19ECR006	ECE	E.G.S PILLAY ENGINEERING COLLEGE(AUTO NOMOUS)	9597213468	Excellent	Yes	Super	Knowledge
7	M.IRSHAD AHAMEE ASSOCIATE PROFESSOR	E19ECR102	ECE	E.G.S PILLAY ENGINEERING COLLEGE(AUTO NOMOUS)	7904106119	Excellent	Yes	Nothing	Recent activities in ISRO
8	SWETHA.S	E19ECR102	ECE	E.G.S PILLAY ENGINEERING COLLEGE(AUTO NOMOUS)	6385512826	Excellent	Yes	Nothing	Useful
9	NITHIYA BALA .K	E19ECR065	ECE	E.G.S PILLAY ENGINEERING COLLEGE(AUTO NOMOUS)	9788786311	Excellent	Yes	No	Communication topic
10	S.A.TCHAYA	E18ECR010	ECE	E.G.S PILLAY ENGINEERING COLLEGE(AUTO NOMOUS)	8825738779	Excellent	Yes	Very useful session	Very useful session
11	Ramgopal M	E19ECL306	ECE	E.G.S PILLAY ENGINEERING COLLEGE(AUTO NOMOUS)	9344047052	Very good	Yes	Nothing	Yes,
12	V.VINODHINI	E19ECR113	ECE	E.G.S PILLAY ENGINEERING COLLEGE(AUTO NOMOUS)	9790257346	Very good	Yes	No	Yes
13	SOPHIA.V	E19ECR093	ECE	E.G.S PILLAY ENGINEERING COLLEGE(AUTO NOMOUS)	6379757151	Excellent	Yes	No	Valuable
14	M.VEERASANJEEV	E19ECR108	ECE	E.G.S PILLAY ENGINEERING COLLEGE(AUTO NOMOUS)	8668101686	Excellent	Yes	No	Good lecture

Dr. S. RAMIABALAN, M.E., Ph.D.,
PRINCIPAL

E.G.S. Pillay Engineering College,
Therai, Nagore - 611 002.
Nagapattinam (Dt) Tamil Nadu.

Sl. No.	Name	Designation	Department	Institution	Contact No.	Feedback	Response	Remarks
15	SWETHA. S	E19ECR101	ECE	E.G.S PILLAY ENGINEERING COLLEGE(AUTONOMOUS)	6383064254	Excellent	Yes	Useful
16	JAIPOORNA.S	E19ECR036	ECE	E.G.S PILLAY ENGINEERING COLLEGE(AUTONOMOUS)	8489551888	Excellent	Yes	It's really useful for us to about satellite communication knowledge It's is valuable information for us
17	NUTHAL SRINIVAS	Assistant Professor	ECE	E.G.S PILLAY ENGINEERING COLLEGE(AUTONOMOUS)	8667639505	Excellent	Yes	Do more no of programs like this.. Satellite communication
18	ABINAYA KUMAR	E19ECR005	ECE	E.G.S PILLAY ENGINEERING COLLEGE(AUTONOMOUS)	9786182530	Excellent	Yes	Very useful Satelite
19	HASIYATHUL NAFI	E19ECR035	ECE	E.G.S PILLAY ENGINEERING COLLEGE(AUTONOMOUS)	7010579435	Very good	Yes	... Satellite communication
20	K. ABARNA	E20ECR002	ECE	E.G.S PILLAY ENGINEERING COLLEGE(AUTONOMOUS)	7558189494	Excellent	Yes	Very useful session Valuable
21	HARIDHARANI G	E20ECR021	ECE	E.G.S PILLAY ENGINEERING COLLEGE(AUTONOMOUS)	9361470890	Excellent	Yes	Most valuable
22	M.AMIRTHA VARSI	3.12319E+11	EEE	St.josephs college of engineering E.G.S PILLAY ENGINEERING COLLEGE(AUTONOMOUS)	9360564263	Excellent	Yes	Very useful Every aspect
23	SRUTHI.S	E19ECR096	ECE	E.G.S PILLAY ENGINEERING COLLEGE(AUTONOMOUS)	6385910349	Excellent	Yes	Very good session Valuable

Dr. S. RAMA BALAJI
Principal
E.G.S. Pillay Engineering College,
Thethi, Nagore - 611 002,
Nagapattinam (Dt) Tamil Nadu,

24	K.AKASH	E19ECL301	ECE	E.G.S.PILLAY ENGINEERING COLLEGE(AUTO NOMOUS)	9384159956	Very good	Yes	Nope	Very useful
25	KOTEESHWARI ASSOCIATE PROFESSOR		ECE	E.G.S.PILLAY ENGINEERING COLLEGE(AUTO NOMOUS)	9.1849E+11	Excellent	Yes	nice explanation	explanation and visual launching of satellites were very nice
26	S.SUBALAKSHMI	E19ECR098	ECE	E.G.S.PILLAY ENGINEERING COLLEGE(AUTO NOMOUS)	7550263281	Excellent	Yes	Noo	Useful
27	MUKUNTHASRI.R	3.12319E+11	EEE	St.Joseph's college of engineering- chennai	9655586686	Excellent	Yes	informative	gained knowledge
28	MOHAMMED SITHI	E19ECR059	ECE	E.G.S.PILLAY ENGINEERING COLLEGE(AUTO NOMOUS)	7868054316	Excellent	Yes	Good	Communication network
29	S.NAVEEN	E19ECR063	ECE	E.G.S.PILLAY ENGINEERING COLLEGE(AUTO NOMOUS)	9344103763	Excellent	Yes	Very use full for the session thank you sir	Yes
30	AKSAYA.B	E19FCR013	ECE	E.G.S.PILLAY ENGINEERING COLLEGE(AUTO NOMOUS)	9360711048	Excellent	Yes	Thanks for good experience	Valuable
31	K.NIRMALANAND	E19ECR064	ECE	E.G.S.PILLAY ENGINEERING COLLEGE(AUTO NOMOUS)	9150168186	Very good	Maybe	Nothing	Useful
32	J.REXY JENIFER	E19ECR075	ECE	E.G.S.PILLAY ENGINEERING COLLEGE(AUTO NOMOUS)	9360416446	Excellent	Yes		Crystal clear presentation

Dr. S. RAMARAJU
 ENGINEERING
 COLLEGE(AUTO
 NOMOUS)
 PILLAY, Engineering College,
 Thethi, Nagore - 511 002,
 Magapattinam (Dt) Tamil Nadu.

33	R SIVA GANESH	E19ECR091	ECE	E.G.S PILLAY ENGINEERING COLLEGE(AUTO NOMOUS)	9524704176	Excellent	Yes	Nothing	Valuable
34	ASWATHAMAN E	E19ECR018	ECE	E.G.S PILLAY ENGINEERING COLLEGE(AUTO NOMOUS)	9994549267	Very good	Yes	Nice lecture	Scope
35	P. LAKSHMI PRIYA	E20ECR038	ECE	E.G.S PILLAY ENGINEERING COLLEGE(AUTO NOMOUS)	9790073040	Excellent	Yes		This guest is more valuable and also more useful for young talents.
36	SENTHIL KUMAR T	ASSISTANT PROFESSOR	ECE	E.G.S PILLAY ENGINEERING COLLEGE(AUTO NOMOUS)	9486124167	Excellent	Yes	very nice presentation	Most valuable
37	K. VENU PRAKASH	E19ECR109	ECE	E.G.S PILLAY ENGINEERING COLLEGE(AUTO NOMOUS)	6382339879	Very good	Yes		Useful
38	M. vijayalakshmi	E19ECR111	ECE	E.G.S PILLAY ENGINEERING COLLEGE(AUTO NOMOUS)	8523933642	Good	Yes	No	Yes
39	S. Jim Hawkinson	Asst. Professor	ECE	E.G.S PILLAY ENGINEERING COLLEGE(AUTO NOMOUS)	7358591939	Excellent	Yes	Nil	Leo orbits
40	JEGAN.B		ECE	E.G.S PILLAY ENGINEERING COLLEGE(AUTO NOMOUS)	9524952870	Very good	Yes		
41	PRIYANKA. M	E19ECR074		E.G.S PILLAY ENGINEERING COLLEGE(AUTO NOMOUS)	9787525095	Excellent	Yes	Very useful	Yes useful

ATTESTED

DR. S. RAMAKRISHNA
 PRINCIPAL

E.G.S. Pillay Engineering College
 Thothir Nagole - 6
 Nagapattinam (Dt) T.

42	T.ANUSHA	Assistant Professor	Biomedical	E.G.S PILLAY ENGINEERING COLLEGE(AUTO NOMOUS)	7502706292	Excellent	Yes	excellent session	ISRO- Aadithyan mission
43	KEERTHIKA R	ASSISTANT PROFESSOR	ECE	E.G.S PILLAY ENGINEERING COLLEGE(AUTO NOMOUS)	8489485820	Excellent	Yes	very useful session	gained more information about satellite
44	SARAVANAN.S	E19ECR087	ECE	E.G.S PILLAY ENGINEERING COLLEGE(AUTO NOMOUS)	7708843189	Very good	Yes	Nice lecture	Scope
45	N Gopikha	Assistant Professor	Biomedical	E.G.S PILLAY ENGINEERING COLLEGE(AUTO NOMOUS)	7904027113	Excellent	Yes		Presentation was interesting
46	K.Thirulhanjainathar	E17ECR117	ECE	E.G.S PILLAY ENGINEERING COLLEGE(AUTO NOMOUS)	9566331543	Excellent	Yes	Tnq for explain	Very useful
47	KIRTHIKA.K	Assistant professor	BME	E.G.S PILLAY ENGINEERING COLLEGE(AUTO NOMOUS)	8270121991	Very good	Yes	Can conduct more guest lecturer like this in future also	Gave a good Idea about space technology
48	R.ja	E19ECR043	ECE	E.G.S PILLAY ENGINEERING COLLEGE(AUTO NOMOUS)	8220353276	Excellent	Yes	no	yes
49	S.CHITRA	Asst professor	ECS	E.G.S PILLAY ENGINEERING COLLEGE(AUTO NOMOUS)	7598690214	Excellent	Yes	Well organised	Interference with nearby satellite
50	S BHOOPALAN				9500613433	Very good	Yes	Overall good	Space Technology

ATTESTED
 Muthayammal Engineering College
Dr. S. RAMABALAN, Ph.D.,
 Professor
 E.G.S. Pillay Engineering College

Thethi, Nagore - 611 002.
 Nagepattinam (Dt) Tamil Nadu.

51 HEMA V	Assistant Professor	ECE	Muthayammal Engineering College Rasipuram	9500677540	Excellent	Yes	Nil	Useful
				EXCELLENT	38	73.07%		
				VERY GOOD	12	23.07%		
				GOOD	1	1.90%		

Jm

HOD/EE

Dr. B. PADMANABAN, M.E., Ph.D.,
 Professor & Head,
 Department of Electronics and
 Communication Engineering,
 E.G.S. Pillay Engineering College,
 Nagapattinam - 611 002.

ATTESTED

[Signature]

Dr. S. RAMARAJAN, M.E., Ph.D.,
 PRINCIPAL

E.G.S. Pillay Engineering College,
 Thethi, Nagapattinam - 611 002,
 Nagapattinam (Tamil Nadu).



SPARKS ASSOCIATION



Sponsored

GUEST LECTURE
On
"SCOPE OF COMMUNICATION ENGINEERING IN SPACE TECHNOLOGY"
(01.08.2021)

ORGANIZED BY

Department of Electronics and Communication Engineering
E.G.S. PILLAY ENGINEERING COLLEGE, NAGAPATTINAM
(AUTONOMOUS)

(Accredited by NAAC with 'A' grade || Recognized by DSIR || Recognized by UGC 2(f) & 12 (B)|| Provisional Accreditation in NBA for EEE, CSE and Mechanical || Approved by AICTE, New Delhi & Affiliated to Anna University, Chennai)

Information from participants feedbacks are collectively listed below:

Your rating about this overall session:

EXCELLENT	38	73.07%
VERY GOOD	12	23.07%
GOOD	1	1.90%

Coordinators
Mrs.V.Elavarasi
Mr.T.Senthil kumar
Ms.S.Aathirai

HoD
(Dr. B. Padmanaban)

ATTESTED

Dr. S. RAMABALAN, M.E., Ph.D.,
PRINCIPAL
E.G.S. Pillay Engineering College,
Thethi, Nagore - 611 002.
Nagapattinam (Dt) Tamil Nadu.

Dr. B. PADMANABAN, M.E., Ph.D
Professor & Head,
Department of Electronics and
Communication Engineering,
E.G.S Pillay Engineering College,
Nagapattinam - 611 002.



SPARKS ASSOCIATION



Sponsored

GUEST LECTURE
On
"SCOPE OF COMMUNICATION ENGINEERING IN SPACE TECHNOLOGY"
(01.08.2021)

ORGANIZED BY
 Department of Electronics and Communication Engineering
E.G.S. PILLAY ENGINEERING COLLEGE, NAGAPATTINAM
(AUTONOMOUS)

(Accredited by NAAC with 'A' grade || Recognized by DSIR || Recognized by UGC 2(f) & 12 (B)|| Provisional Accreditation in NBA for EEE, CSE and Mechanical || Approved by AICTE, New Delhi & Affiliated to Anna University, Chennai)

MAPPING WITH PO's

PO Event	PO1	PO2	PO3	PO4	PO5	PO6	PO7	PO8	PO9	PO10	PO11	PO12	PSO1	PSO2
GUEST LECTURE On "SCOPE OF COMMUNICATION ENGINEERING IN SPACE TECHNOLOGY"	S	S	-	-	-	S	-	-	-	-	-	M	-	S

[Signature]
Coordinators
 Mrs.V.Elavarasi
 Mr.T.Senthil kumar
 Ms.S.Aathirai

[Signature]
Head
 (Dr. B. Padmanaban)

Dr. B. PADMANABAN, M.E., PH.D.
Professor & Head,
 Department of Electronics and
 Communication Engineering,
 E.G.S. Pillay Engineering College,
 Nagapattinam - 611 002.

ATTESTED
[Signature]
Dr. S. RAMABALAN, M.E., Ph.D.,
PRINCIPAL
 E.G.S. Pillay Engineering College,
 Thethi, Nagore - 611 002.
 Nagapattinam (Dt) Tamil Nadu.



E.G.S. PILLAY
Engineering College

Autonomous

114 Nagore Road, Nagapattinam - 611 002, Tamil Nadu

Department of Electronics and Communication Engineering

CERTIFICATE OF PARTICIPATION

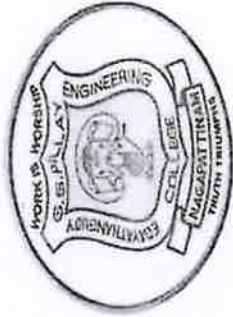

This is to certify that

ABINAYA KUMAR

E19ECR005

from

E.G.S PILLAY ENGINEERING COLLEGE(AUTONOMOUS)

has participated in the SPARKS association organized Guest Lecture by an ISRO Scientist on "Scope of Communication Engineering in Space Technology" on 1st of August 2021.

Handwritten signature of Mrs. V. Elavarasi

Mrs. V. Elavarasi
AP/ECE/Coordinator

Handwritten signature of Mr. T. Senthilkumar

Mr. T. Senthilkumar
AP/ECE/Coordinator

Handwritten signature of Ms. S. Aadhirai

Ms. S. Aadhirai
AP/ECE/Coordinator

Handwritten signature of Dr. B. Padmanaban

Dr. B. Padmanaban,
Prof & Head/ECE/Convener

Handwritten signature of Dr. S. Ramabalan

Dr. S. Ramabalan,
Principal, EGSPEC

ATTESTED

Handwritten signature of Dr. S. Ramabalan

Dr. S. RAMABALAN, M.E., Ph.D.,
PRINCIPAL

E.G.S. Pillay Engineering College,
Thethi, Nagore - 611 002.

Nagapattinam (Dt) Tamil Nadu.

E.G.S.PILLAY ENGINEERING COLLEGE

Nagapattinam-611002.Tamil Nadu,India.

(An Autonomous Institution,Affiliated to Anna University,Chennai.)

DEPARTMENT OF INFORMATION TECHNOLOGY

VALUE ADDED COURSE ON COMPUTER VISION AND IMAGE PROCESSING

CONTENTS

S.NO	CONTENTS	PAGE NO
1	Requestion Letter	1
2	Circular	2
3	Brochure	3
4	Report	4
5	Schedule	5
6	Participants Name List	6
7	Attendance Sheet	8
8	Questions	11
9	Feedback	12
10	Certificate	13
11	Action taken Report	14



EGS Pillay Engineering College (AUTONOMOUS)

Department of ECE

**Three Days Value added Course on
MATLAB and its Applications**

Mode of Session: Direct

Date and Time: 09.12.2021, 10.12.2021 and 11.12.2021 at 9.30AM to 04.30PM (Three Days)

Event Type: MATLAB Value Added Course

Relevant for: II ECE Students, Faculty Members interested in MATLAB Fundamentals, Image Processing, Computer Vision, Machine Learning and Deep Learning.

Suitable Departments: Electronics and Communication Engineering.

Abstract

Date and Time	Topic
10.12.2021 9.30AM to 01.00 PM	<i>Introduction to MATLAB and Simulink Products</i>
10.12.2021 01.00 AM to 02.00PM	<i>Lunch Break</i>
10.12.2021 02.00PM to 04.30PM	<i>Hands-on session (MATLAB and Simulink Onramp)</i>
11.12.2021 9.30AM to 01.00 PM	<i>Overview of all toolbox in MATLAB</i>
11.12.2021 01.00PM to 02.00PM	<i>Lunch Break</i>
11.12.2021 02.00PM to 04.30PM	<i>Hands-on session (All the toolbox Onramp)</i>
12.12.2021 9.30AM to 01.00 PM	<i>Simple Application using MATLAB</i>
12.12.2021 01.00PM to 02.00PM	<i>Lunch Break</i>
12.12.2021 02.00PM to 04.30PM	<i>Hands-on session (Simple Application)</i>

Prerequisites:

- ❖ Prior knowledge of high school mathematics and statistics is expected. No prior exposure to Machine Learning and Deep Neural Networks is required. Understanding of Image processing concepts like image segmentation and image analysis is a plus.

ATTESTED

Dr. S. RAMABALAN, M.E., Ph.D.
PRINCIPAL

E.G.S. Pillay Engineering College,
Thethi, Nagore - 611 002.

Nagapattinam (Dt) Tamil Nadu

- ❖ Creating a MathWorks account through your University email ID is required.

Infrastructure Requirements:-

- ❖ We request a conference room or a computer lab with a projector. Attendees would need to have access to MATLAB R2021b or previous version, either through lab computers, or their own laptops. Reliable internet connectivity for attendees is also necessary.

Required for Onramp Sessions:-

- ❖ Good internet connection with Computer,
- ❖ Earphone (individual for each participants).

Outcome:-

After attending this workshop, attendees should be able to:

- ❖ Understand MATLAB and Simulink fundamentals for Engineering Applications.
- ❖ Understand at a high-level, the terminology used in AI – Machine Learning, and Deep Learning.
- ❖ Learn how to apply deep neural networks for image processing applications.
- ❖ Be aware of all the tools from the Matlab that help in exploring image processing, computer vision, data analysis and statistics problems.

Presenter Name: D. Rajkumar, DesignTech - Chennai

Presenter Bio:



Rajkumar.D

rajkumar.d@designtechsys.com

Mr.D.Rajkumar, working as Application Engineer at **DesignTech Systems Pvt.Ltd**,inChennai,TamilNadu,India.HeholdsaMaster'sDegreeinAppliedElectronicsfromAnna University, CEG Campus (Chennai) and He has the top skills in Data analysis,Machine learning and Deep Learning also he possess strong knowledge on varioustoolslikeMATLAB,ThingSpeak,ImageprocessingandSystemModeling&Simulationetc.,andhe hascompleted3 Governmentfundedprojects.

He had successfully delivered many training workshops and Technical seminars tovarious institutions and companies. Prior to joining DesignTech, His first career was a project Engineer at Raja Ramana Centre for Advanced Technology (RRCAT),followedwith beingtechnicalfacultyCEGCampus Anna University.

ATTESTED

**Dr. S. RAMABALAN, M.E., Ph.D.,
PRINCIPAL**

E.G.S. Pillay Engineering College
Thethi, Nagore - 611 002.
Nagapattinam (Dt) Tamil Nadu.

Permission Letter

Nagapattinam,
30.11.2018

From

Mr. M. Nuthal Srinivasan & Mr. C. Mathuvanesan
Department of ECE ,
E.G.S Pillay Engineering College,
Nagapattinam – 611 002

To

The Secretary,
E.G.S.Pillay Engineering College,
Nagapattinam – 611 002

Thro' Proper channel

Respected Sir,

Subject: Reg –Need Permission - Value added Course on MATLAB - 10.12.2018 to 12.12.2018

As per discussion with the Design Tech Systems Pvt. Ltd., for MATLAB Value added course on 10.12.2018 to 12.12.2018 (Three Days) titled "*MATLAB and its applications*". So, kindly give permission to conduct the Value-added course on the above respective dates.

Thanking You,



ATTESTED

Dr. S. RAMABALAN, M.E., Ph.D.,
PRINCIPAL
E.G.S. Pillay Engineering College,
Thethi, Nagore - 611 002.
Nagapattinam (Dt) Tamil Nadu.

PRINCIPAL
E.G.S. Pillay Engineering College,
Nagapattinam.

Yours Truly

30/11/2018.

30/11/2018

Requisition Letter

Nagapattinam,

1.12.2018

From

Mr. M. Nuthal Srinivasan & Mr. C. Mathuvanesan,
Department of ECE,
E.G.S. Pillay Engineering College,
Nagapattinam – 611 002

To

The Secretary,
E.G.S. Pillay Engineering College,
Nagapattinam – 611 002

Thro' proper channel

Respected Sir,



Subject: Reg – Need of amount for the MATLAB Value added Course.

We need to conduct the 3 days MATLAB Value added course (10.12.2018 to 12.12.2018) with your permission. For the program the following expenses need to pay. So, kindly provide the below mentioned expenses.

Thanking You,

1. Tea & Snacks (3 Days)	-	Rs. 3000
2. Lunch for resource person (3 days)	-	Rs. 500
3. Flux	-	Rs. 350
4. Pen for Participants	-	Rs. 100
5. Binding Paste	-	Rs. 50
6. Miscellaneous	-	Rs. 500
TOTAL	-	RS. 4500

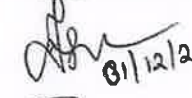
Yours Faithfully

01/12/2018

11/12/2018



1/12/18

Dr. S. RAMABALAN, M.E., Ph.D.,
PRINCIPAL
E.G.S. PILLAY ENGINEERING COLLEGE
NAGAPATTINAM - 611 002.
PRINCIPAL
E.G.S. Pillay Engineering College
Nagapattinam.

E.G.S.PILLAY ENGINEERING COLLEGE
(AUTONOMOUS, Accredited by NBA, NAAC, Affiliated to Anna
University, Approved by AICTE, New Delhi)

CERTIFICATE OF PARTICIPATION

This certificate is awarded to

Mr. M. Nuthal Srinivasan

For her/his active and significant participation
In the Three-day Value-added Course on MATLAB AND ITS APPLICATIONS.
10.12.2018 to 11.12.2018

ATTESTED

Program Organizer 1 Program Organizer 1 HoD/ECE
Dr. S. RAMABALAN, M.E., Ph.D.
PRINCIPAL
E.G.S. Pillay Engineering College,
Thethi, Nagore - 611 002
Nagapattinam (Dt) Tamil Nadu.



E.G.S. PILLAY ENGINEERING COLLEGE

(An Autonomous Institution, Affiliated to Anna University, Chennai)
Nagore Post, Nagapattinam – 611 002, Tamilnadu.

Department of Electronics and Communication Engineering

**Three Days Faculty Development Program on
MATLAB and its Applications**

Sample Photos (10.12.2018 to 12.12.2018)

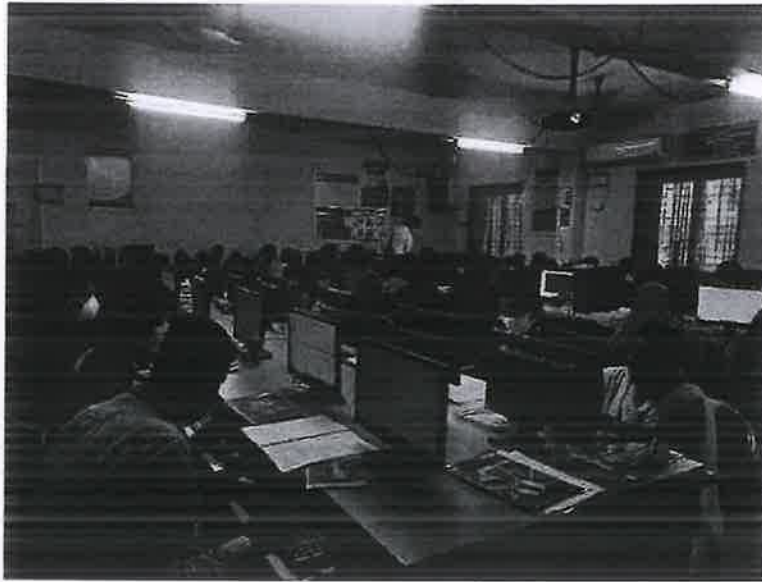

ATTESTED

**Dr. S. RAMABALAN, M.E., Ph.D.,
PRINCIPAL**

**E.G.S. Pillay Engineering College,
Thethi, Nagore - 611 002.
Nagapattinam (Dt) Tamil Nadu.**



E.G.S. PILLAY ENGINEERING COLLEGE

(An Autonomous Institution, Affiliated to Anna University, Chennai)

Nagore Post, Nagapattinam – 611 002, Tamilnadu.

Department of Electronics and Communication Engineering

Three Days Faculty Development Program on

MATLAB and its Applications

Sample Photos (10.12.2018 to 12.12.2018)

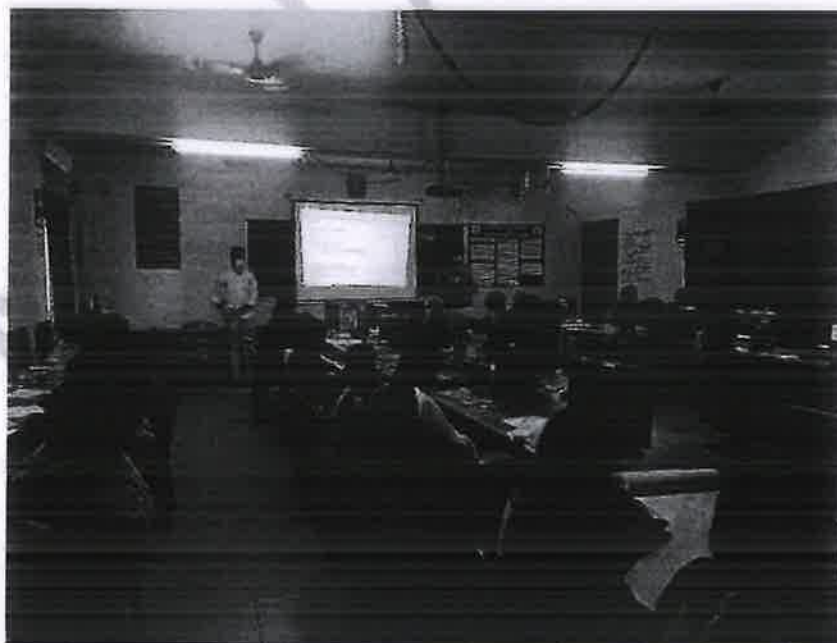

ATTESTED

[Signature]
Dr. S. RAMABALAN M.E., Ph.D.,
PRINCIPAL

E.G.S. Pillay Engineering College,
Thettai, Nagore - 611 002,
Nagapattinam, (Dt) Tamil Nadu.



E.G.S. PILLAY ENGINEERING COLLEGE

(An Autonomous Institution, Affiliated to Anna University, Chennai)

Nagore Post, Nagapattinam – 611 002, Tamilnadu.

Department of Electronics and Communication Engineering

Three Days Faculty Development Program on

MATLAB and its Applications

Sample Photos (10.12.2018 to 12.12.2018)



ATTESTED

**Dr. S. RAMABALAN, M.E., Ph.D.,
PRINCIPAL**

**E.G.S. Pillay Engineering College,
Thethi, Nagore - 611 002.
Nagapattinam (Dt) Tamil Nadu.**



E.G.S. PILLAY ENGINEERING COLLEGE

(An Autonomous Institution, Affiliated to Anna University, Chennai)

Nagore Post, Nagapattinam – 611 002, Tamilnadu.

Department of Electronics and Communication Engineering

Three Days Faculty Development Program on

MATLAB and its Applications

Sample Photos (10.12.2018 to 12.12.2018)

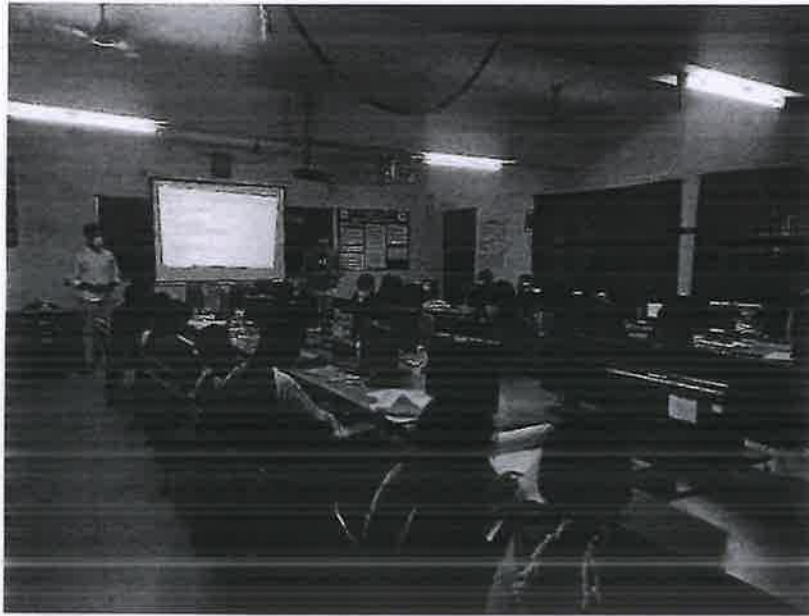

ATTESTED

[Signature]
Dr. S. RAMABALAN, M.E., Ph.D.,
PRINCIPAL
E.G.S. Pillay Engineering College,
Thethi, Nagore - 611 002,
Nagapattinam (Dt) Tamil Nadu.



E.G.S. PILLAY ENGINEERING COLLEGE
 (An Autonomous Institution, Affiliated to Anna University, Chennai)
 Nagore Post, Nagapattinam – 611 002, Tamilnadu.
Department of Electronics and Communication Engineering

Three Days Faculty Development Program on

MATLAB and its Applications

Attendance Form (10.12.2018 to 12.12.2018)

Class: II Year ECE A & B

Venue: SJ Block – SJB 105 – DSP/VLSI/EMBEDDED LAB

Registerno	Name of the Staff	Signature(10.12.2018)		Signature(11.12.2018)		Signature(12.12.2018)	
		Forenoon (FN)	Afternoon (AN)	Forenoon (FN)	Afternoon (AN)	Forenoon (FN)	Afternoon (AN)
E17ECR001	AAKASH R	<i>Aakash</i>	<i>Aakash</i>	<i>Aakash</i>	<i>Aakash</i>	<i>Aakash</i>	<i>Aakash</i>
E17ECR002	ABEENAYA P P	<i>Abeenaya PP</i>	<i>Abeenaya PP</i>	<i>Abeenaya PP</i>	<i>Abeenaya PP</i>	<i>Abeenaya PP</i>	<i>Abeenaya PP</i>
E17ECR003	ABINAYA S (25/03/1999)	<i>Abinaya</i>	<i>Abinaya</i>	<i>Abinaya</i>	<i>Abinaya</i>	<i>Abinaya</i>	<i>Abinaya</i>
E17ECR004	ABINAYA S (18/07/2000)	<i>Abinaya</i>	<i>Abinaya</i>	<i>Abinaya</i>	<i>Abinaya</i>	<i>Abinaya</i>	<i>Abinaya</i>
E17ECR005	ABINESH T	<i>Abinaya</i>	<i>Abinaya</i>	<i>Abinaya</i>	<i>Abinaya</i>	<i>Abinaya</i>	<i>Abinaya</i>
E17ECR006	ADHEESEN S	<i>S. Adheesen</i>	<i>S. Adheesen</i>	<i>S. Adheesen</i>	<i>S. Adheesen</i>	<i>S. Adheesen</i>	<i>S. Adheesen</i>
E17ECR007	AGALYA A	<i>Agalya</i>	<i>Agalya</i>	<i>Agalya</i>	<i>Agalya</i>	<i>Agalya</i>	<i>Agalya</i>
E17ECR008	AHAMED NACHIYAR A	<i>A. Ahmed</i>	<i>A. Ahmed</i>	<i>A. Ahmed</i>	<i>A. Ahmed</i>	<i>A. Ahmed</i>	<i>A. Ahmed</i>
E17ECR009	AKASH A (18/06/2000)	<i>A. Akash</i>	<i>A. Akash</i>	<i>A. Akash</i>	<i>A. Akash</i>	<i>A. Akash</i>	<i>A. Akash</i>
E17ECR010	AKASH A (11/08/2000)	<i>A. Akash</i>	<i>A. Akash</i>	<i>A. Akash</i>	<i>A. Akash</i>	<i>A. Akash</i>	<i>A. Akash</i>
E17ECR011	AKASH R	<i>Aakash</i>	<i>Aakash</i>	<i>Aakash</i>	<i>Aakash</i>	<i>Aakash</i>	<i>Aakash</i>
E17ECR012	AMRISH BHARATHY M	<i>Amrisha</i>	<i>Amrisha</i>	<i>Amrisha</i>	<i>Amrisha</i>	<i>Amrisha</i>	<i>Amrisha</i>
E17ECR013	ANANTHA KUMAR T	<i>Anantha</i>	<i>Anantha</i>	<i>Anantha</i>	<i>Anantha</i>	<i>Anantha</i>	<i>Anantha</i>
E17ECR014	ANUSHA S	<i>Anusha</i>	<i>Anusha</i>	<i>Anusha</i>	<i>Anusha</i>	<i>Anusha</i>	<i>Anusha</i>
E17ECR015	ARAVIND S DR. S. RAMABALAN, M.E., Ph.D.	<i>Aravind</i>	<i>Aravind</i>	<i>Aravind</i>	<i>Aravind</i>	<i>Aravind</i>	<i>Aravind</i>
E17ECR016	ARUN PRASATH G.S. Pillay Engineering College, Thethi, Nagore - 611 002. Nagapattinam (Dt) Tamil Nadu.	<i>Arun Prasad</i>	<i>Arun Prasad</i>	<i>Arun Prasad</i>	<i>Arun Prasad</i>	<i>Arun Prasad</i>	<i>Arun Prasad</i>

ATTESTED

DR. S. RAMABALAN, M.E., Ph.D.
 PRINCIPAL

Thethi, Nagore - 611 002.
 Nagapattinam (Dt) Tamil Nadu.



E.G.S. PILLAY ENGINEERING COLLEGE

(An Autonomous Institution, Affiliated to Anna University, Chennai)
Nagore Post, Nagapattinam - 611 002, Tamilnadu.

Department of Electronics and Communication Engineering

Three Days Faculty Development Program on

MATLAB and its Applications

Attendance Form (10.12.2018 to 12.12.2018)

Registerno	Name of the Staff	Signature(10.12.2018)		Signature(11.12.2018)		Signature(12.12.2018)	
		Forenoon (FN)	Afternoon (AN)	Forenoon (FN)	Afternoon (AN)	Forenoon (FN)	Afternoon (AN)
E17ECR017	ARUNKUMAR V	V. Arunkumar	V. Arunkumar	V. Arunkumar	V. Arunkumar	V. Arunkumar	V. Arunkumar
E17ECR018	ARUNTHATHI I	I. Arunthathi	I. Arunthathi	I. Arunthathi	I. Arunthathi	I. Arunthathi	I. Arunthathi
E17ECR019	ASHWITHA S	S. Ashwitha	S. Ashwitha	S. Ashwitha	S. Ashwitha	S. Ashwitha	S. Ashwitha
E17ECR021	BALAYOGESH E	E. Balayogesh	E. Balayogesh	E. Balayogesh	E. Balayogesh	E. Balayogesh	E. Balayogesh
E17ECR022	CELSIYA B	B. Celsiya	B. Celsiya	B. Celsiya	B. Celsiya	B. Celsiya	B. Celsiya
E17ECR024	DEEPIKA G	G. Deepika	G. Deepika	G. Deepika	G. Deepika	G. Deepika	G. Deepika
E17ECR025	DEEPIKA S(17/07/1999)	S. Deepika	S. Deepika	S. Deepika	S. Deepika	S. Deepika	S. Deepika
E17ECR026	DEEPIKA S (01/01/2000)	S. Deepika	S. Deepika	S. Deepika	S. Deepika	S. Deepika	S. Deepika
E17ECR027	DHINAKARAN K	K. Dhinakaran	K. Dhinakaran	K. Dhinakaran	K. Dhinakaran	K. Dhinakaran	K. Dhinakaran
E17ECR028	DINESHKUMAR G	G. Dineshkumar	G. Dineshkumar	G. Dineshkumar	G. Dineshkumar	G. Dineshkumar	G. Dineshkumar
E17ECR029	DIVYA P	P. Divya	P. Divya	P. Divya	P. Divya	P. Divya	P. Divya
E17ECR030	DIVYA S	S. Divya	S. Divya	S. Divya	S. Divya	S. Divya	S. Divya
E17ECR031	FAHMIDHA FATHIN S	S. Fahmidha	S. Fahmidha	S. Fahmidha	S. Fahmidha	S. Fahmidha	S. Fahmidha
E17ECR032	GANGA DEVI K	K. Ganga Devi	K. Ganga Devi	K. Ganga Devi	K. Ganga Devi	K. Ganga Devi	K. Ganga Devi
E17ECR033	GAYATHRI S	S. Gayathri	S. Gayathri	S. Gayathri	S. Gayathri	S. Gayathri	S. Gayathri
E17ECR034	GEETHA S	S. Geetha	S. Geetha	S. Geetha	S. Geetha	S. Geetha	S. Geetha
E17ECR035	GNANAVEL M	M. Gnanavel	M. Gnanavel	M. Gnanavel	M. Gnanavel	M. Gnanavel	M. Gnanavel

ATTESTED
[Signature]
PRINCIPAL

Dr. S. RAMABALAN, M.E., Ph.D.
PRINCIPAL
E.G.S. Pillay Engineering College
Nagapattinam (Tamil Nadu)

Thethi, Nagore - 611 002.



E.G.S. PILLAY ENGINEERING COLLEGE
 (An Autonomous Institution, Affiliated to Anna University, Chennai)
 Nagore Post, Nagapattinam - 611 002, Tamilnadu.
Department of Electronics and Communication Engineering

Three Days Faculty Development Program on

MATLAB and its Applications

Attendance Form (10.12.2018 to 12.12.2018)

Registerno	Name of the Staff	Signature(10.12.2018)		Signature(11.12.2018)		Signature(12.12.2018)	
		Forenoon (FN)	Afternoon (AN)	Forenoon (FN)	Afternoon (AN)	Forenoon (FN)	Afternoon (AN)
E17ECR054	KEERTHANA R	R.Keerthana	R.Keerthana	R.Keerthana	R.Keerthana	R.Keerthana	R.Keerthana
E17ECR055	KEERTHIKA A	R.Keerthika	R.Keerthika	R.Keerthika	R.Keerthika	R.Keerthika	R.Keerthika
E17ECR056	KOWSALYA K	Kowsalya	Kowsalya	Kowsalya	Kowsalya	Kowsalya	Kowsalya
E17ECR057	LAKSHMI PRABA V	Lakshmi	Lakshmi	Lakshmi	Lakshmi	Lakshmi	Lakshmi
E17ECR058	LALU C	Lalu	Lalu	Lalu	Lalu	Lalu	Lalu
E17ECR059	MAHISHANTHINI M	Mahishanthini	Mahishanthini	Mahishanthini	Mahishanthini	Mahishanthini	Mahishanthini
E17ECR060	MANIKANDAN J	Manikandan	Manikandan	Manikandan	Manikandan	Manikandan	Manikandan
E17ECR061	MANIVASAGAN M	Manivasagan	Manivasagan	Manivasagan	Manivasagan	Manivasagan	Manivasagan
E17ECR062	MANJIVI FASHINI R	Manjivi	Manjivi	Manjivi	Manjivi	Manjivi	Manjivi
E17ECR063	MATHIVANAN A	Mathivanan	Mathivanan	Mathivanan	Mathivanan	Mathivanan	Mathivanan
E17ECR064	MAYAVATHI M	Mayavathi	Mayavathi	Mayavathi	Mayavathi	Mayavathi	Mayavathi
E17ECR065	MOHAMED ASFAR A	Asfar	Asfar	Asfar	Asfar	Asfar	Asfar
E17ECR066	MOHAMED JAWITH M	Jawith	Jawith	Jawith	Jawith	Jawith	Jawith
E17ECR067	MOHAMED SAFIRUDEEN H	Safirudeen	Safirudeen	Safirudeen	Safirudeen	Safirudeen	Safirudeen
E17ECR068	MOHAMED SAMEER B	Sameer	Sameer	Sameer	Sameer	Sameer	Sameer
E17ECR069	MOHANLAL KARAMSANTH S	Mohanlal	Mohanlal	Mohanlal	Mohanlal	Mohanlal	Mohanlal
E17ECR070	MUKILA N	Mukila	Mukila	Mukila	Mukila	Mukila	Mukila

ATTESTED

(Signature)

DR. S. RAMABALAN, M.E., Ph.D.

PRINCIPAL

E.G.S. Pillay Engineering College,
 Thethi, Nagore - 611 002,
 Nagapattinam (Dt) Tamil Nadu.



E.G.S. PILLAY ENGINEERING COLLEGE
 (An Autonomous Institution, Affiliated to Anna University, Chennai)
 Nagore Post, Nagapattinam - 611 002, Tamilnadu.
Department of Electronics and Communication Engineering

Three Days Faculty Development Program on

MATLAB and its Applications

Attendance Form (10.12.2018 to 12.12.2018)

Registerno	Name of the Staff	Signature(10.12.2018)		Signature(11.12.2018)		Signature(12.12.2018)	
		Forenoon (FN)	Afternoon (AN)	Forenoon (FN)	Afternoon (AN)	Forenoon (FN)	Afternoon (AN)
E17ECR071	MUTHUKUMARAN P	Muthu	Muthu	Muthu	Muthu	Muthu	Muthu
E17ECR072	NAJMINA T	Najmin	Najmin	Najmin	Najmin	Najmin	Najmin
E17ECR073	NANDHINI K	Nandhini	Nandhini	Nandhini	Nandhini	Nandhini	Nandhini
E17ECR074	NANTHANE	Nanthan	Nanthan	Nanthan	Nanthan	Nanthan	Nanthan
E17ECR075	NEYANA	Neyana	Neyana	Neyana	Neyana	Neyana	Neyana
E17ECR076	NIRMALADEVI R	Nirmala	Nirmala	Nirmala	Nirmala	Nirmala	Nirmala
E17ECR077	OVIYA R	Oviya	Oviya	Oviya	Oviya	Oviya	Oviya
E17ECR078	PADMA PRIYA S	Padma	Padma	Padma	Padma	Padma	Padma
E17ECR079	PARTHIBAN R	Parthi	Parthi	Parthi	Parthi	Parthi	Parthi
E17ECR080	PAVITHRA B	Pavi	Pavi	Pavi	Pavi	Pavi	Pavi
E17ECR081	PAVITHRA P	P.Pavithra	P.Pavithra	P.Pavithra	P.Pavithra	P.Pavithra	P.Pavithra
E17ECR082	PORKODI S	PARKODI	PARKODI	PARKODI	PARKODI	PARKODI	PARKODI
E17ECR083	PRADEEPA N	Pradeepa	Pradeepa	Pradeepa	Pradeepa	Pradeepa	Pradeepa
E17ECR084	PRADEEPA P	Pradeepa	Pradeepa	Pradeepa	Pradeepa	Pradeepa	Pradeepa
E17ECR085	PRASANNA K	Prasanna	Prasanna	Prasanna	Prasanna	Prasanna	Prasanna
E17ECR086	PRATHIZA S	S.Prathiza	S.Prathiza	S.Prathiza	S.Prathiza	S.Prathiza	S.Prathiza
E17ECR087	RABARKAN B	Rabarka	Rabarka	Rabarka	Rabarka	Rabarka	Rabarka

ATTESTED

(Signature)

Dr. S. RAMABALAN, M.E., Ph.D.
 PRINCIPAL

E.G.S. Pillay Engineering College,
 Thenni, Nagore - 611 002.
 Nagapattinam (Dt) Tamil Nadu.



E.G.S. PILLAY ENGINEERING COLLEGE

(An Autonomous Institution, Affiliated to Anna University, Chennai)
Nagore Post, Nagapattinam – 611 002, Tamilnadu.

Department of Electronics and Communication Engineering

Three Days Faculty Development Program on

MATLAB and its Applications

Attendance Form (10.12.2018 to 12.12.2018)

Registerno	Name of the Staff	Signature(10.12.2018)		Signature(11.12.2018)		Signature(12.12.2018)	
		Forenoon (FN)	Afternoon (AN)	Forenoon (FN)	Afternoon (AN)	Forenoon (FN)	Afternoon (AN)
E17ECR088	RAGAVISHAL R	[Signature]	[Signature]	[Signature]	[Signature]	[Signature]	[Signature]
E17ECR089	RAJESH R	[Signature]	[Signature]	[Signature]	[Signature]	[Signature]	[Signature]
E17ECR090	RAMMOHAN M	[Signature]	[Signature]	[Signature]	[Signature]	[Signature]	[Signature]
E17ECR091	RANJITHA R	[Signature]	[Signature]	[Signature]	[Signature]	[Signature]	[Signature]
E17ECR092	RANJITHA S	[Signature]	[Signature]	[Signature]	[Signature]	[Signature]	[Signature]
E17ECR093	SABITHA D	[Signature]	[Signature]	[Signature]	[Signature]	[Signature]	[Signature]
E17ECR094	SANTHI M	[Signature]	[Signature]	[Signature]	[Signature]	[Signature]	[Signature]
E17ECR095	SANTHIYA B	[Signature]	[Signature]	[Signature]	[Signature]	[Signature]	[Signature]
E17ECR096	SELVAKUMARI S	[Signature]	[Signature]	[Signature]	[Signature]	[Signature]	[Signature]
E17ECR097	SENTHAMARAI SELVI S	[Signature]	[Signature]	[Signature]	[Signature]	[Signature]	[Signature]
E17ECR098	SHALINI S	[Signature]	[Signature]	[Signature]	[Signature]	[Signature]	[Signature]
E17ECR099	SHOBICA P	[Signature]	[Signature]	[Signature]	[Signature]	[Signature]	[Signature]
E17ECR100	SINDUJA R	[Signature]	[Signature]	[Signature]	[Signature]	[Signature]	[Signature]
E17ECR101	SIVA C	[Signature]	[Signature]	[Signature]	[Signature]	[Signature]	[Signature]
E17ECR102	SIVASANKAR S. RAMABALAN, M.E., Ph.D. PRINCIPAL	[Signature]	[Signature]	[Signature]	[Signature]	[Signature]	[Signature]
E17ECR103	SNEHA M E.G.S. Pillay Engineering College, Nagore - 611 002.	[Signature]	[Signature]	[Signature]	[Signature]	[Signature]	[Signature]
E17ECR104	SOUNDHARYA G Nagapattinam (Dt) Tamil Nadu.	[Signature]	[Signature]	[Signature]	[Signature]	[Signature]	[Signature]

ATTESTED
[Signature]



E.G.S. PILLAY ENGINEERING COLLEGE
 (An Autonomous Institution, Affiliated to Anna University, Chennai)
 Nagore Pct, Nagapattinam - 611 002, Tamilnadu.
Department of Electronics and Communication Engineering

Three Days Faculty Development Program on

MATLAB and its Applications

Attendance Form (10.12.2018 to 12.12.2018)

Registerno	Name of the Staff	Signature(10.12.2018)		Signature(11.12.2018)		Signature(12.12.2018)	
		Forenoon (FN)	Afternoon (AN)	Forenoon (FN)	Afternoon (AN)	Forenoon (FN)	Afternoon (AN)
E17ECR105	SRIRAM V	Srinivasan	Srinivasan	Srinivasan	Srinivasan	Srinivasan	Srinivasan
E17ECR106	SUBASH S	S. Subash	S. Subash	S. Subash	S. Subash	S. Subash	S. Subash
E17ECR107	SUBASHREE P	P. Suba	P. Suba	P. Suba	P. Suba	P. Suba	P. Suba
E17ECR109	SUDHAN KUMAR N	N. Sudhan	N. Sudhan	N. Sudhan	N. Sudhan	N. Sudhan	N. Sudhan
E17ECR110	SUJITHA M	M. Sujitha	M. Sujitha	M. Sujitha	M. Sujitha	M. Sujitha	M. Sujitha
E17ECR111	SUMOGANA N	N. Sumogana	N. Sumogana	N. Sumogana	N. Sumogana	N. Sumogana	N. Sumogana
E17ECR112	SURYA R	R. Surya	R. Surya	R. Surya	R. Surya	R. Surya	R. Surya
E17ECR113	SURYA PRAKASH B	B. Surya	B. Surya	B. Surya	B. Surya	B. Surya	B. Surya
E17ECR114	SUSIMA M	M. Susima	M. Susima	M. Susima	M. Susima	M. Susima	M. Susima
E17ECR116	THIYAGARAJAN DINESH K	K. Thyagarajan	K. Thyagarajan	K. Thyagarajan	K. Thyagarajan	K. Thyagarajan	K. Thyagarajan
E17ECR117	THIRUTHANIGAINATHAN K	K. Thiruthaniganathan	K. Thiruthaniganathan	K. Thiruthaniganathan	K. Thiruthaniganathan	K. Thiruthaniganathan	K. Thiruthaniganathan
E17ECR118	VALLARASU K	K. Vallarasu	K. Vallarasu	K. Vallarasu	K. Vallarasu	K. Vallarasu	K. Vallarasu
E17ECR119	VEERAMANI N	N. Veeramani	N. Veeramani	N. Veeramani	N. Veeramani	N. Veeramani	N. Veeramani
E17ECR120	VIGNESH D	D. Vignesh	D. Vignesh	D. Vignesh	D. Vignesh	D. Vignesh	D. Vignesh
E17ECR121	VIGNESH M. S. RAMABALAN, M.E., Ph.D.,	M. S. Ramabalan	M. S. Ramabalan	M. S. Ramabalan	M. S. Ramabalan	M. S. Ramabalan	M. S. Ramabalan
E17ECR122	VIGNESHWARAN T	T. Vigneshwaran	T. Vigneshwaran	T. Vigneshwaran	T. Vigneshwaran	T. Vigneshwaran	T. Vigneshwaran
E17ECR123	VINOPRIYA B	B. Vinopriya	B. Vinopriya	B. Vinopriya	B. Vinopriya	B. Vinopriya	B. Vinopriya

ATTESTED

Dr. S. RAMABALAN, M.E., Ph.D.,
 PRINCIPAL
 E.G.S. Pillay Engineering College,
 Thethi, Nagore - 611 002.
 Nagapattinam (Dt) Tamil-Nadu.



E.G.S. PILLAY ENGINEERING COLLEGE
(An Autonomous Institution, Affiliated to Anna University, Chennai)
Nagore Post, Nagapattinam – 611 002, Tamilnadu.
Department of Electronics and Communication Engineering

Three Days Faculty Development Program on
MATLAB and its Applications

Attendance Form (10.12.2018 to 12.12.2018)

Registerno	Name of the Staff	Signature(10.12.2018)		Signature(11.12.2018)		Signature(12.12.2018)	
		Forenoon (FN)	Afternoon (AN)	Forenoon (FN)	Afternoon (AN)	Forenoon (FN)	Afternoon (AN)
E17ECL124	VINOTH KUMAR D	Vinothkumar	Vinothkumar	Vinothkumar	Vinothkumar	Vinothkumar	Vinothkumar
E17ECL125	VINOTHA K	K. Vinatha	K. Vinatha	K. Vinatha	K. Vinatha	K. Vinatha	K. Vinatha
E17ECL126	YOGESHWAR T	Yogeshwar	Yogeshwar	Yogeshwar	Yogeshwar	Yogeshwar	Yogeshwar
E17ECL301	AGALYA T	T. Agalya	T. Agalya	T. Agalya	T. Agalya	T. Agalya	T. Agalya
E17ECL302	DURAI RAJ B	B. Durairaj	B. Durairaj	B. Durairaj	B. Durairaj	B. Durairaj	B. Durairaj
E17ECL303	KAVIYARASAN B	Kaviyarasam	Kaviyarasam	Kaviyarasam	Kaviyarasam	Kaviyarasam	Kaviyarasam
E17ECL304	KEERTHANA G	G. Keerthana	G. Keerthana	G. Keerthana	G. Keerthana	G. Keerthana	G. Keerthana
E17ECL305	NANDHINI M	M. Nandhini	M. Nandhini	M. Nandhini	M. Nandhini	M. Nandhini	M. Nandhini
E17ECL306	UMASANKAR	UMASANKAR	UMASANKAR	UMASANKAR	UMASANKAR	UMASANKAR	UMASANKAR
E17ECL307	VIKASH VIKNESH S S	S. Vikash Viknesh	S. Vikash Viknesh	S. Vikash Viknesh	S. Vikash Viknesh	S. Vikash Viknesh	S. Vikash Viknesh
	Total No. of Present	NIL		NIL		NIL	
	Total No. of Absent	NIL		NIL		NIL	

ATTESTED

Dr. S. RAMABALAN, M.E., Ph.D.,
PRINCIPAL

E.G.S. Pillay Engineering College,
Thethi, Nagore - 611 002.
Nagapattinam (Dt) Tamil Nadu,



E.G.S. Pillay Engineering College (Autonomous)
Nagapattinam-611 002.
Tamil nadu, India.

(Accredited by NBA & NAAC. An ISO 9001-2015
Certified Institution, Affiliated to Anna University, Chennai, Tamil nadu, India)

Department Of
Electronics and Communication Engineering

Organizes

VALUE ADDED COURSE
ON

“BASICS OF PYTHON PROGRAMMING”

18th OCTOBER 2021 to 22nd OCTOBER 2021

REPORT

One Day Webinar on “BASICS OF PYTHON PROGRAMMING”, has been conducted and organized by Department of Electronics and Communication Engineering sponsored by, E.G.S. Pillay Engineering College, Nagapattinam. The Programme was inaugurated in the fine morning on 18th OCTOBER, 2021.

The one of co-ordinator **Mrs.S.Chitra**, started this course with her welcome address. Head of the department **Dr.B.Padmanban** gave the keynote address. Our resource person **Mrs.Dhivya Mohan – IT Analyst, Tata Consultancy Services-Bangalore**, has explicated about Introduction to Python, Variable, Comment, Operators, Conditional Statement, Loops and break, OPPTS in Python(Polymorphism, Inheritance, Encapsulation), File handling.

Finally, on 22nd OCTOBER, 2021 Evening 6'o clock, Programme came to close with the summary of the whole programme was given by **Mr.T.Senthil Kumar**, Coordinator proposed vote of thanks.

ATTESTED

Dr. S. RAMABALAN, M.E., Ph.D.,
PRINCIPAL
E.G.S. Pillay Engineering College,
Thethi, Nagore - 611 002.
Nagapattinam (Dt) Tamil Nadu.

11.10.2021

From

Mrs.S.Chitra, Assistant Professor,
Mr.T.Senthil Kumar, Assistant Professor,
Department of ECE,
E.G.S. Pillay Engineering College,
Nagapattinam.

To

The Principal,
E.G.S. Pillay Engineering College,
Nagapattinam.

SP
11/10/21

Respected Sir,

Sub: Requisition to conduct Value added Course- Reg.

We planned to conduct Five days value added Course on "Basics of Python Programming" for ECE students dated on 18.10.2021 to 22.10.2021. So, we request you to give the permission for this.

Thanking you,

Your's Faithfully

S.Chitra
(S.Chitra) 11/10/21

T.Senthil Kumar
(T.senthil Kumar)

Date: 15.09.2022

Place: EGSPEC, Nagapattinam

Forwarded
to
Principal
SP
11/10/21

ATTESTED

SP
Dr. S. RAMABALAN, M.E., Ph.D.,
PRINCIPAL
E.G.S. Pillay Engineering College,
Thethi, Nagore - 611 002.
Nagapattinam (Dt) Tamil Nadu.

11.10.2021

From

Dr.B.Padmanaban,
Head of the department,
Department of ECE,
E.G.S. Pillay Engineering College,
Nagapattinam.

To

Mrs.Dhivya Mohan,
IT Analyst,
Tata Consultancy and Services,
Bangalore.

BP
11/10/21

Respected Sir ,

Sub: Requisition to depute **"Mrs.Dhivya Mohan – IT Analyst"** for **Five days value added Course – Reg.**

Respected Sir,

I am very glad to share that, we are going to organize Five Days Value added Course on **"Basics of Python Programming"** which is scheduled from 18/10/2021 22/10/2021. In connection with this, it will be a great pleasure for us to depute **"Mrs.Dhivya Mohan – IT Analyst"** to address the title on **"Basics of Python Programming"**.

Thanking you,

Date: 11.10.2021

Place: EGSPEC, Nagapattinam

ATTESTED

[Signature]

Dr. S. RAMABALAN, M.E., Ph.D.,
PRINCIPAL
E.G.S. Pillay Engineering College,
Thethi, Nagoze - 611 002.
Nagapattinam (Dt) Tamil Nadu.

[Signature] 11/10/21
Your's Faithfully

(Dr.B.Padmanaban)

12.10.2021

From

Mrs.Dhivya Mohan,
IT Analyst,
Tata Consultancy and Services,
Bangalore.

To

Dr. B.Padmanaban,
Head of the department,
Department of ECE,
E.G.S. Pillay Engineering College,
Nagapattinam.

Respected Sir,

Sub: Acceptance of resource person - - **Reg.**

Respected Sir,

I am very happy to see your letter about to deliver a lecture on "**Basics of Python Programming**" as a resource person to your students. My project team leader gave permission to me for this course. From this letter I confirm my present on 18.10.2021.

Thanking you,

Your's Faithfully

(Mrs.Dhivya Mohan)

Date: 12.10.2021

Place: Bangalore.

ATTESTED

Dr. S. RAMABALAN, M.E., Ph.D.,
PRINCIPAL
E.G.S. Pillay Engineering College,
Thethi, Nagore - 611 002.
Nagapattinam (Dt) Tamil Nadu.



**E.G.S. PILLAY ENGINEERING COLLEGE, NAGAPATTINAM
(AUTONOMOUS)**

Department of Electronics and Communication Engineering

(Accredited by NAAC with 'A' grade || Recognized by DSIR || Recognized by UGC 2(f) & 12 (B)||Provisional Accreditation in NBA for EEE, CSE and Mechanical || Approved by AICTE, New Delhi & Affiliated to Anna University, Chennai)

**Value Added Course on
"Basics of Python Programming"**

Date: 11.10.2021

BUDGET REQUIREMENT

S.No	Particulars	Amount Required (In Rs.)
01	Resource person honorarium	4,000/-
TOTAL		4,000/-

**Coordinators
(S.Chitra)
(T.Senthil Kumar)**

HOD 11/10/21
(Dr. B. Padmanaban)

ATTESTED

**Dr. S. RAMABALAN, M.E., Ph.D.,
PRINCIPAL**
E.G.S. Pillay Engineering College,
Thethi, Nagore - 611 002.
Nagapattinam (Dt) Tamil Nadu.

THE SECRETARY, PRINCIPAL, DEAN, HEADS, FACULTY MEMBERS &
STUDENTS ARE CORDIALLY INVITES YOU TO



WEBINAR

on

Basics of Python Programming
(18/10/2021 to 22/10/2021)

Date: 18/10/2021 @ 9.00AM

Venue: ECE Seminar Hall

CHIEF GUESTS

Mrs.Dhivya Mohan,
IT Analyst,
Tata Consultancy and Services,
Bangalore.

Smt. S. Jothimani G.S. Pillay
Chairman – E.G.S. Pillay Group of Institutions

Mr.S.Senthil Kumar
Secretary - E.G.S. Pillay Group of Institutions

Mr.S.Sankar Ganesh
Joint Secretary - E.G.S. Pillay Group of
Institutions

Dr. S. Ramabalan
Principal, E.G.S. Pillay Engineering College

Dr.B.Padmanaban
HoD - ECE, E.G.S. Pillay Engineering College

Mrs.S.Chitra
AP - ECE, E.G.S. Pillay Engineering College

Mr.T.Senthil Kumar
AP - ECE, E.G.S. Pillay Engineering College

Organized by

Department of Electronics and
Communication Engineering

E.G.S. PILLAY ENGINEERING COLLEGE (AUTONOMOUS)
NAGAPATTINAM – 611 002

(Approved by AICTE, New Delhi | Affiliated to Anna University, Chennai | NBA All Accredited Programmes
| Accredited by NAAC with 'A' Grade | Recognized by DSIR | An ISO 9001:2015 Certified
Institution)

Dr. S. RAMABALAN, M.E., Ph.D.,
PRINCIPAL

E.G.S. Pillay Engineering College,
Thethi, Nagore - 611 002.
Nagapattinam (Dt) Tamil Nadu.

AGENDA

- Welcome Address : Mrs.S.Chitra, AP – ECE
- Introducing Chief Guest : Dr. B.Padmanaban, HOD - ECE
- Special address : Dr. S. Ramabalan – Principal
- Felicitation address :Mr.C.Mathuvanesan, AP – ECE
- Keynote Presentation
by Chief Guest : Mrs.Dhivya Mohan, IT Analyst,Tata Consultancy Services.

SESSION DETAILS

Date	Expert Details	Lecture title
18.10.2021 to 22.10.21	Mrs. Dhivya Mohan, IT Analyst, Tata Consultancy and Services, Bangalore.	Introduction to Python, Variable, Comment, Operators, Conditional Statement, Loops and break, OPSS in Python(Polymorphism, Inheritance, Encapsulation), File handling

Participants feedback collection : Mr.M.Nuthal Srinivasan, AP-ECE

Vote of thanks : Mr.S.Senthil Kumar, AP - ECE

National Anthem

ATTESTED
Prof.
Dr. S. RAMABALAN, M.E., Ph.D.,
PRINCIPAL
E.G.S. Pillay Engineering College,
Thethi. Nagore - 611 002.
Nagapattinam. (Dt) Tamil Nadu.

you are
Cordially invited



**E.G.S. PILLAY ENGINEERING COLLEGE, NAGAPATTINAM
(AUTONOMOUS)**

Department of Electronics and Communication Engineering

(Accredited by NAAC with 'A' grade || Recognized by DSIR || Recognized by UGC 2(f) & 12 (B)||Provisional Accreditation in NBA for EEE, CSE and Mechanical || Approved by AICTE, New Delhi & Affiliated to Anna University, Chennai)

**Value Added Course on
"Basics of Python Programming"**

ECE//2021/ODD/CIRCULAR-01

DEPARTMENT CIRCULAR DATED 12.10.2021

To enhance the practical Skills to face Interview and Some needed abilities of our ECE students, we are going to conduct value added Course on "Basics of Python Programming" on 18.10.2021 to 21.10.2021.

OBJECTIVE

An effort to create awareness on Python Programming. To enhance the practical Skills to face Interview and Some needed abilities.

Days	Participants	EVENT	RESOURCE PERSON
18.10.2021 to 22.10.21	II ECE Students	<ul style="list-style-type: none">• Introduction to Python,• Variable, Comment,• Operators, Conditional Statement, Loops and break,• OPPS in Python(Polymorphism, Inheritance, Encapsulation),• File handling	

Program Co-ordinators

1. S.Chithra
2. T.Senthil Kumar

Dr. B. Padmanaban
HOD/ECE 12/10/21

Dr.B.Padmanaban

ATTESTED
Dr. S. Ramabalan
**Dr. S. RAMABALAN, M.E., Ph.D.,
PRINCIPAL
E.G.S. Pillay Engineering College,
Thethi, Nagore - 611 002.
Nagapattinam (Dt) Tamil Nadu.**



**E.G.S. PILLAY ENGINEERING COLLEGE, NAGAPATTINAM
(AUTONOMOUS)**

Department of Electronics and Communication Engineering



(Accredited by NAAC with 'A' grade || Recognized by DSIR || Recognized by UGC 2(f) & 12 (B)||Provisional Accreditation in NBA for EEE, CSE and Mechanical || Approved by AICTE, New Delhi & Affiliated to Anna University, Chennai)

Value Added Course on

“Basics of Python Programming”

COMMITTEE LIST

Sl. No	Name of the Committee	Committee Representative	Student's Members	Responsibilities
1	Overall Program Coordination	Mrs.S.Chitra Mr. T.Senthil Kumar	NIRMAL ANAND.K PAVITHRA.P	Invitation, Brochure, Report Preparation, Programme schedule and Overall Control
2	Comparing	Mrs.K.K.Sandhoshshree	LAKSHMI PRIYA.B RAGU.B	Comparing for Inauguration and Valediction, Chief Guest honour.
3	Registration	Mr.S.Senthil Kumar Dr.D.Devarajan	ABITHA.V AKSAYA.B	Registration, Attendance, Feedback & Certificate design.
4	PRO	Mr.L.Ramachandran Mr.M.Nuthal Srinivasan	KAMALESH.S RANJITH.S	Photo Session ,welcome



Coordinators
(Mrs.S.Chitra)
(Mr. T.Senthil Kumar)

HoD
(Dr.B.Padmanban)

ATTESTED

**Dr. S. RAMABALAN, M.E., Ph.D.,
PRINCIPAL**
E.G.S. Pillay Engineering College,
Thethi, Nagore - 611 002.
Nagapattinam (Dt) Tamil Nadu.



**E.G.S. PILLAY ENGINEERING COLLEGE, NAGAPATTINAM
(AUTONOMOUS)**

Department of Electronics and Communication Engineering

(Accredited by NAAC with 'A' grade || Recognized by DSIR || Recognized by UGC 2(f) & 12 (B) || Provisional Accreditation in NBA for EEE, CSE and Mechanical || Approved by AICTE, New Delhi & Affiliated to Anna University, Chennai)

**Value Added Course on
"Basics of Python Programming"**

Student Attendance

SNO	REG NO	NAME	23.8.21	24.8.21	25.8.21	26.8.21	27.8.21
1	E19ECR001	AARTHI.R	R. Arthi	R. Arthi	R. Arthi	R. Arthi	R. Arthi
2	E19ECR002	ABI BHARATHI.H	Abi Bharathi	Abi Bharathi	Abi Bharathi	Abi Bharathi	Abi Bharathi
3	E19ECR003	ABILASH.U	Abilash	Abilash	Abilash	Abilash	Abilash
4	E19ECR004	ABINAYA.A	Abinaya	Abinaya	Abinaya	Abinaya	Abinaya
5	E19ECR005	ABINAYA.K	Abinaya	Abinaya	Abinaya	Abinaya	Abinaya
6	E19ECR006	ABITHA.V	Abitha	Abitha	Abitha	Abitha	Abitha
7	E19ECR007	AJAY.S	Ajay	Ajay	Ajay	Ajay	Ajay
8	E19ECR008	AJAY.S	Ajay	Ajay	Ajay	Ajay	Ajay
9	E19ECR009	AJITH KUMAR.M	Ajith	Ajith	Ajith	Ajith	Ajith
10	E19ECR010	AJITH.M	Ajith	Ajith	Ajith	Ajith	Ajith
11	E19ECR011	AKASH.	Akash	Akash	Akash	Akash	Akash
12	E19ECR012	AKBAR ALI.A	Akbar	Akbar	Akbar	Akbar	Akbar
13	E19ECR013	AKSAYA.B	Aksaya	Aksaya	Aksaya	Aksaya	Aksaya
14	E19ECR014	ANDRO EDWIN.A	Andro	Andro	Andro	Andro	Andro
15	E19ECR015	ARAVIND KUMAR.R	Aravind	Aravind	Aravind	Aravind	Aravind
16	E19ECR016	ARSHATH AMBERUDEN.H	Arshath	Arshath	Arshath	Arshath	Arshath
17	E19ECR017	DR.S.RAMABALAN, M.E., Ph.D.	S. Ramabalan	S. Ramabalan	S. Ramabalan	S. Ramabalan	S. Ramabalan

PRINCIPAL

**E.G.S. Pillay Engineering College,
Thethi, Nagore - 611 002.
Nagapattinam (Dt) Tamil Nadu.**

18	E19ECR018	ASWATHAMAN.E	E. Anantha	E. Anantha	E. Anantha	E. Anantha	E. Anantha	E. Anantha
19	E19ECR019	ASWIN SARAVANAN.R	R. Aravinth	R. Aravinth	R. Aravinth	R. Aravinth	R. Aravinth	R. Aravinth
20	E19ECR021	DEENATHAYALAN.R	S. Dhya	S. Dhya	S. Dhya	S. Dhya	S. Dhya	S. Dhya
21	E19ECR022	DHIVYA. S.	S. Dhya	S. Dhya	S. Dhya	S. Dhya	S. Dhya	S. Dhya
22	E19ECR023	DIVYA.V	Chandana.V	Chandana.V	Chandana.V	Chandana.V	Chandana.V	Chandana.V
23	E19ECR024	DURGAM	M. Durgam	M. Durgam	M. Durgam	M. Durgam	M. Durgam	M. Durgam
24	E19ECR025	EASWARAN.AT	A. Easwar	A. Easwar	A. Easwar	A. Easwar	A. Easwar	A. Easwar
25	E19ECR027	GANESH.R	R. Ganesh	R. Ganesh	R. Ganesh	R. Ganesh	R. Ganesh	R. Ganesh
26	E19ECR028	GANESH MOORTHY.A	Ganesh	Ganesh	Ganesh	Ganesh	Ganesh	Ganesh
27	E19ECR030	GOPI ARASU.A	A. Ganesh	A. Ganesh	A. Ganesh	A. Ganesh	A. Ganesh	A. Ganesh
28	E19ECR031	GOWTHAM.M	N. Gowtham	N. Gowtham	N. Gowtham	N. Gowtham	N. Gowtham	N. Gowtham
29	E19ECR032	HARI RAM PRASATH	H.R.	H.R.	H.R.	H.R.	H.R.	H.R.
30	E19ECR033	HARIS KUMAR.R	H.R.	H.R.	H.R.	H.R.	H.R.	H.R.
31	E19ECR034	HARI VENKATESH.N	H.V.	H.V.	H.V.	H.V.	H.V.	H.V.
32	E19ECR035	HASIYATHUL NAFIYA.H	H. Hasitha	H. Hasitha	H. Hasitha	H. Hasitha	H. Hasitha	H. Hasitha
33	E19ECR036	JAIPOORNA.S	J.P.	J.P.	J.P.	J.P.	J.P.	J.P.
34	E19ECR037	JANANI.R	J. Janani	J. Janani	J. Janani	J. Janani	J. Janani	J. Janani
35	E19ECR038	JANANI.S	J. Janani	J. Janani	J. Janani	J. Janani	J. Janani	J. Janani
36	E19ECR039	JAYANTHI.K	J. Jayanthi	J. Jayanthi	J. Jayanthi	J. Jayanthi	J. Jayanthi	J. Jayanthi
37	E19ECR042	JAYASURYA.M	J. Jayasurya	J. Jayasurya	J. Jayasurya	J. Jayasurya	J. Jayasurya	J. Jayasurya
38	E19ECR043	JAYSRIANI.R	J. Jaysriani	J. Jaysriani	J. Jaysriani	J. Jaysriani	J. Jaysriani	J. Jaysriani
39	E19ECR045	KAMALESH.S	K. Kamal	K. Kamal	K. Kamal	K. Kamal	K. Kamal	K. Kamal
40	E19ECR046	KARTHIK.L	K. Karthik	K. Karthik	K. Karthik	K. Karthik	K. Karthik	K. Karthik
41	E19ECR047	KEERTHIKA.S	K. Keerthika	K. Keerthika	K. Keerthika	K. Keerthika	K. Keerthika	K. Keerthika
42	E19ECR048	KISHORE.A	K. Kishore	K. Kishore	K. Kishore	K. Kishore	K. Kishore	K. Kishore
43	E19ECR049	LAKSHMI PRIYA.B	L. Lakshmi Priya	L. Lakshmi Priya	L. Lakshmi Priya	L. Lakshmi Priya	L. Lakshmi Priya	L. Lakshmi Priya
44	E19ECR051	LOKESWARAN.S	L. Lokeshwar	L. Lokeshwar	L. Lokeshwar	L. Lokeshwar	L. Lokeshwar	L. Lokeshwar
45	E19ECR052	MADHUMITHA.C	M. Madhumitha	M. Madhumitha	M. Madhumitha	M. Madhumitha	M. Madhumitha	M. Madhumitha
46	E19ECR053	MAHENDRAN.B	M. Mahendran	M. Mahendran	M. Mahendran	M. Mahendran	M. Mahendran	M. Mahendran
47	E19ECR054	MAHESHWARAN	M. Maheshwara	M. Maheshwara	M. Maheshwara	M. Maheshwara	M. Maheshwara	M. Maheshwara
48	E19ECR055	MALA AKHESHTED	M. Malaksheshta	M. Malaksheshta	M. Malaksheshta	M. Malaksheshta	M. Malaksheshta	M. Malaksheshta
49	E19ECR056	MANIKANDAN.V	M. Manikandan	M. Manikandan	M. Manikandan	M. Manikandan	M. Manikandan	M. Manikandan

Dr. S. RAMABALAN, M.E., Ph.D.,
PRINCIPAL

E.G.S. Pillay Engineering College,
Thethi, Nagore - 611 002.

Sl. No.	Roll No.	Name	Marked	Marked	Marked
50	E19ECR057	MANIKANDAN.A			
51	E19ECR058	MANIMUTHU.D	D. Mani	D. Mani	D. Mani
52	E19ECR059	MOHAMMED SITHIK S	S. Siva	S. Siva	S. Siva
53	E19ECR060	MULLAI VENDHAN.D	D. Mani	D. Mani	D. Mani
54	E19ECR061	MUSARATH FARSANA.M	M. Siva	M. Siva	M. Siva
55	E19ECR062	MUTHU ARVIN.S	M. Siva	M. Siva	M. Siva
56	E19ECR063	NAVEEN.S	Naveen.S	Naveen.S	Naveen.S
57	E19ECR064	NIRMAL ANAND.K	N. Anand	N. Anand	N. Anand
58	E19ECR065	NITHIYA BALA.K	N. Balakrishnan	N. Balakrishnan	N. Balakrishnan
59	E19ECR066	PAUL NEVIL.P	P. Paul	P. Paul	P. Paul
60	E19ECR067	PAVITHRA.P	P. Parthi	P. Parthi	P. Parthi
61	E19ECR069	PRADEEP.M	M. Pradeep	M. Pradeep	M. Pradeep
62	E19ECR070	PRADEEP.S	S. Pradeep	S. Pradeep	S. Pradeep
63	E19ECR071	PRAKSHA	P. Prakash	P. Prakash	P. Prakash
64	E19ECR072	PRASANTH.N	P. Prashanth	P. Prashanth	P. Prashanth
65	E19ECR073	PRIYADHARSHINI	P. Priyadharshini	P. Priyadharshini	P. Priyadharshini
66	E19ECR074	PRIYANKA.M	P. Priyanka	P. Priyanka	P. Priyanka
67	E19ECR075	RAGU.B	B. Raghu	B. Raghu	B. Raghu
68	E19ECR076	RAJESH KUMAR.M	M. Rajesh	M. Rajesh	M. Rajesh
69	E19ECR077	REXY JENIFER.J	J. Jenifer	J. Jenifer	J. Jenifer
70	E19ECR078	RUTHRA GIRI.S	S. Ruthra	S. Ruthra	S. Ruthra
71	E19ECR079	SABARINATHAN.S	S. Sabarinathan	S. Sabarinathan	S. Sabarinathan
72	E19ECR080	SAI SIVA SANKAR.K	K. Siva Sankar	K. Siva Sankar	K. Siva Sankar
73	E19ECR081	SAKTHIBALAN.S	S. Sakthibalan	S. Sakthibalan	S. Sakthibalan
74	E19ECR082	SANJAY.R	R. Sanjay	R. Sanjay	R. Sanjay
75	E19ECR083	SANJEEVI RAMAN.B	B. Sanjeevi Raman	B. Sanjeevi Raman	B. Sanjeevi Raman
76	E19ECR084	SANTHOSH.A	A. Santhosh	A. Santhosh	A. Santhosh
77	E19ECR085	SARADHAPRIYA.K	K. Saradhapriya	K. Saradhapriya	K. Saradhapriya
78	E19ECR086	SARAN.V	V. Saran	V. Saran	V. Saran
79	E19ECR087	SARAVANAN.S	S. Saravanan	S. Saravanan	S. Saravanan
80	E19ECR088	SATTIESWARAN	S. Sattieswaran	S. Sattieswaran	S. Sattieswaran
81	E19ECR090	SINDHEE.A.S	A. Sindhee	A. Sindhee	A. Sindhee
82	E19ECR091	DR.S. RAMAKRISHNAN.M.E., Ph.D., PRINCIPAL	S. Ramakrishnan	S. Ramakrishnan	S. Ramakrishnan

DR.S. RAMAKRISHNAN
PRINCIPAL
 E.G.S. Pillay Engineering College,
 Thethi, Nagore - 611 092.
 Alagappa University, Tamil Nadu.

83	E19ECR092	SIVARANJANI.M	M. Sathi	M. Sathi	M. Sathi	M. Sathi	M. Sathi	M. Sathi	M. Sathi
84	E19ECR093	SOPHIA.V	V. Sathya	V. Sathya	V. Sathya	V. Sathya	V. Sathya	V. Sathya	V. Sathya
85	E19ECR094	SRIDEVI.J	J. Sridevi	J. Sridevi	J. Sridevi	J. Sridevi	J. Sridevi	J. Sridevi	J. Sridevi
86	E19ECR096	SRUTHI.S	S. Sathi	S. Sathi	S. Sathi	S. Sathi	S. Sathi	S. Sathi	S. Sathi
87	E19ECR098	SUBALAKSHMI.S	S. Sathi	S. Sathi	S. Sathi	S. Sathi	S. Sathi	S. Sathi	S. Sathi
88	E19ECR101	SWETHA.S	S. Sathi	S. Sathi	S. Sathi	S. Sathi	S. Sathi	S. Sathi	S. Sathi
89	E19ECR102	SWETHA.S	S. Sathi	S. Sathi	S. Sathi	S. Sathi	S. Sathi	S. Sathi	S. Sathi
90	E19ECR103	THAMARA KANNAN.E	T. Sathi	T. Sathi	T. Sathi	T. Sathi	T. Sathi	T. Sathi	T. Sathi
91	E19ECR104	THIRUNAVUKKARASU.J	T. Sathi	T. Sathi	T. Sathi	T. Sathi	T. Sathi	T. Sathi	T. Sathi
92	E19ECR105	UDHAYAKUMAR.R	U. Sathi	U. Sathi	U. Sathi	U. Sathi	U. Sathi	U. Sathi	U. Sathi
93	E19ECR106	UDHAYAMOORTHY.V	U. Sathi	U. Sathi	U. Sathi	U. Sathi	U. Sathi	U. Sathi	U. Sathi
94	E19ECR108	VEERASANJEEVI.M	V. Sathi	V. Sathi	V. Sathi	V. Sathi	V. Sathi	V. Sathi	V. Sathi
95	E19ECR109	VENUPRAKASH.K	V. Sathi	V. Sathi	V. Sathi	V. Sathi	V. Sathi	V. Sathi	V. Sathi
96	E19ECR110	VIGNESH.R	V. Sathi	V. Sathi	V. Sathi	V. Sathi	V. Sathi	V. Sathi	V. Sathi
97	E19ECR111	VIJAYALAKSHMI.M	V. Sathi	V. Sathi	V. Sathi	V. Sathi	V. Sathi	V. Sathi	V. Sathi
98	E19ECR113	VINODHINI.V	V. Sathi	V. Sathi	V. Sathi	V. Sathi	V. Sathi	V. Sathi	V. Sathi
99	E19ECR114	YOGAPRIYA.K	Y. Sathi	Y. Sathi	Y. Sathi	Y. Sathi	Y. Sathi	Y. Sathi	Y. Sathi
100	E19ECR115	YOCASHWARI.P.M	Y. Sathi	Y. Sathi	Y. Sathi	Y. Sathi	Y. Sathi	Y. Sathi	Y. Sathi
101	E19ECR116	YOHESH.M	Y. Sathi	Y. Sathi	Y. Sathi	Y. Sathi	Y. Sathi	Y. Sathi	Y. Sathi
102	E19ECL301	AKASH.K	K. Anush	K. Anush	K. Anush	K. Anush	K. Anush	K. Anush	K. Anush
103	E19ECL303	HARIHARAN M.S	H. Anush	H. Anush	H. Anush	H. Anush	H. Anush	H. Anush	H. Anush
104	E19ECL304	MUFEED S	M. Anush	M. Anush	M. Anush	M. Anush	M. Anush	M. Anush	M. Anush
105	E19ECL305	RAJESH S	R. Anush	R. Anush	R. Anush	R. Anush	R. Anush	R. Anush	R. Anush
106	E19ECL306	RAM GOPAL M	R. Anush	R. Anush	R. Anush	R. Anush	R. Anush	R. Anush	R. Anush
107	E19ECL307	SIVAKUMAR S	S. Anush	S. Anush	S. Anush	S. Anush	S. Anush	S. Anush	S. Anush
108	E19ECL308	VIJAY KUMAR S	V. Anush	V. Anush	V. Anush	V. Anush	V. Anush	V. Anush	V. Anush
109	E19ECL309	RANJITH.S	R. Anush	R. Anush	R. Anush	R. Anush	R. Anush	R. Anush	R. Anush
110	E19ECL310	RAKESH.R	R. Anush	R. Anush	R. Anush	R. Anush	R. Anush	R. Anush	R. Anush
111	E19ECL311	RENGARAJAN A	R. Anush	R. Anush	R. Anush	R. Anush	R. Anush	R. Anush	R. Anush
112	E19ECL312	VARADHARAJAN A	V. Anush	V. Anush	V. Anush	V. Anush	V. Anush	V. Anush	V. Anush

[Signature]
Course Coordinator

ATTESTED

Dr. S. RAMABALAN, M.E., Ph.D.,
PRINCIPAL

E.G.S. Pillay Engineering College,
Thethi, Nagere - 611 002.
Nagapattinam (Dt) Tamil Nadu.

[Signature]
HOD/CE



**E.G.S. PILLAY ENGINEERING COLLEGE, NAGAPATTINAM
(AUTONOMOUS)**

Department of Electronics and Communication Engineering

(Accredited by NAAC with 'A' grade || Recognized by DSIR || Recognized by UGC 2(f) & 12 (B))||Provisional Accreditation in NBA for EEE, CSE and Mechanical || Approved by AICTE, New Delhi & Affiliated to Anna University, Chennai)

**Value Added Course on
"Basics of Python Programming"**

Name: *Naveen. S*

Reg.No: *E19ECR063*

Dear Student,

You are required to give your feedback on the following aspects. Please tick in the respective column.

S.No	Criteria	Rating				
		Excellent	Very good	Good	Fair	Satisfactory
1	Course content		✓			
2	Skill development	✓				
3	Motivation	✓				
4	Regularity and punctuality of teacher		✓			
5	Coverage of syllabus		✓			
6	Interaction	✓				
7	Individual attention	✓				
8	Outcome		✓			
9	Other suggestions	✓				

ATTESTED

**Dr. S. RAMABALAN, M.E., Ph.D.,
PRINCIPAL
E.G.S. Pillay Engineering College,
Thethi, Nagore - 611 002.
Nagapattinam (Dt) Tamil Nadu.**



**E.G.S. PILLAY ENGINEERING COLLEGE, NAGAPATTINAM
(AUTONOMOUS)**

Department of Electronics and Communication Engineering

(Accredited by NAAC with 'A' grade || Recognized by DSIR || Recognized by UGC 2(f) & 12 (B)||Provisional Accreditation in NBA for EEE, CSE and Mechanical || Approved by AICTE, New Delhi & Affiliated to Anna University, Chennai)

**Value Added Course on
"Basics of Python Programming"**

Name: *Naveen. S*

Reg.No: *E19ECR063*

Dear Student,

You are required to give your feedback on the following aspects. Please tick in the respective column.

S.No	Criteria	Rating				
		Excellent	Very good	Good	Fair	Satisfactory
1	Course content		✓			
2	Skill development	✓				
3	Motivation	✓				
4	Regularity and punctuality of teacher		✓			
5	Coverage of syllabus		✓			
6	Interaction	✓				
7	Individual attention	✓				
8	Outcome		✓			
9	Other suggestions	✓				

ATTESTED

[Signature]
**Dr. S. RAMABALAN, M.E., Ph.D.,
PRINCIPAL**
E.G.S. Pillay Engineering College,
Thethi, Nagore - 611 002.
Nagapattinam (Dt) Tamil Nadu.



**E.G.S. PILLAY ENGINEERING COLLEGE, NAGAPATTINAM
(AUTONOMOUS)**

Department of Electronics and Communication Engineering

(Accredited by NAAC with 'A' grade || Recognized by DSIR || Recognized by UGC 2(f) & 12 (B)||Provisional Accreditation in NBA for EEE, CSE and Mechanical || Approved by AICTE, New Delhi & Affiliated to Anna University, Chennai)

**Value Added Course on
"Basics of Python Programming"**

Name: E19ECR090

Reg.No: S. Sindhya.

Dear Student,

You are required to give your feedback on the following aspects. Please tick in the respective column.

S.No	Criteria	Rating				
		Excellent	Very good	Good	Fair	Satisfactory
1	Course content	✓				
2	Skill development		✓			
3	Motivation		✓			
4	Regularity and punctuality of teacher			✓		
5	Coverage of syllabus		✓			
6	Interaction		✓	✓		
7	Individual attention			✓		
8	Outcome		✓			
9	Other suggestions			✓		

ATTESTED

**Dr. S. RAMABALAN, M.E., Ph.D.,
PRINCIPAL**
E.G.S. Pillay Engineering College,
Thetri, Nagore - 611 002.
Nagapattinam (Dt) Tamil Nadu.



**E.G.S. PILLAY ENGINEERING COLLEGE, NAGAPATTINAM
(AUTONOMOUS)**

Department of Electronics and Communication Engineering

(Accredited by NAAC with 'A' grade || Recognized by DSIR || Recognized by UGC 2(f) & 12 (B)||Provisional Accreditation in NBA for EEE, CSE and Mechanical || Approved by AICTE, New Delhi & Affiliated to Anna University, Chennai)

Value Added Course on “Basics of Python Programming”

Photos



ATTESTED

**Dr. S. RAMABALAN, M.E., Ph.D.,
PRINCIPAL
E.G.S. Pillay Engineering College,
Thetli, Nagore - 611 002,
Nagapattinam (Dt) Tamil Nadu.**

E.G.S.PILLAY ENGINEERING COLLEGE
(AUTONOMOUS, Accredited by NBA, NAAC, Affiliated to Anna
University, Approved by AICTE, New Delhi)

CERTIFICATE OF PARTICIPATION

This certificate is awarded to

S.Kamalesh III ECE

For her/his active and significant participation
In the Five-day Value added Course on Basics of Python Programming.
18.10.2021 to 22.10.2021

ATTESTED



Dr. S. RAMABALAN, M.E., Ph.D.,
PRINCIPAL

Pillay Engineering College,
Nethi Nagore - 611 002.
Narasimharajam (Dt) Tamil Nadu.

Course Coordinator 1
Course Coordinator 2

HOD/ECE



EGS PILLAY



Engineering College

Autonomous

Old Nagore Road, Nagapattinam-611 002, Tamilnadu

Affiliated to Anna University | Approved by AICTE | Accredited by - NBA & NAAC 'A' Grade | Recognised by UGC 2(f) & 12(B) | An ISO 9001:2015 Certified Institution

Counselling Code : 3806

+91-4365-251112/14 | principal@egspec.org/enquires@egspec.org

Department of Electronics and Communication Engineering

(Accredited by NBA)

THE ROLE OF ELECTRONICS IN AEROSPACE SYSTEMS

Date: 03/03/2022

Time: 3.00 PM – 4.30PM

By

Dr.G.Anitha, M.tech, Ph.D,
Associate Professor,
Department of Aerospace Engineering,
Madras Institute of Technology,
Anna University , Chennai.

Convenor : Co-ordinators

(S.SENTHILKUMAR) AP/ECE
(M.SELVASUNTHARI) AP/ECE

(DR. B. PADMANABAN)
HOD/ECE



E.G.S. PILLAY ENGINEERING COLLEGE
(An Autonomous Institution, Affiliated to Anna University, Chennai)
Nagore Post, Nagapattinam – 611 002, Tamilnadu.
Department of Electronics and Communication Engineering

The Role of Electronics in Aerospace Systems

REPORT

Online Guest Lecture Programme in “The Role of Electronics in Aerospace Systems”, has been conducted in our E.G.S Pillay Engineering College, Nagapattinam, organized by Department of Electronics and Communication Engineering, E.G.S. Pillay Engineering College, Nagapattinam. The Programme was started on 03.03.2022 at 3 pm in online mode.

The one of the co-ordinator **S.Senthil kumar, AP/ECE**, started this course with his welcome address. Head of the department **Dr.B.Padmanaban** gave the keynote address. Our esteemed Principal **Dr.S.Ramabalan** presented the inaugural address and finally Our chief Guest **Dr.G.Anitha, M.tech, Ph.D, Associate Professor, Department of Aerospace Engineering, Madras Institute of Technology, Anna University , Chennai** has explicated about Success full Interview skills needed for Jobs in Electronics and communication sectors, job Market expectations.

Finally, Programme came to a close, with the summary of the whole programme was given by **S.Senthil kumar, AP/ECE**, Coordinator, and Co-Coordinator **M.Selvasunthari AP/ECE**, proposed vote of thanks.

Coordinators
(Mr. S.Senthil kumar)
(Mrs. M.Selvasunthari)

ATTESTED

Dr. S. RAMABALAN, M.E., Ph.D.,
PRINCIPAL
E.G.S. Pillay Engineering College,
Thethi, Nagore - 611 002.
Nagapattinam (Dt) Tamil Nadu.

HOD
(Dr. B. Padmanaban)

Dr. B. PADMANABAN, M.E., Ph.D.
HEAD OF THE DEPARTMENT
DEPARTMENT OF ELECTRONICS AND
COMMUNICATION ENGINEERING,
E.G.S. PILLAY ENGINEERING COLLEGE,
NAGAPATTINAM - 611 002.

26.02.2022

From

S.Senthilkumar, AP,
M.Selvasunthari, AP,
Department of ECE,
E.G.S. Pillay Engineering College,
Nagapattinam.

To

The Principal,
E.G.S. Pillay Engineering College,
Nagapattinam.



Respected Sir,

Sub: Requisition to conduct online Lecture- Reg.

We planned to conduct Value added course on “The Role of Electronics in Aerospace Systems” for final ECE students dated on 03.03.2022. So, we request you to give the permission for this.

Thanking you,

Your's Faithfully



(S.Senthilkumar)



(M.Selvasunthari)

ATTESTED

Dr. S. RAMABALAN, M.E., Ph.D.,
PRINCIPAL
E.G.S. Pillay Engineering College,
Thethi, Nagore - 611 002.
Nagapattinam (Dt) Tamil Nadu.

Date: 26.02.2022

Place: EGSPEC, Nagapattinam

26.02.2022

From

S.Senthilkumar, AP,
M.Selvasunthari, AP,
Department of ECE,
E.G.S. Pillay Engineering College,
Nagapattinam.

To

The Principal,
E.G.S. Pillay Engineering College,
Nagapattinam.

BU
26/2/22

Respected Sir,

Sub: Requisition for Budget to conduct online lecture– Reg.

We planned to conduct Value added course on “**The Role of Electronics in Aerospace Systems**” for final ECE students dated on 03.03.2022. Approximation budget for this seminar is enclosed with this letter. We request you to kindly do the needful

Thanking you,

Your's Faithfully



(S.Senthilkumar)

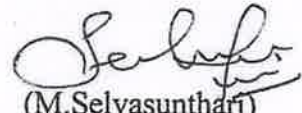

(M.Selvasunthari)

ATTESTED

Dr. S. RAMABALAN, M.E., Ph.D.,
PRINCIPAL
E.G.S. Pillay Engineering College,
Thethi, Nagore - 611 002.
Nagapattinam (Dt) Tamil Nadu.

Date: 26.02.2022

Place: EGSPEC, Nagapattinam.



EGS PILLAY



Engineering College

Autonomous

Old Nagore Road, Nagapattinam-611 002, Tamilnadu

Affiliated to Anna University | Approved by AICTE | Accredited by - NBA & NAAC 'A' Grade | Recognised by UGC 2(f) & 12(B) | An ISO 9001:2016 Certified Institution

Counselling Code : 3806

+91-4365-251112/14 | principal@egspec.org/enquires@egspec.org

Value added course

on

THE ROLE OF ELECTRONICS IN AEROSPACE SYSTEMS

(03.03.2022)

ORGANIZED BY

Department of Electronics and Communication Engineering

Date: 26.02.2022

BUDGET REQUIREMENT

S.No	Particulars	Amount Required (In Rs.)
01	Resource person honorarium	5,000/-
TOTAL		5,000/-

Coordinators

(S.Senthilkumar)
(M.Selvasunthari)

ATTESTED

Dr. S. RAMABALAN, M.E., Ph.D.,
PRINCIPAL
E.G.S. Pillay Engineering College,
Thethi, Nagore - 611 002,
Nagapattinam, (09) Tamil Nadu.

HOD

Dr. B. P. (Dr. B. Padmanaban) M.E., Ph.D.
HEAD OF THE DEPARTMENT
DEPARTMENT OF ELECTRONICS AND
COMMUNICATION ENGINEERING
E.G.S. PILLAY ENGINEERING COLLEGE,
NAGAPATTINAM - 611 002.

26.02.2022

From

Dr. B. Padmanaban,
Head of the department,
Department of ECE,
E.G.S. Pillay Engineering College,
Nagapattinam.

To

Dr.G.Anitha, M.tech, Ph.D,
Associate Professor,
Department of Aerospace Engineering,
Madras Institute of Technology,
Anna University , Chennai.

Respected Madam ,

Sub: Requisition to be an resource person and take session on importance of electronics in aerospace engineering – Reg.

Respected Sir,

I am very glad to share that, we are going to organize value added course on "The Role of Electronics in Aerospace Systems " which is scheduled on 03.03.2022 in online mode.In connection with this, it will be a great pleasure for us to request to be resource person and take session in internet of things .

Thanking you,

Your's Faithfully

(Dr. B. Padmanaban)

Place: EGSPEC, Nagapattinam

ATTESTED

DR. S. RAMABALAN, M.E., Ph.D.,
PRINCIPAL
E.G.S. Pillay Engineering College,
Thethi, Nagore - 611 002.
Nagapattinam (Dt) Tamil Nadu.

DR. B. PADMANABAN, M.E., Ph.D.,
HEAD OF THE DEPARTMENT
DEPARTMENT OF ELECTRONICS AND
COMMUNICATION ENGINEERING
E.G.S. PILLAY ENGINEERING COLLEGE,
NAGAPATTINAM - 611 002.

28.02.2022

From

Dr.G.Anitha, M.tech, Ph.D,
Associate Professor,
Department of Aerospace Engineering,
Madras Institute of Technology,
Anna University , Chennai.

To

Dr. B. Padmanaban,
Head of the department,
Department of ECE,
E.G.S. Pillay Engineering College,
Nagapattinam

Respected Sir,

Sub: Acceptance of resource person - **Guest Lecture – Reg.**

Respected Sir,

I am very happy to see your letter about to deliver a value added course on “**The Role of Electronics in Aerospace Systems**” as a resource person to your students. I would like to take this session . From this letter I confirm my present on 03.03.2022 on your college.

Thanking you,

Your's Faithfully

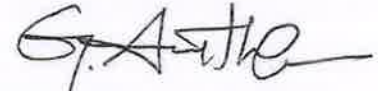

(Dr.G.Anitha, M.tech, Ph.d.)

ATTESTED

Dr. S. RAMABALAN, M.E., Ph.D.,
PRINCIPAL
E.G.S. Pillay Engineering College,
Thethi, Nagore - 611 002.
Nagapattinam (Dt) Tamil Nadu.

Date: 28.02.2022

Place: Chennai.

	<p>E.G.S. PILLAY ENGINEERING COLLEGE (An Autonomous Institution, Affiliated to Anna University, Chennai) Nagore Post, Nagapattinam – 611 002, Tamilnadu. Department of Electronics and Communication Engineering</p>
---	---

ECE/2021/ODD/CIRCULAR-07

DEPARTMENT CIRCULAR DATED

To enhance the practical Skills to face Interview and Some Needed abilities of our ECE students, We are going to conduct the value added course " **The Role of Electronics in Aerospace Systems** " program on 03.03.2022.

OBJECTIVE

An effort to create awareness on Importance of electronics in AEROSPACE. To enhance the practical Skills to face Interview and Some Needed abilities.

DAY	Participants	EVENT	RESOURCE PERSON
03.03.2022	IV ECE Students	<ul style="list-style-type: none"> • Practical Video of Working Environment. • IC fabrication and issues • Interview Skills and Knowledges • Some Important Electronics basics 	Dr.G.Anitha,M.tech, Ph.D, Associate Professor, Department of Aerospace Engineering, Madras Institute of Technology, Anna University , Chennai.

 Program Co-ordinators











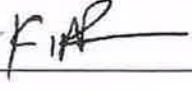
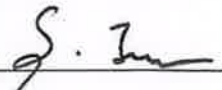

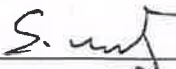
(S.Senthilkumar)
(M.Selvasunthari)

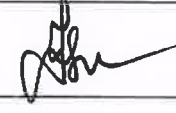

 HOD/ECE

(Dr. B. Padmanaban)
Dr. B. PADMANABAN, M.E., Ph.D.,
 HEAD OF THE DEPARTMENT
 DEPARTMENT OF ELECTRONICS AND
 COMMUNICATION ENGINEERING
 E.G.S. PILLAY ENGINEERING COLLEGE,
 NAGAPATTINAM - 611 002.

ATTESTED

Dr. S. RAMABALAN, M.E., Ph.D.,
 PRINCIPAL
 E.G.S. Pillay Engineering College,
 Thethi, Nagore - 611 002.
 Nagapattinam (Dt) Tamil Nadu.

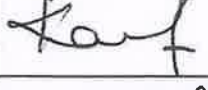
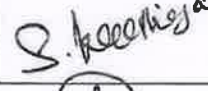
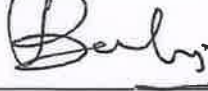
Faculty	Signature	Faculty	Signature
Mr.K.Parthasarathi		Mr.S.JimHawkinson	
Mrs.R.S.Kotteshwari		Mr.S.Senthilkumar	
Mrs.S.Chitra		Mr.T.Senthilkumar	
Mrs.V.Elavarasi		Ms.D.Muthulakshmi	
Mr.D.Devarajan		Ms.S.Dhanalakshmi	
Mr.M.Nuthal Srinivasan		Ms.S.Aadhirai	
Mr.M.Irshad Ahamed			
Mr.L.Ramachandran		--	--

Laboratory Technician	Signature
Mr.K.Raju	
Mr.V.Karthikeyan	
Mrs.S.Keerthiga	
Mr.V.G.Sudharasana Baalajee	
Mr.B.Nirmal Dev	

ATTESTED

Dr. S. RAMABALAN, M.E., Ph.D.,
PRINCIPAL
E.G.S. Pillay Engineering College,
Thethi, Nagore - 611 002.
Nagapattinam (Dt) Tamil Nadu.



EGS PILLAY



Engineering College

Autonomous

Old Nagore Road, Nagapattinam-611 002, Tamilnadu

Affiliated to Anna University | Approved by AICTE | Accredited by - NBA & NAAC 'A' Grade | Recognised by UGC 2(f) & 12(B) | An ISO 9001:2015 Certified Institution

Counselling Code : 3806

+91-4365-251112/14 | principal@egspec.org/enquires@egspec.org

Value added course

on

THE ROLE OF ELECTRONICS IN AEROSPACE SYSTEMS

(03.03.2022)

ORGANIZED BY

Department of Electronics and Communication Engineering

COMMITTEE LIST

Sl. No	Name of the Committee	Committee Representative	Responsibilities
1	Overall Program Coordination	S.Senthilkumar M.Selvasundary	Invitation, Brochure, Report Preparation, Programme schedule and Overall Control
2	Comparing	K.K.Shandhosh shree S.Jim Hawkinson	Comparing for Inauguration and Valediction, Chief Guest honour.
3	PRO	M.Nuthalsrinivasan, C.Mathuvasesan	Photo Session & Communication

Coordinators
(S.Senthilkumar)
(M.Selvasunthari)

HoD
(Dr. B. Padmanaban)

ATTESTED

Dr. S. RAMABALAN, M.E., Ph.D.,
PRINCIPAL

E.G.S. Pillay Engineering College,
Thethi, Nagore - 611 002,
Nagapattinam (Dt) Tamil Nadu.

Dr. B. PADMANABAN, M.E., Ph.D.,
HEAD OF THE DEPARTMENT
DEPARTMENT OF ELECTRONICS AND
COMMUNICATION ENGINEERING,
E.G.S. PILLAY ENGINEERING COLLEGE,
NAGAPATTINAM - 611 002.



EGS PILLAY



Engineering College

Autonomous

Old Nagore Road, Nagapattinam-611 002, Tamilnadu

Affiliated to Anna University | Approved by AICTE | Accredited by - NBA & NAAC 'A' Grade | Recognised by UGC 2(B) & 12(B) | An ISO 9001:2015 Certified Institution

Counselling Code : 3806

+91-4365-251112/14 | principal@egspec.org/enquires@egspec.org

Value added course

on

THE ROLE OF ELECTRONICS IN AEROSPACE SYSTEMS

(03.03.2022)

ORGANIZED BY

Department of Electronics and Communication Engineering

PARTICIPATION NAME LIST

S. No.	Register Number	Name of the Student	COLLEGE NAME
1	E18ECR001	AARTHI B	E.G.S PILLAY ENGINEERING COLLEGE
2	E18ECR002	ABARNA M	E.G.S PILLAY ENGINEERING COLLEGE
3	E18ECR003	ABINESH M	E.G.S PILLAY ENGINEERING COLLEGE
4	E18ECR004	ABIRAMI R A	E.G.S PILLAY ENGINEERING COLLEGE
5	E18ECR005	AKASH S	E.G.S PILLAY ENGINEERING COLLEGE
6	E18ECR006	AMARESH R	E.G.S PILLAY ENGINEERING COLLEGE
7	E18ECR007	ARTHI S	E.G.S PILLAY ENGINEERING COLLEGE
8	E18ECR008	ARUNKUMAR N	E.G.S PILLAY ENGINEERING COLLEGE
9	E18ECR009	ARUNYA A	E.G.S PILLAY ENGINEERING COLLEGE
10	E18ECR010	ATCHAYA S	E.G.S PILLAY ENGINEERING COLLEGE
11	E18ECR011	BADRUJJAMAN MS	E.G.S PILLAY ENGINEERING COLLEGE
12	E18ECR012	BOOPATHY P	E.G.S PILLAY ENGINEERING COLLEGE

ATTESTED

D.S. RAMABALAN M.E., Ph.D.
PRINCIPAL

E.G.S. Pillay Engineering College,

Thethi, Nagore - 611 002.

Nagapattinam (Dt) Tamil Nadu.

13	E18ECR013	CHANDRU M	E.G.S PILLAY ENGINEERING COLLEGE
14	E18ECR014	GNANAPRAKASAM S	E.G.S PILLAY ENGINEERING COLLEGE
15	E18ECR015	HARIHARAN K	E.G.S PILLAY ENGINEERING COLLEGE
16	E18ECR016	HARINI G	E.G.S PILLAY ENGINEERING COLLEGE
17	E18ECR017	HARISH V	E.G.S PILLAY ENGINEERING COLLEGE
18	E18ECR018	IYAPPAN A	E.G.S PILLAY ENGINEERING COLLEGE
19	E18ECR019	JANANI.G	E.G.S PILLAY ENGINEERING COLLEGE
20	E18ECR020	JESSIYA J	E.G.S PILLAY ENGINEERING COLLEGE
21	E18ECR021	KAMALRAJ.R	E.G.S PILLAY ENGINEERING COLLEGE
22	E18ECR022	KEERTHANA K	E.G.S PILLAY ENGINEERING COLLEGE
23	E18ECR023	LAVANYA A	E.G.S PILLAY ENGINEERING COLLEGE
24	E18ECR024	LAVANYA K	E.G.S PILLAY ENGINEERING COLLEGE
25	E18ECR025	LINGESHWARI V	E.G.S PILLAY ENGINEERING COLLEGE
26	E18ECR026	MANICKASARATHAM M	E.G.S PILLAY ENGINEERING COLLEGE
27	E18ECR027	MANIKANDAN S	E.G.S PILLAY ENGINEERING COLLEGE
28	E18ECR028	MANIRATHNAM A	E.G.S PILLAY ENGINEERING COLLEGE
29	E18ECR029	MARIYADOSS S	E.G.S PILLAY ENGINEERING COLLEGE
30	E18ECR030	MOHAMED SHAGUL HAMEED T	E.G.S PILLAY ENGINEERING COLLEGE
31	E18ECR031	MONIKA A	E.G.S PILLAY ENGINEERING COLLEGE
32	E18ECR032	MUGESH R	E.G.S PILLAY ENGINEERING COLLEGE
33	E18ECR033	NANTHINI R	E.G.S PILLAY ENGINEERING COLLEGE
34	E18ECR034	NIRAIMATHI V	E.G.S PILLAY ENGINEERING COLLEGE
35	E18ECR035	NIVASHINI R	E.G.S PILLAY ENGINEERING COLLEGE
36	E18ECR036	OVIYA R	E.G.S PILLAY ENGINEERING COLLEGE
37	E18ECR037	POONKOTHAI K	E.G.S PILLAY ENGINEERING COLLEGE
38	E18ECR038	PRADEEP T	E.G.S PILLAY ENGINEERING COLLEGE
39	E18ECR039	PRIYADHARSHINI B	E.G.S PILLAY ENGINEERING COLLEGE

ATTESTED

DR. SRINIVASAN
PRINCIPAL
E.G.S. Pillay Engineering College,
Thethi, Nagore - 611 002.
Nagapattinam (Dt) Tamil Nadu.

40	E18ECR040	RIFAYUDEEN N	E.G.S PILLAY ENGINEERING COLLEGE
41	E18ECR041	ROSHINI C	E.G.S PILLAY ENGINEERING COLLEGE
42	E18ECR042	SAAJIDHULLAH I	E.G.S PILLAY ENGINEERING COLLEGE
43	E18ECR043	SANTHOSH R	E.G.S PILLAY ENGINEERING COLLEGE
44	E18ECR044	SARABESHWARAN S	E.G.S PILLAY ENGINEERING COLLEGE
45	E18ECR045	SARANKUMAR L	E.G.S PILLAY ENGINEERING COLLEGE
46	E18ECR046	SEETHALAKSHMI L	E.G.S PILLAY ENGINEERING COLLEGE
47	E18ECR047	SELLAMUTHU M	E.G.S PILLAY ENGINEERING COLLEGE
48	E18ECR048	SHAFRIN BEEVI S	E.G.S PILLAY ENGINEERING COLLEGE
49	E18ECR049	SHALINI A	E.G.S PILLAY ENGINEERING COLLEGE
50	E18ECR050	SHALINI S	E.G.S PILLAY ENGINEERING COLLEGE
51	E18ECR051	SHANMUGARAJ T	E.G.S PILLAY ENGINEERING COLLEGE
52	E18ECR052	SIVANANTHAMOORTHIP	E.G.S PILLAY ENGINEERING COLLEGE
53	E18ECR053	SIVASAKTHIVEL G	E.G.S PILLAY ENGINEERING COLLEGE
54	E18ECR054	SIVASUKITHA S	E.G.S PILLAY ENGINEERING COLLEGE
55	E18ECR055	SUDHARSHAN A	E.G.S PILLAY ENGINEERING COLLEGE
56	E18ECR056	SURESHRAJAN R	E.G.S PILLAY ENGINEERING COLLEGE
57	E18ECR057	SWATHIYA M	E.G.S PILLAY ENGINEERING COLLEGE
58	E18ECR058	THIYAKESAN G	E.G.S PILLAY ENGINEERING COLLEGE
59	E18ECR059	VASUNDARAA S	E.G.S PILLAY ENGINEERING COLLEGE
60	E18ECR060	VIJAYAKUMAR B	E.G.S PILLAY ENGINEERING COLLEGE
61	E18ECR061	VIJAYAKUMAR K	E.G.S PILLAY ENGINEERING COLLEGE
62	E18ECR062	VINOTHINI G	E.G.S PILLAY ENGINEERING COLLEGE
63	E18ECL301	ABINASH U	E.G.S PILLAY ENGINEERING COLLEGE
64	E18ECL302	ABINAYA T	E.G.S PILLAY ENGINEERING COLLEGE
65	E18ECL303	ABIRAMI K	E.G.S PILLAY ENGINEERING COLLEGE
66	E18ECL304	AHILAR	E.G.S PILLAY ENGINEERING COLLEGE

ATTESTED

DR. S. RAMABALAN, M.E., Ph.D.
PRINCIPAL
E.G.S. Pillay Engineering College,
Thethi, Nagore - 611 002.
Nagapattinam (Dt) Tamil Nadu.



EGS PILLAY



Engineering College

Autonomous

Old Nagore Road, Nagapattinam-611 002, Tamilnadu

Affiliated to Anna University | Approved by AICTE | Accredited by - NBA & NAAC 'A' Grade | Recognised by UGC 2(f) & 12(B) | An ISO 9001:2015 Certified Institution

Counselling Code : 3806

+91-4365-251112/14 | principal@egspeg.org/enquiries@egspeg.org

Value added course

on

THE ROLE OF ELECTRONICS IN AEROSPACE SYSTEMS

(03.03.2022)

ORGANIZED BY

Department of Electronics and Communication Engineering

Date: 03.03.2022

EXPENDITURE DETAILS

S.NO	PARTICULARS	AMOUNT SPENT (in Rs.)
01	Resource person honorarium	5,000/-
	TOTAL	5,000/-

Coordinators

(S.Senthilkumar)
(M.Selvasunthari)

HOD

(Dr. B. Padmanaban)

Dr. B. PADMANABAN, M.E., Ph.D.
HEAD OF THE DEPARTMENT
DEPARTMENT OF ELECTRONICS AND
COMMUNICATION ENGINEERING
E.G.S. PILLAY ENGINEERING COLLEGE,
NAGAPATTINAM - 611 002.

ATTESTED

Dr. S. RAMABALAN, M.E., Ph.D.
PRINCIPAL

E.G.S. Pillay Engineering College,
Thethi, Nagore - 611 002.
Nagapattinam (Dt) Tamil Nadu.

67	E18ECL305	ANANDHARAJ T	E.G.S PILLAY ENGINEERING COLLEGE
68	E18ECL306	ARAVINDH E	E.G.S PILLAY ENGINEERING COLLEGE
69	E18ECL307	KARAN B	E.G.S PILLAY ENGINEERING COLLEGE
70	E18ECL308	KARTHIKA P	E.G.S PILLAY ENGINEERING COLLEGE
71	E18ECL309	MUTHU R	E.G.S PILLAY ENGINEERING COLLEGE
72	E18ECL310	NIVETHA V	E.G.S PILLAY ENGINEERING COLLEGE
73	E18ECL311	PREMKUMAR N	E.G.S PILLAY ENGINEERING COLLEGE
74	E18ECL312	RAJESH T	E.G.S PILLAY ENGINEERING COLLEGE
75	E18ECL313	RAJKUMAR S	E.G.S PILLAY ENGINEERING COLLEGE
76	E18ECL314	RAMESH S	E.G.S PILLAY ENGINEERING COLLEGE
77	E18ECL315	REVATHI K	E.G.S PILLAY ENGINEERING COLLEGE
78	E18ECL316	SAKTHIVEL S	E.G.S PILLAY ENGINEERING COLLEGE
79	E18ECL317	SAMUEL P	E.G.S PILLAY ENGINEERING COLLEGE
80	E18ECL318	SELVAGANAPATHY S	E.G.S PILLAY ENGINEERING COLLEGE
81	E18ECL319	SIVASHANMUGAM R	E.G.S PILLAY ENGINEERING COLLEGE
82	E18ECL320	SYED ALI S	E.G.S PILLAY ENGINEERING COLLEGE
83	E18ECL321	THARIQ S	E.G.S PILLAY ENGINEERING COLLEGE

 Coordinators
 (S.Senthilkumar)
 (M.Selvasunthari)

ATTESTED

 Dr. S. RAMABALAN, M.E., Ph.D.,
 PRINCIPAL
 E.G.S. Pillay Engineering College,
 Thethi, Nagore - 611 002.
 Nagapattinam (Dt) Tamil Nadu.

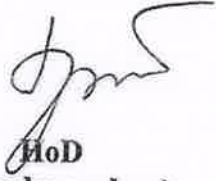
 (Dr. B. Padmanaban)
 Dr. B. PADMANABAN, M.E., Ph.D.,
 HEAD OF THE DEPARTMENT
 DEPARTMENT OF ELECTRONICS AND
 COMMUNICATION ENGINEERING
 E.G.S. PILLAY ENGINEERING COLLEGE,
 NAGAPATTINAM - 611 002.



EGS PILLAY

Engineering College

Autonomous

Old Nagore Road, Nagapattinam-611 002, Tamilnadu

Affiliated to Anna University | Approved by AICTE | Accredited by - NBA & NAAC 'A' Grade | Recognised by UGC 2(f) & 12(B) | An ISO 9001:2015 Certified Institution

Counselling Code : 3806

+91-4365-251112/14 | principal@egspec.org/enquires@egspec.org



Value added course

on

THE ROLE OF ELECTRONICS IN AEROSPACE SYSTEMS

(03.03.2022)

ORGANIZED BY

Department of Electronics and Communication Engineering

Information from participants feedbacks are collectively listed below

1. The topic coverage and relevance of this seminar is very good. (Overall Rating 4)
2. The objective of the seminar is clearly defined. (Overall Rating 4)
3. The quality of delivered content is very good. (Overall Rating 4)
4. Seminar material is useful. (Overall Rating 3)

Coordinators

((S.Senthilkumar)

(M.Selvasunthari)

ATTESTED

Dr. S. RAMABALAN, M.E., Ph.D.,
PRINCIPAL

E.G.S. Pillay Engineering College,
Thethi, Nagore - 611 002,
Nagapattinam (Dt) Tamil Nadu,

HoD

Dr. B. PADMANABAN, M.E., Ph.D.,
HEAD OF THE DEPARTMENT
DEPARTMENT OF ELECTRONICS AND
COMMUNICATIONS ENGINEERING
E.G.S. PILLAY ENGINEERING COLLEGE,
Thethi, Nagore - 611 002.

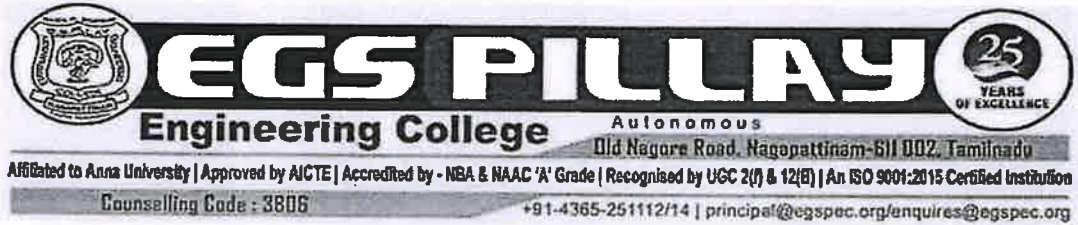

Value added course

on

**THE ROLE OF ELECTRONICS IN AEROSPACE SYSTEMS
(03.03.2022)**

ORGANIZED BY

Department of Electronics and Communication Engineering

Recommendation for further actions based on feedback and attainment calculation

1. As we got very good feedback in topic coverage and relevance of this seminar, further more we can arrange more relevant and current trend topics seminar
2. Since Objective of the seminar is clearly defined and quality of delivered content is very good, we will arrange more seminars with same resource person
3. Seminar material is useful but need more clear and in depth concepts we will make more easy materials for understanding and future reference
4. Due to reach of Expected level in program, we will keep arranging similar programs
5. From the students feedback of welcoming, this programme can be conducted for upcoming batch students.

Coordinators
(S.Senthilkumar)
(M.Selvasunthari)

ATTESTED

Dr. S. RAMABALAN, M.E., Ph.D.
PRINCIPAL
E.G.S. Pillay Engineering College,
Thethi, Nagore - 611 002,
Nagapattinam (Dt) Tamil Nadu.

HoD
(Dr. B. Padmanaban)

Dr. B. PADMANABAN, M.E., Ph.D.
HEAD OF THE DEPARTMENT
DEPARTMENT OF ELECTRONICS AND
COMMUNICATION ENGINEERING

[Home](#) | [About](#) | [Contact](#) | [Privacy Policy](#) | [Terms of Service](#) | [Feedback](#)

[MATLAB Engineering Project Ideas](#)

[Overview](#) | [Teach](#) | [Learn](#) | [Research](#) | [Student Programs](#)

Featured Project Ideas

Review this sampling of research and design MATLAB project ideas and be inspired to solve challenging industry problems. See the complete project list and find out how to get started.

Satellite Collision Avoidance

Model satellites in low Earth orbit (LEO) to identify conjunctions and prevent collisions with space debris while maintaining orbital requirements.

Impact
 Contribute to the success of satellite mega-constellations and improve the safety of the LEO environment.

Expertise Gained
 Autonomous Vehicles, Aerospace, Satellites, Control, Modeling and Simulation

Download: [satellite_collision_avoidance.pdf](#)

Meet.google.com is sharing your screen. [Stop sharing](#) [Hide](#) [View all](#)

Type here to search

15:17 17/01/2021

Nuthal Srinivasan is presenting



KO...

Vi...

Ad...

In call



K.K.Shandhosh Shree ECE (You)



Nuthal Srinivasan M

Meeting host



Nuthal Srinivasan M

Meeting host



Nuthal Srinivasan ...

Meeting host



Adarsh Chaunal



Deepa R ECE



HOD ECE



IRSHAD AHAMED....



KOTEESWARI.RS ECE



MATHUVANESAN.C...



Merged Doc ID - certifica Merged Doc URL - certifi Link to merged Doc - cer Document Merge Status

1qUUDsNzJyFQzmV6gCg <https://drive.google.com/file/d/1qUUDsNzJyFQzmV6gCg/view> Mr. R. Muthu CERTIFICATE Document successfully cre

1pSpQatU0OER9QG5Q5Z <https://drive.google.com/file/d/1pSpQatU0OER9QG5Q5Z/view> Mr. Sugumar V R CERTIFICATE Document successfully cre

109WtrymUXHhjbN0hR35 <https://drive.google.com/file/d/109WtrymUXHhjbN0hR35/view> Mrs.K.Usha CERTIFICATE Document successfully cre

16CzA3KuyOEhspKYITs3 <https://drive.google.com/file/d/16CzA3KuyOEhspKYITs3/view> Saravana G CERTIFICATE Document successfully cre

1YAd34sFvkmF3vyGpSRj <https://drive.google.com/file/d/1YAd34sFvkmF3vyGpSRj/view> Mrs.s.chitra CERTIFICATE Document successfully cre

1v2MsMNo_do0Oln8peRd https://drive.google.com/file/d/1v2MsMNo_do0Oln8peRd/view Keerthika v CERTIFICATE Document successfully cre

1HYEoohCKiyLz51cZXdmj <https://drive.google.com/file/d/1HYEoohCKiyLz51cZXdmj/view> Bhuvaneswari.G CERTIFICATE Document successfully cre

1HBtvbhZAB3IEea9PKNvt <https://drive.google.com/file/d/1HBtvbhZAB3IEea9PKNvt/view> V.VINODHINI CERTIFICATE Document successfully cre

1ReWgU_exG_6xJC7Z_4t https://drive.google.com/file/d/1ReWgU_exG_6xJC7Z_4t/view Mr. R.Amaresh CERTIFICATE Document successfully cre

1XJysROemHTgbfQ7Ml6c <https://drive.google.com/file/d/1XJysROemHTgbfQ7Ml6c/view> CERTIFICATE Document successfully cre

117oIDVp5CeSlwAdAN2h <https://drive.google.com/file/d/117oIDVp5CeSlwAdAN2h/view> Mr. N. ARUNKUMAR CERTIFICATE Document successfully cre

1BzIXqg6xk-5WQ5fx-ioCci <https://drive.google.com/file/d/1BzIXqg6xk-5WQ5fx-ioCci/view> Mr SELVAGANAPATHY.S Document successfully cre

1xJxfRMBxzo0IPDS3Frqr <https://drive.google.com/file/d/1xJxfRMBxzo0IPDS3Frqr/view> Dr.R.A.ABIRAMI CERTIFICATE Document successfully cre

1foBpkoUUxoS_XQadYf3t https://drive.google.com/file/d/1foBpkoUUxoS_XQadYf3t/view KEEERTHIKA CERTIFICATE Document successfully cre

1rR_TZq3YOzUV-C_1eZ5 https://drive.google.com/file/d/1rR_TZq3YOzUV-C_1eZ5/view Prof.S.Jim Hawkinson CERTIFICATE Document successfully cre

1W_NT5bjR8lbNQtr9E-sB https://drive.google.com/file/d/1W_NT5bjR8lbNQtr9E-sB/view Mr.sivasakthivel.g CERTIFICATE Document successfully cre

1o8F15kTHdsZ8wblQovM3 <https://drive.google.com/file/d/1o8F15kTHdsZ8wblQovM3/view> Mr. R. Saijithram CERTIFICATE Document successfully cre

1qwCQdz0yHndDtGEkC20 <https://drive.google.com/file/d/1qwCQdz0yHndDtGEkC20/view> Ms.Reshma Sasidaran CERTIFICATE Document successfully cre

16mJV6YPXz_WaRp1IYA https://drive.google.com/file/d/16mJV6YPXz_WaRp1IYA/view Ms.Malarvizhi.A CERTIFICATE Document successfully cre

1yDMUxpsAO8CZZ1FEQz <https://drive.google.com/file/d/1yDMUxpsAO8CZZ1FEQz/view> Ms S. VASUNDARAA CERTIFICATE Document successfully cre

13pQghyKNjpkf4uar2wt <https://drive.google.com/file/d/13pQghyKNjpkf4uar2wt/view> Ms CERTIFICATE Document successfully cre

19O-Ff0x_aRLOsT4xV8B https://drive.google.com/file/d/19O-Ff0x_aRLOsT4xV8B/view Mr. SARABESHWARAN S CERTIFICATE Document successfully cre

1gO-oKkfaunQqwC2x0xc <https://drive.google.com/file/d/1gO-oKkfaunQqwC2x0xc/view> Mr. Akash s CERTIFICATE Document successfully cre

17TYghTMvS47pRTW07C <https://drive.google.com/file/d/17TYghTMvS47pRTW07C/view> Mr CERTIFICATE Document successfully cre

1bXHLexT66uFuOY5JnVF <https://drive.google.com/file/d/1bXHLexT66uFuOY5JnVF/view> Miss M. Jai Shree CERTIFICATE Document successfully cre

12ttExkjD1BL1laiZpCcAr <https://drive.google.com/file/d/12ttExkjD1BL1laiZpCcAr/view> SUBASH.S CERTIFICATE Document successfully cre

1sUtrUAIFCI_JoL11OwRqr https://drive.google.com/file/d/1sUtrUAIFCI_JoL11OwRqr/view Ms. Lavanya k CERTIFICATE Document successfully cre

1X4ZIdxUcWvgfATEzNgW <https://drive.google.com/file/d/1X4ZIdxUcWvgfATEzNgW/view> Ms. AARTHI. B CERTIFICATE Document successfully cre

1E98shR3B90Op2XqKu0C <https://drive.google.com/file/d/1E98shR3B90Op2XqKu0C/view> M.Abarna CERTIFICATE Document successfully cre

1yOv-TwU5jkBytLuflPi572 <https://drive.google.com/file/d/1yOv-TwU5jkBytLuflPi572/view> Mrs SEETHALAKSHMI CERTIFICATE Document successfully cre

1gdorfYzIoAZs-SePafa1N <https://drive.google.com/file/d/1gdorfYzIoAZs-SePafa1N/view> Mr.SAAJIDHULLAH I CERTIFICATE Document successfully cre

1pgS4TJ_3cxm3uKb2XOX https://drive.google.com/file/d/1pgS4TJ_3cxm3uKb2XOX/view Mr.SYED ALI S CERTIFICATE Document successfully cre

1K7oJ1XMhF7W5058UR6 <https://drive.google.com/file/d/1K7oJ1XMhF7W5058UR6/view> Mr A. Prakash CERTIFICATE Document successfully cre

1r7C22n-hDVP9yTc1zDHR <https://drive.google.com/file/d/1r7C22n-hDVP9yTc1zDHR/view> Dr. M. Irshad Ahamed CERTIFICATE Document successfully cre

1Xpn2IEREANLW9d4xktf <https://drive.google.com/file/d/1Xpn2IEREANLW9d4xktf/view> Mr.P.SIVANANTHAMOOR CERTIFICATE Document successfully cre

1AcIR-RR55i_0oe2-6H5ffg https://drive.google.com/file/d/1AcIR-RR55i_0oe2-6H5ffg/view Mr.SAAJIDHULLAH I CERTIFICATE Document successfully cre

1C3mlOhLzuO79CHds-Xs <https://drive.google.com/file/d/1C3mlOhLzuO79CHds-Xs/view> V.ABITHA CERTIFICATE Document successfully cre

1ObMBjB61fHiZg0tZrWG <https://drive.google.com/file/d/1ObMBjB61fHiZg0tZrWG/view> Mr.RIFAYUDEEN N CERTIFICATE Document successfully cre

1ydAH0bIGvn3YNX2OFT <https://drive.google.com/file/d/1ydAH0bIGvn3YNX2OFT/view> Mrs S.Malavika CERTIFICATE Document successfully cre

1VubY76RUljE4hQLaki10S <https://drive.google.com/file/d/1VubY76RUljE4hQLaki10S/view> Mr HARIRAMAPRASATH CERTIFICATE Document successfully cre

1arwAAq_kz4v9P7nzelept https://drive.google.com/file/d/1arwAAq_kz4v9P7nzelept/view Swetha A CERTIFICATE Document successfully cre

1MyeVE3QK9LF7keb8NYI <https://drive.google.com/file/d/1MyeVE3QK9LF7keb8NYI/view> Mr. Jaipoorna.S CERTIFICATE Document successfully cre

18pHvnWbgL-QDmaJyqCt <https://drive.google.com/file/d/18pHvnWbgL-QDmaJyqCt/view> Mr. S.SUBALAKSHMI CERTIFICATE Document successfully cre

Dr. S. RAMABALAN, M.E., Ph.D.
PRINCIPAL

E.G.S. Pillay Engineering College
Thattai, Nagore - 611 002.
Nagapattinam (Dt) Tamil Nadu.

13cwLw3L8gEQ9-edArUP: <https://drive.google.com/file/d/13cwLw3L8gEQ9-edArUP/view> Mr SHANMUGARAJ T CE Document successfully cre
1g0qZv0u8f5qjDx48dlykUl: <https://drive.google.com/file/d/1g0qZv0u8f5qjDx48dlykUl/view> A. Arunya CERTIFICATE Document successfully cre
1yNT2-FJePs802uyiGtj7M: <https://drive.google.com/file/d/1yNT2-FJePs802uyiGtj7M/view> K.kamalavashini CERTIFIC Document successfully cre
1ilcpjpXwrbL3j7CW69RTR: <https://drive.google.com/file/d/1ilcpjpXwrbL3j7CW69RTR/view> Mr. G Thiyakesan CERTIF Document successfully cre
1quDW8z5yjshOvBKVDG: <https://drive.google.com/file/d/1quDW8z5yjshOvBKVDG/view> K.Keerthana CERTIFICAT Document successfully cre
1zR9-4pvewJqFUyx5Hzdri: <https://drive.google.com/file/d/1zR9-4pvewJqFUyx5Hzdri/view> VIGNESHWARAN M J CE Document successfully cre
1Z12880CjtUp7r7WfUAQL: <https://drive.google.com/file/d/1Z12880CjtUp7r7WfUAQL/view> Mr. K. VIJAYAKUMAR CE Document successfully cre
1KwthwGDRv_T_6j1QQWl: https://drive.google.com/file/d/1KwthwGDRv_T_6j1QQWl/view Mr. IYAPPAN A CERTIFIC Document successfully cre
1reR6H3xNH1Loz9VEN_9: https://drive.google.com/file/d/1reR6H3xNH1Loz9VEN_9/view SURYA PRAKASH .B CEF Document successfully cre
12ikiIVKSJ0Hn1NBA_clsm: https://drive.google.com/file/d/12ikiIVKSJ0Hn1NBA_clsm/view Dr.S.M.Ramesh CERTIFIC Document successfully cre
1aKzMPQ0rY4ICQPK3vut: <https://drive.google.com/file/d/1aKzMPQ0rY4ICQPK3vut/view> Mr.Lokeswaran.S CERTIF Document successfully cre
1JSCX02tya3zvWi__cq5qi: https://drive.google.com/file/d/1JSCX02tya3zvWi__cq5qi/view Mr Mohamed Sameer B Cj Document successfully cre
1K3V2a7fP4W5cxgO_6Mv: https://drive.google.com/file/d/1K3V2a7fP4W5cxgO_6Mv/view E. NANTHAN CERTIFICA Document successfully cre
1bjeBoTZJWZ4aVUU80dz: <https://drive.google.com/file/d/1bjeBoTZJWZ4aVUU80dz/view> mr CERTIFICATE Document successfully cre
1a6SGKgWCDtwBHvJ_h1: https://drive.google.com/file/d/1a6SGKgWCDtwBHvJ_h1/view Mr. Boopathy CERTIFICA Document successfully cre
1WE5op78qjy9peMGUoljv: <https://drive.google.com/file/d/1WE5op78qjy9peMGUoljv/view> Mr RAMESH.S CERTIFIC Document successfully cre
1S113JCAj-ZHAz0PLa1-C: <https://drive.google.com/file/d/1S113JCAj-ZHAz0PLa1-C/view> Ms. ARTHI. S CERTIFICA Document successfully cre
1fzjxclle9jKtmEb_AQJpOl: https://drive.google.com/file/d/1fzjxclle9jKtmEb_AQJpOl/view Mr.S.SARAVANAN CERTI Document successfully cre
19WDJbV7dow79npXm98: <https://drive.google.com/file/d/19WDJbV7dow79npXm98/view> V.Subasri CERTIFICATE Document successfully cre
1AMU29xuXIBLzsY0LT7o: <https://drive.google.com/file/d/1AMU29xuXIBLzsY0LT7o/view> Ms.Atchaya CERTIFICATE Document successfully cre
1H29k1wNLO2i47RlxBFH: <https://drive.google.com/file/d/1H29k1wNLO2i47RlxBFH/view> Mr.R. UDHAYA KUMAR (Document successfully cre
1fKXgHJZwb8l4nxs0EvY: <https://drive.google.com/file/d/1fKXgHJZwb8l4nxs0EvY/view> Mr. JAYADEVAN N M CEF Document successfully cre
10zx_jKY3fL43BphWiu5xf: https://drive.google.com/file/d/10zx_jKY3fL43BphWiu5xf/view Mr. S. Senthilkumar CERT Document successfully cre
1wUPZNG-inT9LAJrYEuIC: <https://drive.google.com/file/d/1wUPZNG-inT9LAJrYEuIC/view> Mr.E. ASWATHAMAN CEF Document successfully cre
1-Rvffe9VTh-5W_v0OnlC: https://drive.google.com/file/d/1-Rvffe9VTh-5W_v0OnlC/view Mr.B.MAHENDRAN CERT Document successfully cre
1XZIZzBR4QUc8Vok7Vo: <https://drive.google.com/file/d/1XZIZzBR4QUc8Vok7Vo/view> PRIYADHARSHINI.B CER Document successfully cre
1YM97M3TyyppqGTBeVNo: <https://drive.google.com/file/d/1YM97M3TyyppqGTBeVNo/view> Mr. R. Muthu CERTIFICAT Document successfully cre
1hyLoMjhjlmUqlstswZ1LC: <https://drive.google.com/file/d/1hyLoMjhjlmUqlstswZ1LC/view> K MANIVANNAN CERTIF Document successfully cre
1Q7SKhd8xUaxzc-oGYEa: <https://drive.google.com/file/d/1Q7SKhd8xUaxzc-oGYEa/view> Ms.G.VINOTHINI CERTIF Document successfully cre
1Tw-T5EE-ODrZvtnvCRT: <https://drive.google.com/file/d/1Tw-T5EE-ODrZvtnvCRT/view> Mr V.sophia CERTIFICAT Document successfully cre
19FNrQkjbiofDp_KpdkcmI: https://drive.google.com/file/d/19FNrQkjbiofDp_KpdkcmI/view Ms.A.Abinaya CERTIFICA Document successfully cre
1VIExdOWTL_ErjB6yDLG: https://drive.google.com/file/d/1VIExdOWTL_ErjB6yDLG/view S.familiarufi CERTIFICATE Document successfully cre
18m0Ud7TnqIMU7XDZZJ: <https://drive.google.com/file/d/18m0Ud7TnqIMU7XDZZJ/view> Mr.SELLAMUTHU M CER Document successfully cre
1FFx-QtP3Cyue74VMejD: <https://drive.google.com/file/d/1FFx-QtP3Cyue74VMejD/view> Mr. Vijayakumar. B CERTI Document successfully cre
19jKKqhHnX8gibGI6-YCB: <https://drive.google.com/file/d/19jKKqhHnX8gibGI6-YCB/view> RAJESH T CERTIFICATE Document successfully cre
1Wup6WDEz7PQ36f7UKC: <https://drive.google.com/file/d/1Wup6WDEz7PQ36f7UKC/view> Ms.J.Suvedha CERTIFICA Document successfully cre
1JwBP9nezp9PjgKf8qKE: <https://drive.google.com/file/d/1JwBP9nezp9PjgKf8qKE/view> Mrs. V. ELAVARASI CEI Document successfully cre
1SSekTOBK20tutm7uhPs: <https://drive.google.com/file/d/1SSekTOBK20tutm7uhPs/view> ABINESH.M CERTIFICAT Document successfully cre
1xTsn3VjVVN_Ao3u_Atr1: https://drive.google.com/file/d/1xTsn3VjVVN_Ao3u_Atr1/view Mr S S VIKASH VIKNESH Document successfully cre
1ZNqPwWYy-bBCII4ZTi2u: <https://drive.google.com/file/d/1ZNqPwWYy-bBCII4ZTi2u/view> Kamalraj CERTIFICATE Document successfully cre
1L0qA-SM9_17WZ8w6ZD/: https://drive.google.com/file/d/1L0qA-SM9_17WZ8w6ZD/view Mrs.R.AHILA CERTIFICAT Document successfully cre
1uwJSDwO2TdMtOnjTkC: <https://drive.google.com/file/d/1uwJSDwO2TdMtOnjTkC/view> Mr.B. Ragu CERTIFICATE Document successfully cre
1F0LbkaJndwGqr1SeFOe: <https://drive.google.com/file/d/1F0LbkaJndwGqr1SeFOe/view> G.V. SHRICHANDRAN Document successfully cre
1ZZXdZx-8Zq8L6MxO4IbL: <https://drive.google.com/file/d/1ZZXdZx-8Zq8L6MxO4IbL/view> Mr. ANANDHARAJ T CER Document successfully cre

Dr. S. RAMABALAN, M.E., Ph.D.,
PRINCIPAL

E.G.S. Pillay Engineering College,
Thethi, Nagore - 611 002.
Nagapattinam (Dt) Tamil Nadu.

1AvxteNxsR94jImBeARIRI [https://drive.google.com/file/Mrs.V.Nivetha CERTIFICATE](https://drive.google.com/file/Mrs.V.Nivetha%20CERTIFICATE) Document successfully cre
1LEzZqSziBADfrNOABIk6l [https://drive.google.com/file/Ms.R.NIVASHINI CERTIFICATE](https://drive.google.com/file/Ms.R.NIVASHINI%20CERTIFICATE) Document successfully cre
1H3NiSSeulGNe_uLdrdXo [https://drive.google.com/file/Ms. SHAFRIN BEEVI CER](https://drive.google.com/file/Ms.SHAFRIN%20BEEVI%20CERTIFICATE) Document successfully cre
1WqqnL3zE_c502_u2thDli [https://drive.google.com/file/Mr. E.ARAVINDH CERTIF](https://drive.google.com/file/Mr.E.ARAVINDH%20CERTIFICATE) Document successfully cre
14YH6dV7X-1hCxEOjnxIC [https://drive.google.com/file/J.REXY JENIFER CERTIF](https://drive.google.com/file/J.REXY%20JENIFER%20CERTIFICATE) Document successfully cre
1q6yUZGeMmGQmV-54I4 [https://drive.google.com/file/Mr.SURESHRAJAN R CEI](https://drive.google.com/file/Mr.SURESHRAJAN%20R%20CERTIFICATE) Document successfully cre
1GbSVAQ-9ZSewtoxuTUc [https://drive.google.com/file/Ms.JANANI R CERTIFICA](https://drive.google.com/file/Ms.JANANI%20R%20CERTIFICATE) Document successfully cre
1-2pg9XovUGdV-6dPiFW: [https://drive.google.com/file/Mr.Mugesh.R CERTIFICA](https://drive.google.com/file/Mr.Mugesh.R%20CERTIFICATE) Document successfully cre
1d4oUE29lgMPypvxVzlij [https://drive.google.com/file/Prof.S.Jim Hawkinson CEf](https://drive.google.com/file/Prof.S.Jim%20Hawkinson%20CERTIFICATE) Document successfully cre
15HOeS_Ew18YdJsKxgh9 [https://drive.google.com/file/Mr.A.SUDHARSHAN CER](https://drive.google.com/file/Mr.A.SUDHARSHAN%20CERTIFICATE) Document successfully cre
1Wq09iON_aYXBldyTGku [https://drive.google.com/file/Mrs.SWETHA.S CERTIFIC](https://drive.google.com/file/Mrs.SWETHA.S%20CERTIFICATE) Document successfully cre
1jpJn-v5kOtCqZWF9JH2cl [https://drive.google.com/file/MOHAMED SHAGUL HAM](https://drive.google.com/file/MOHAMED%20SHAGUL%20HAM) Document successfully cre
1zWDpAwZm7x2HkG3yOI [https://drive.google.com/file/Mr.SAAJIDHULLAH I CER](https://drive.google.com/file/Mr.SAAJIDHULLAH%20I%20CERTIFICATE) Document successfully cre
1UxcAFWEC8KLux5VYO2 [https://drive.google.com/file/S.familiarufi CERTIFICATE](https://drive.google.com/file/S.familiarufi%20CERTIFICATE) Document successfully cre
1dv6lfz4k0boMoAZQ4pqg [https://drive.google.com/file/Mr THARIQ CERTIFICATE](https://drive.google.com/file/Mr.THARIQ%20CERTIFICATE) Document successfully cre
1BoSEpilf78qjxLZtCD6QIC [https://drive.google.com/file/MS.SIVASUKITHA.S CER](https://drive.google.com/file/MS.SIVASUKITHA.S%20CERTIFICATE) Document successfully cre
1TIGPbnW4surCmfIQTUY [https://drive.google.com/file/SRIDEVI.J CERTIFICATE](https://drive.google.com/file/SRIDEVI.J%20CERTIFICATE) Document successfully cre
1zv2Y_csFhy4QvrSe-E_e [https://drive.google.com/file/S. Sivakumar CERTIFICA](https://drive.google.com/file/S.Sivakumar%20CERTIFICATE) Document successfully cre
1ReKewf0REfaGUWcFXzl [https://drive.google.com/file/Mrs. Abirami.k CERTIFICA](https://drive.google.com/file/Mrs.Abirami.k%20CERTIFICATE) Document successfully cre
1534Pm5jn6iO_WpgA960t [https://drive.google.com/file/Mr VIGNESH S CERTIFIC](https://drive.google.com/file/Mr.VIGNESH%20S%20CERTIFICATE) Document successfully cre
150AtR_bmDzIHutyDruMx [https://drive.google.com/file/AKASH.K CERTIFICATE](https://drive.google.com/file/AKASH.K%20CERTIFICATE) Document successfully cre
1cABHDhTuSRhg2n1Nkr: [https://drive.google.com/file/Mr.Mani rathnam.A CERTI](https://drive.google.com/file/Mr.Mani%20rathnam.A%20CERTIFICATE) Document successfully cre
1rkXalEwusDB4x2dexIndE [https://drive.google.com/file/Ms.Lingeshwari.v CERTIFI](https://drive.google.com/file/Ms.Lingeshwari.v%20CERTIFICATE) Document successfully cre
1RLYHK4XjvKegp7hYjAqz [https://drive.google.com/file/Mr.JAYADEVAN N M CER](https://drive.google.com/file/Mr.JAYADEVAN%20N%20M%20CERTIFICATE) Document successfully cre
1xWM0FMRHQN8tR3Cyu: [https://drive.google.com/file/Mr. RAMGOPAL M CERTI](https://drive.google.com/file/Mr.RAMGOPAL%20M%20CERTIFICATE) Document successfully cre
1GVzR8TtvfX_YFcNraTN5 [https://drive.google.com/file/Gnanaprakasam s CERTIF](https://drive.google.com/file/Gnanaprakasam%20s%20CERTIFICATE) Document successfully cre
1BOR6ya4YPdfZ82lqnFrN [https://drive.google.com/file/ABINAYA, K CERTIFICAT](https://drive.google.com/file/ABINAYA,%20K%20CERTIFICATE) Document successfully cre
1cW1Tv1D6RdRuZ09HgY [https://drive.google.com/file/Dr.B.Gomathy CERTIFICA](https://drive.google.com/file/Dr.B.Gomathy%20CERTIFICATE) Document successfully cre
1z-n5G7XLAHBpgGnJI8r [https://drive.google.com/file/Mr T.SENTHIL KUMAR CE](https://drive.google.com/file/Mr.T.SENTHIL%20KUMAR%20CERTIFICATE) Document successfully cre
10kEgKCRMen02JsrSy2b [https://drive.google.com/file/Mr.B.JEGAN CERTIFICAT](https://drive.google.com/file/Mr.B.JEGAN%20CERTIFICATE) Document successfully cre
1UuUdW-rsFKUyflFP7_Zc [https://drive.google.com/file/DR. GV. SHRICHANDRAN](https://drive.google.com/file/DR.GV.%20SHRICHANDRAN) Document successfully cre
1cgpDtx93rdN8S1xyzCYH [https://drive.google.com/file/Ms.K.REVATHI CERTIFIC](https://drive.google.com/file/Ms.K.REVATHI%20CERTIFICATE) Document successfully cre
1-aKIIS7hGEeDt00IGXa4C [https://drive.google.com/file/Ms. G. Janani CERTIFICA](https://drive.google.com/file/Ms.G.Janani%20CERTIFICATE) Document successfully cre
1ZTf_Np-muGAHJtG7USd [https://drive.google.com/file/Mr. M. Nuthal Srinivasan C](https://drive.google.com/file/Mr.M.Nuthal%20Srinivasan%20CERTIFICATE) Document successfully cre

ATTESTED

Dr. S. RAMABALAN, M.E., Ph.D.,
PRINCIPAL
E.G.S. Pillay Engineering College,
Thethi, Nagore - 611 002,
Nagapattinam (Dt) Tamil Nadu.