



E.G.S. PILLAY ENGINEERING COLLEGE

(An Autonomous Institution, Affiliated to Anna University, Chennai)
Nagore Post, Nagapattinam – 611 002, Tamilnadu.



DEPARTMENT OF CIVIL ENGINEERING



Precious Enlightening Association of Civil Engineering (PEACE)

Organized Training Program on

“Laboratory Training for Technicians in Educational Institutions”

14/12/2020

ATTESTED

**Dr. S. RAMABALAN, M.E., Ph.D.,
PRINCIPAL**

E.G.S. Pillay Engineering College,
Thethi, Nagore - 611 002.
Nagapattinam (Dt) Tamil Nadu.



E.G.S. PILLAY ENGINEERING COLLEGE

(An Autonomous Institution, Affiliated to Anna University, Chennai)
Nagore Post, Nagapattinam – 611 002, Tamilnadu.



DEPARTMENT OF CIVIL ENGINEERING

Training Program on

“Laboratory Training for Technicians in Educational Institutions”

SL.NO	CONTENTS
1	Vision, Mission, PEO, PSO AND PO Statements
2	Summary of the Event
3	Approval Letters & Circulars
4	Invitation & Agenda
5	Participants Name List & Attendance
7	Sample Photos
8	Feedback Forms
9	Certificate

ATTESTED

Dr. S. RAMABALAN, M.E., Ph.D.,
PRINCIPAL

E.G.S. Pillay Engineering College,
Thethi, Nagore - 611 002.
Nagapattinam (Dt) Tamil Nadu.



E.G.S. PILLAY ENGINEERING COLLEGE
(An Autonomous Institution, Affiliated to Anna University, Chennai)
Nagore Post, Nagapattinam – 611 002, Tamilnadu.



DEPARTMENT OF CIVIL ENGINEERING

DEPARTMENT VISION

To evolve as a Centre of excellence by imparting quality technical education and promote research to meet the emerging challenges in the field of Civil Engineering.

DEPARTMENT MISSION

The Civil Engineering department is committed to

- M1:** Provide quality education through innovative teaching and learning practices.
- M2:** Encourage faculty and students to pursue higher education and carry out socially relevant innovative research thereby establishing centers of excellence in emerging areas of research.
- M3:** Offer consultancy services using state-of-the-art facilities fulfilling the needs of industry and society.
- M4:** Enable our students and faculty to play leadership roles in a sustainable manner by adopting professional ethics, entrepreneurship activities, interpersonal skills and a lifelong learning attitude.

PROGRAMME EDUCATIONAL OBJECTIVES (PEO's)

After successful completion of the programme, Graduates will be able to

- PEO1:** Become a successful Civil Engineer to meet the demand-driven needs in the field of Civil Engineering and related profession or pursue higher study and research or become an entrepreneur.
- PEO2:** Develop core competence by analyzing and design of Civil engineering systems with social awareness and responsibilities.
- PEO3:** Build professionalism, ethical approach, communication skills, and teamwork in their profession and adapt to modern trends by engaging in lifelong learning.

ATTESTED

Dr. S. RAMABALAN, M.E., Ph.D.,
PRINCIPAL
E.G.S. Pillay Engineering College,
Thethi, Nagore - 611 002.
Nagapattinam (Dt) Tamil Nadu.

PROGRAMME OUTCOMES (POs):

After successful completion of the programme, Graduates will be able to

- PO1** Application knowledge of mathematics, science, engineering fundamentals
- PO2** Problem Analysis.
- PO3** Design and Development of Solutions
- PO4** Conduct investigations by designing experiments, analysis and interpretation of data and synthesis of information to provide valid conclusions
- PO5** Modern Tool Usage
- PO6** Assessing societal, health, safety, legal and cultural issues
- PO7** Examining Environmental impact and Sustainability
- PO8** Commitment to professional ethics.
- PO9** Function effectively as an individual, and as a member or leader in diverse teams and in multi-disciplinary settings
- PO10** Communicate effectively at oral, written, and presentation level
- PO11** Examine Project Management and Financial aspects
- PO12** Instil Life-long Learning

PROGRAMME SPECIFIC OUTCOMES (PSOs):

After successful completion of the programme, students will be able to

PSO1: Analyze the effects of natural calamities like Tsunami, storms, earthquakes, landslides etc. in design of stable structures.

PSO2: Use eco-friendly materials and mechanisms for sustainable and life-line infrastructures.

ATTESTED

Dr. S. RAMABALAN, M.E., Ph.D.,
PRINCIPAL
E.G.S. Pillay Engineering College,
Thethi, Nagore - 611 002.
Nagapattinam (Dt) Tamil Nadu.



E.G.S. PILLAY ENGINEERING COLLEGE

(An Autonomous Institution, Affiliated to Anna University, Chennai)
Nagore Post, Nagapattinam – 611 002, Tamilnadu.



DEPARTMENT OF CIVIL ENGINEERING

Training Program on

“Laboratory Training for Technicians in Educational Institutions”

REPORT

Online Training Program on “Laboratory Training for Technicians in Educational Institutions” has been conducted for our Non-teaching Faculties and is organized by PEACE association, Department of Civil Engineering, E.G.S. Pillay Engineering College, Nagapattinam. The program was conducted on 14/12/2020. The Program was inaugurated with the welcome address by the event coordinator **Mr.G.Prakash, AP/Civil.**

Our Head of the Department, **Dr.S.Anand Kumar Varma, M.E.,Ph.D.**, gives the special address of the chief guest. **Mr. Hariharan**, Senior Manager, The Precision Scientific Co. (CBE), Thiruvarur gave a special keynote address and started his session. The participants learned about the handling and maintenance of various equipments. Finally, the session ended with a vote of thanks by **Dr.B.Vinodh Kumar, Assoc. Prof/Civil.**

Coordinators

G. Prakash
14/12/2020
(G.Prakash)

Dr.S.Anand Kumar Varma
14.12.20
HoD

(Dr.S.Anand Kumar Varma)

ATTESTED

Dr. S. Ramabalan
Dr. S. RAMABALAN, M.E., Ph.D.,
PRINCIPAL
E.G.S. Pillay Engineering College,
Thethi, Nagore - 611 002.
Nagapattinam (Dt) Tamil Nadu.

Requisition Letter

07/12/2020

From

G.Prakash
AP/Civil,
E.G.S. Pillay Engineering College,
Nagapattinam.

To

The Principal,
E.G.S. Pillay Engineering College,
Nagapattinam.

Respected Sir,

Sub: Requisition for permission to conduct training program – Reg

We have a plan to organize a one-day training program on "Laboratory Training for Technicians in Educational Institutions" through our PEACE association, Department of Civil Engineering on 14/12/2020. This will be very useful for non-teaching staff to understand the handling and maintenance of equipment in the laboratory. Hence, I request you to kindly permit to conduct the training program.

Thanking you,

For undersg
7.12.20

Yours faithfully

7/12/2020
G.Prakash

ATTESTED

Dr. S. RAMABALAN, M.E., Ph.D.,
PRINCIPAL
E.G.S. Pillay Engineering College,
Thethi, Nagore - 611 002.
Nagapattinam (Dt) Tamil Nadu.



E.G.S. PILLAY ENGINEERING COLLEGE
(An Autonomous Institution, Affiliated to Anna University, Chennai)
Nagore Post, Nagapattinam – 611 002, Tamilnadu.



DEPARTMENT OF CIVIL ENGINEERING

Date: 10/12/2020

CIRCULAR

Training Program on

“Laboratory Training for Technicians in Educational Institutions”

We cordially invite you that we are organizing one day Training Program on “Laboratory Training for Technicians in Educational Institutions” dated 14/12/2020, to enhance the knowledge. So, all are asked to participate and make the program a success in grant manner.

Coordinator

Sup
10/12/2020
(Mr.G.Prakash)

[Signature]
10.12.20
HoD

(Dr.S.Anand Kumar Varma)

Copy to: Principal.

ATTESTED

[Signature]
Dr. S. RAMABALAN, M.E., Ph.D.,
PRINCIPAL
E.G.S. Pillay Engineering College,
Thethi, Nagore - 611 002.
Nagapattinam (Dt) Tamil Nadu.



E.G.S. PILLAY
ENGINEERING COLLEGE

DEPARTMENT OF CIVIL ENGINEERING

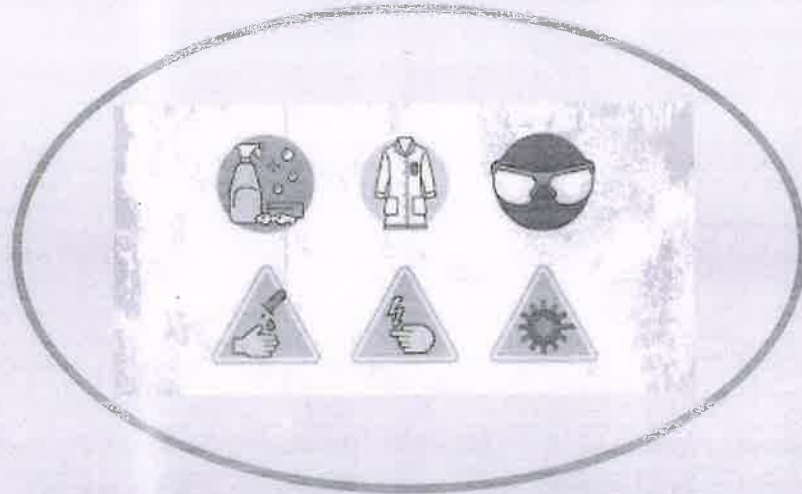

TRAINING PROGRAM ON
Laboratory Training for Technicians
in Educational Institutions

FREE
ENTRY!

RESOURCE PERSON:
MR. HARIHARAN,
SENIOR MANAGER,
THE PRECISION SCIENTIFIC CO. (CBE),

14
DECEMBER
2020
10 AM

ATTESTED

Dr. S. RAMABALAN, M.E., Ph.D.,
PRINCIPAL
E.G.S. Pillay Engineering College,
Thethi, Nagore - 611 002.
Nagapattinam (Dt) Tamil Nadu.



E.G.S. PILLAY ENGINEERING COLLEGE

(An Autonomous Institution, Affiliated to Anna University, Chennai)
Nagore Post, Nagapattinam – 611 002, Tamilnadu.



DEPARTMENT OF CIVIL ENGINEERING

Training Program on

“Laboratory Training for Technicians in Educational Institutions”

Program Schedule (14/12/2020)

Session	Event
10.00 a.m. to 10.15 a.m.	<p><u>Inaugural Function:</u></p> <p><i>Welcome address:</i> Mr.G.Prakash, AP/Civil.</p> <p><i>Speaker address:</i> Dr.S.Anand Kumar Varma, Prof & Head, Civil</p>
10.15 a.m. to 12.00 p.m.	<p><u>Speakers:</u></p> <p>Mr. Hariharan, Senior Manager, The Precision Scientific Co. (CBE), Thiruvarur</p>
12.00 p.m.	<p><u>Vote of thanks:</u></p> <p>Dr.B.Vinodh Kumar, Assoc. Prof/Civil</p>

ATTESTED

Dr. S. RAMABALAN, M.E., Ph.D.,
PRINCIPAL
E.G.S. Pillay Engineering College,
Thethi, Nagore - 611 002.
Nagapattinam (Dt) Tamil Nadu,

Bio of Mr.Hariharan, Senior Manager, The Precision Scientific Co. (CBE), Thiruvarur

Mr.Hariharan has 35 years of experience in the field of laboratory sales and service. Now he is the senior manager and branch manager of Thiruvarur. The Precision Scientific Co(cbe)., started about 40 years back to cater to the field of science they have established itself as a leading company in Tamilnadu. Head Office at Coimbatore & Branch at Trichy are located at the heart of the city with own spacious buildings with the latest infrastructure and a young sales force.We are leading stockists for leading brands of laboratory instruments, chemicals and glasswares (Indian, Imported).

Company Profile

Year of Establishment	:	1967
Legal Status of Firm	:	Proprietorship
Income Tax Registration No	:	Accopc4845p
Vat No	:	33292160025
I.E.C.NO	:	3202008773
Nature of Business	:	Scientific Equipments, Lab Chemicals & Glasswares.
Team & Staff	:	Science Graduates
Total Number Of Employees	:	25

ATTESTED

Dr. S. RAMABALAN, M.E., Ph.D.,
PRINCIPAL
E.G.S. Pillay Engineering College,
Thethi, Nagore - 611 002.
Nagapattinam (Dt) Tamil Nadu.



E.G.S. PILLAY ENGINEERING COLLEGE

(An Autonomous Institution, Affiliated to Anna University, Chennai)
Nagore Post, Nagapattinam – 611 002, Tamilnadu.



DEPARTMENT OF CIVIL ENGINEERING

Training Program on

“Laboratory Training for Technicians in Educational Institutions”

14/12/2020

Participants Attendance

S.No	Name	Department	FN	AN
1.	V.Rajakumar	Civil		
2.	N.Prasanth	Civil		
3.	Thiyagu	Civil		
4.	Sakthivel	Civil		
5.	N.Vijay	Civil		
6.	Ramamoorthy	Civil		
7.	R.Sathish Kumar	Civil		
8.	S. Sakthivel	Mechanical		
9.	S.Venkatesan	Mechanical		
10.	R.Rajasekaran	Mechanical		
11.	S.Ramamoorthy	Mechanical		
12.	Chellappa	Mechanical		
13.	V.Ramu	Mechanical		
14.	S.Joseph	Mechanical		
15.	Nagarajan	EEE		

ATTESTED

Dr. S. RAMABALAN, M.E., Ph.D.,
PRINCIPAL

E.G.S. Pillay Engineering College,
Thethi, Nagore - 611 002.
Nagapattinam (Dt) Tamil Nadu.



ATTESTED

**Dr. S. RAMABALAN, M.E., Ph.D.,
PRINCIPAL**

**E.G.S. Pillay Engineering College,
Thethi, Nagore - 611 002.
Nagapattinam (Dt) Tamil Nadu.**

E.G.S. PILLAY ENGINEERING COLLEGE, NAGAPATTINAM.

FEEDBACK FORM

Name of the Department : Civil Engineering
Nature of the event : Training Program
Title of the Event : "Laboratory Training for Technicians in Educational Institutions"
Resource Person : Mr.Hariharan
Date : 14/12/2020
Coordinators Name : G.Prakash

Ratings have been provided on a 5-point scale

You strongly disagree with the statement - 1
You disagree with the statement - 2
You neither agree nor disagree with the statement - 3
You agree with the statement - ~~4~~
You strongly agree with the statement - 5

About the Content of the Program

The Program content was relevant for me ~~5~~ 4 3 2 1
The content of the program was very comprehensive 5 ~~4~~ 3 2 1
The content of the program was not repeated ~~5~~ 4 3 2 1
The overall content of the program was excellent ~~5~~ 4 3 2 1

About Resource person and Presentation

The speaker had very strong expertise in areas ~~5~~ 4 3 2 1
The speaker had excellent communication skills 5 ~~4~~ 3 2 1
The speaker made the program very interesting 5 ~~4~~ 3 2 1
The speaker was very well prepared for program ~~5~~ 4 3 2 1

About the Guest Lecture

The timings were very convenient 5 ~~4~~ 3 2 1
The pedagogy used as very appropriate 5 ~~4~~ 3 2 1
There were sufficient breaks in between sessions ~~5~~ 4 3 2 1

Assessment

The assessment was very suitable ~~5~~ 4 3 2 1
The assessment was not at all difficult 5 ~~4~~ 3 2 1

This question is answered on a 10-point scale with 1 being highly unlikely to recommend and 10 being will highly recommend.

Overall Experience 1 2 3 4 5 6 7 8 9 10

Name : S. Venkatesan

Signature : SV

ATTESTED

Dr. S. RAMABALAN, M.E., Ph.D.,
PRINCIPAL

E.G.S. Pillay Engineering College,
Thethi, Nagore - 611 002.
Nagapattinam (Dt) Tamil Nadu.

E.G.S. PILLAY ENGINEERING COLLEGE, NAGAPATTINAM.

FEEDBACK FORM

Name of the Department : Civil Engineering
Nature of the event : Training Program
Title of the Event : "Laboratory Training for Technicians in Educational Institutions"
Resource Person : Mr.Hariharan
Date : 14/12/2020
Coordinators Name : G.Prakash

Ratings have been provided on a 5-point scale

You strongly disagree with the statement - 1
 You disagree with the statement - 2
 You neither agree nor disagree with the statement - 3
 You agree with the statement - 4
 You strongly agree with the statement - 5

About the Content of the Program

The Program content was relevant for me	5	4	3	2	1
The content of the program was very comprehensive	5	4	3	2	1
The content of the program was not repeated	5	4	3	2	1
The overall content of the program was excellent	5	4	3	2	1

About Resource person and Presentation

The speaker had very strong expertise in areas	5	4	3	2	1
The speaker had excellent communication skills	5	4	3	2	1
The speaker made the program very interesting	5	4	3	2	1
The speaker was very well prepared for program	5	4	3	2	1

About the Guest Lecture

The timings were very convenient	5	4	3	2	1
The pedagogy used as very appropriate	5	4	3	2	1
There were sufficient breaks in between sessions	5	4	3	2	1

Assessment

The assessment was very suitable	5	4	3	2	1
The assessment was not at all difficult	5	4	3	2	1

This question is answered on a 10-point scale with 1 being highly unlikely to recommend and 10 being will highly recommend.

Overall Experience 1 2 3 4 5 6 7 8 9 10

Name : S. Joseph

Signature : 

ATTESTED



**Dr. S. RAMABALAN, M.E., Ph.D.,
PRINCIPAL**

E.G.S. Pillay Engineering College,
Thethi, Nagore - 611 002.
Nagapattinam (Dt) Tamil Nadu.

E.G.S. PILLAY ENGINEERING COLLEGE, NAGAPATTINAM.

FEEDBACK FORM

Name of the Department : Civil Engineering
 Nature of the event : Training Program
 Title of the Event : "Laboratory Training for Technicians in Educational Institutions"
 Resource Person : Mr.Hariharan
 Date : 14/12/2020
 Coordinators Name : G.Prakash

Ratings have been provided on a 5-point scale

You strongly disagree with the statement - 1
 You disagree with the statement - 2
 You neither agree nor disagree with the statement - 3
 You agree with the statement - 4
 You strongly agree with the statement - ~~5~~

About the Content of the Program

The Program content was relevant for me	5	4	3	2	1
The content of the program was very comprehensive	5	4	3	2	1
The content of the program was not repeated	5	4	3	2	1
The overall content of the program was excellent	5	4	3	2	1

About Resource person and Presentation

The speaker had very strong expertise in areas	5	4	3	2	1
The speaker had excellent communication skills	5	4	3	2	1
The speaker made the program very interesting	5	4	3	2	1
The speaker was very well prepared for program	5	4	3	2	1

About the Guest Lecture

The timings were very convenient	5	4	3	2	1
The pedagogy used as very appropriate	5	4	3	2	1
There were sufficient breaks in between sessions	5	4	3	2	1

Assessment

The assessment was very suitable	5	4	3	2	1
The assessment was not at all difficult	5	4	3	2	1

This question is answered on a 10-point scale with 1 being highly unlikely to recommend and 10 being will highly recommend.

Overall Experience 1 2 3 4 5 6 7 8 ~~9~~ 10

Name : V. Rajakumar

Signature :  14/12/20

ATTESTED

Dr. S. RAMABALAN, M.E., Ph.D.,
PRINCIPAL
 E.G.S. Pillay Engineering College,
 Thethi, Nagore - 611 002.
 Nagapattinam (Dt) Tamil Nadu.

E.G.S. PILLAY ENGINEERING COLLEGE, NAGAPATTINAM.

FEEDBACK FORM

Name of the Department : Civil Engineering
Nature of the event : Training Program
Title of the Event : "Laboratory Training for Technicians in Educational Institutions"
Resource Person : Mr.Hariharan
Date : 14/12/2020
Coordinators Name : G.Prakash

Ratings have been provided on a 5-point scale

You strongly disagree with the statement - 1
You disagree with the statement - 2
You neither agree nor disagree with the statement - 3
You agree with the statement - 4
You strongly agree with the statement - 5

About the Content of the Program

The Program content was relevant for me	<input checked="" type="checkbox"/> 5	4	3	2	1
The content of the program was very comprehensive	5	<input checked="" type="checkbox"/> 4	3	2	1
The content of the program was not repeated	<input checked="" type="checkbox"/> 5	4	3	2	1
The overall content of the program was excellent	5	<input checked="" type="checkbox"/> 4	3	2	1

About Resource person and Presentation

The speaker had very strong expertise in areas	<input checked="" type="checkbox"/> 5	4	3	2	1
The speaker had excellent communication skills	5	4	3	2	1
The speaker made the program very interesting	5	<input checked="" type="checkbox"/> 4	<input checked="" type="checkbox"/> 3	2	1
The speaker was very well prepared for program	5	4	3	2	1

About the Guest Lecture

The timings were very convenient	<input checked="" type="checkbox"/> 5	4	3	2	1
The pedagogy used as very appropriate	5	<input checked="" type="checkbox"/> 4	3	2	1
There were sufficient breaks in between sessions	<input checked="" type="checkbox"/> 5	4	3	2	1

Assessment

The assessment was very suitable	<input checked="" type="checkbox"/> 5	4	3	2	1
The assessment was not at all difficult	5	<input checked="" type="checkbox"/> 4	3	2	1

This question is answered on a 10-point scale with 1 being highly unlikely to recommend and 10 being will highly recommend.

Overall Experience 1 2 3 4 5 6 7 8 9 10

Name : Chellappa

Signature : 

ATTESTED

Dr. S. RAMABALAN, M.E., Ph.D.,
PRINCIPAL

E.G.S. Pillay Engineering College,
Thethi, Nagore - 611 002.
Nagapattinam (Dt) Tamil Nadu.

E.G.S. PILLAY ENGINEERING COLLEGE, NAGAPATTINAM.

FEEDBACK FORM

Name of the Department : Civil Engineering
Nature of the event : Training Program
Title of the Event : "Laboratory Training for Technicians in Educational Institutions"
Resource Person : Mr.Hariharan
Date : 14/12/2020
Coordinators Name : G.Prakash

Ratings have been provided on a 5-point scale

You strongly disagree with the statement - 1
 You disagree with the statement - 2
 You neither agree nor disagree with the statement - 3
 You agree with the statement - 4
 You strongly agree with the statement - 5

About the Content of the Program

The Program content was relevant for me 5 4 3 2 1
 The content of the program was very comprehensive 5 4 3 2 1
 The content of the program was not repeated 5 4 3 2 1
 The overall content of the program was excellent 5 4 3 2 1

About Resource person and Presentation

The speaker had very strong expertise in areas 5 4 3 2 1
 The speaker had excellent communication skills 5 4 3 2 1
 The speaker made the program very interesting 5 4 3 2 1
 The speaker was very well prepared for program 5 4 3 2 1

About the Guest Lecture

The timings were very convenient 5 4 3 2 1
 The pedagogy used as very appropriate 5 4 3 2 1
 There were sufficient breaks in between sessions 5 4 3 2 1

Assessment

The assessment was very suitable 5 4 3 2 1
 The assessment was not at all difficult 5 4 3 2 1

This question is answered on a 10-point scale with 1 being highly unlikely to recommend and 10 being will highly recommend.

Overall Experience 1 2 3 4 5 6 7 8 9 10

Name : R. Sathishkumar

Signature : R. Sathishkumar 14/12/2020

ATTESTED

Dr. S. RAMABALAN, M.E., Ph.D.,
PRINCIPAL
 E.G.S. Pillay Engineering College,
 Thethi, Nagore - 611 002.
 Nagapattinam (Dt) Tamil Nadu.

CERTIFICATE

This Certificate is Proudly Presented to

S. Venkatesan

From E.G.S.Pillay Engineering College

has attended the training Program on "Laboratory Training for Technicians in Educational Institutions" organized by Department of Civil Engineering, E.G.S.Pillay Engineering College (Autonomous), Nagapattinam on 14th December 2020.

[Signature]

Coordinator

[Signature]

HOD

ATTESTED

[Signature]

Dr. S. RAMABALAN, M.E., Ph.D.,
PRINCIPAL

E.G.S. Pillay Engineering College,
Thethi, Nagore - 611 002.
Nagapattinam (Dt) Tamil Nadu.

CERTIFICATE

This Certificate is Proudly Presented to

S. Joseph

From E.G.S.Pillay Engineering College

has attended the training Program on "Laboratory Training for Technicians in Educational Institutions" organized by Department of Civil Engineering, E.G.S.Pillay Engineering College (Autonomous), Nagapattinam on 14th December 2020.

[Signature]

Coordinator

[Signature]

HOD

ATTESTED

[Signature]

**Dr. S. RAMABALAN, M.E., Ph.D.,
PRINCIPAL**

E.G.S. Pillay Engineering College,
Thethi, Nagore - 611 002.
Nagapattinam (Dt) Tamil Nadu.

CERTIFICATE

This Certificate is Proudly Presented to

V. Ramu

From **E.G.S.Pillay Engineering College**

has attended the training Program on "Laboratory Training for Technicians in Educational Institutions" organized by Department of Civil Engineering, E.G.S.Pillay Engineering College (Autonomous), Nagapattinam on 14th December 2020.

[Signature]

Coordinator

[Signature]

HOD

ATTESTED

[Signature]

Dr. S. RAMABALAN, M.E., Ph.D.,
PRINCIPAL

E.G.S. Pillay Engineering College,
Thethi, Nagore - 611 002.
Nagapattinam (Dt) Tamil Nadu.

CERTIFICATE

This Certificate is Proudly Presented to

S. Thiyagu

From **E.G.S.Pillay Engineering College**

has attended the training Program on "Laboratory Training for Technicians in Educational Institutions" organized by Department of Civil Engineering, **E.G.S.Pillay Engineering College (Autonomous), Nagapattinam** on 14th December 2020.



Coordinator



HOD

ATTESTED



**Dr. S. RAMABALAN, M.E., Ph.D.,
PRINCIPAL**

E.G.S. Pillay Engineering College,
Thethi, Nagore - 611 002.
Nagapattinam (Dt) Tamil Nadu.

CERTIFICATE

This Certificate is Proudly Presented to

Ramamurthy

From **E.G.S.Pillay Engineering College**

has attended the training Program on "Laboratory Training for Technicians in Educational Institutions" organized by Department of Civil Engineering, E.G.S.Pillay Engineering College (Autonomous), Nagapattinam on 14th December 2020.



Coordinator



HOD

ATTESTED



**Dr. S. RAMABALAN, M.E., Ph.D.,
PRINCIPAL**

E.G.S. Pillay Engineering College,
Thethi, Nagore - 611 002.
Nagapattinam (Dt) Tamil Nadu.



E.G.S. PILLAY ENGINEERING COLLEGE

(An Autonomous Institution, Affiliated to Anna University, Chennai)
Nagore Post, Nagapattinam – 611 002, Tamilnadu.



DEPARTMENT OF CIVIL ENGINEERING



Precious Enlightening Association of Civil Engineering (PEACE)

Organized Webinar on

“Climate Change and their Impacts”

18th November 2020

ATTESTED

**Dr. S. RAMABALAN, M.E., Ph.D.,
PRINCIPAL**

E.G.S. Pillay Engineering College,
Thethi, Nagore - 611 002.
Nagapattinam (Dt) Tamil Nadu.



E.G.S. PILLAY ENGINEERING COLLEGE

(An Autonomous Institution, Affiliated to Anna University, Chennai)
Nagore Post, Nagapattinam – 611 002, Tamilnadu.



DEPARTMENT OF CIVIL ENGINEERING

Webinar on

“Climate Change and their Impacts”

SL.NO	CONTENTS
1	Vision, Mission, PEO, PSO AND PO Statements
2	Summary of the Event
3	Approval Letters & Circulars
4	Invitation & Agenda
5	Participants Name List & Attendance
7	Sample Photos
8	Feedback Forms
9	Certificate

ATTESTED

Dr. S. RAMABALAN, M.E., Ph.D.,
PRINCIPAL

E.G.S. Pillay Engineering College,
Thethi, Nagore - 611 002.
Nagapattinam (Dt) Tamil Nadu.



E.G.S. PILLAY ENGINEERING COLLEGE
(An Autonomous Institution, Affiliated to Anna University, Chennai)
Nagore Post, Nagapattinam – 611 002, Tamilnadu.



DEPARTMENT OF CIVIL ENGINEERING

DEPARTMENT VISION

To evolve as a Centre of excellence by imparting quality technical education and promote research to meet the emerging challenges in the field of Civil Engineering.

DEPARTMENT MISSION

The Civil Engineering department is committed to

- M1:** Provide quality education through innovative teaching and learning practices.
- M2:** Encourage faculty and students to pursue higher education and carry out socially relevant innovative research thereby establishing centers of excellence in emerging areas of research.
- M3:** Offer consultancy services using state-of-the-art facilities fulfilling the needs of the industry and society.
- M4:** Enable our students and faculty to play leadership roles in a sustainable manner by adopting professional ethics, entrepreneurship activities, interpersonal skills and a lifelong learning attitude.

PROGRAMME EDUCATIONAL OBJECTIVES (PEO's)

After successful completion of the programme, Graduates will be able to

- PEO1:** Become a successful Civil Engineer to meet the demand-driven needs in the field of Civil Engineering and related profession or pursue higher study and research or become an entrepreneur.
- PEO2:** Develop core competence by analyzing and design of Civil engineering systems with social awareness and responsibilities.
- PEO3:** Build professionalism, ethical approach, communication skills, and teamwork in their profession and adapt to modern trends by engaging in lifelong learning.

ATTESTED

Dr. S. RAMABALAN, M.E., Ph.D.
PRINCIPAL
E.G.S. Pillay Engineering College,
Thethi, Nagore - 611 002.
Nagapattinam (Dt) Tamil Nadu.

PROGRAMME OUTCOMES (POs):

After successful completion of the programme, Graduates will be able to

- PO1** Application knowledge of mathematics, science, engineering fundamentals
- PO2** Problem Analysis.
- PO3** Design and Development of Solutions
- PO4** Conduct investigations by designing experiments, analysis and interpretation of data and synthesis of information to provide valid conclusions
- PO5** Modern Tool Usage
- PO6** Assessing societal, health, safety, legal and cultural issues
- PO7** Examining Environmental impact and Sustainability
- PO8** Commitment to professional ethics.
- PO9** Function effectively as an individual, and as a member or leader in diverse teams and in multi-disciplinary settings
- PO10** Communicate effectively at oral, written, and presentation level
- PO11** Examine Project Management and Financial aspects
- PO12** Instil Life-long Learning

PROGRAMME SPECIFIC OUTCOMES (PSOs):

After successful completion of the programme, students will be able to

PSO1: Analyze the effects of natural calamities like Tsunami, storms, earthquakes, landslides etc. in design of stable structures.

PSO2: Use eco-friendly materials and mechanisms for sustainable and life-line infrastructures.

ATTESTED



**Dr. S. RAMABALAN, M.E., Ph.D.,
PRINCIPAL**

**E.G.S. Pillay Engineering College,
Thethi, Nagore - 611 002.
Nagapattinam (Dt) Tamil Nadu.**



E.G.S. PILLAY ENGINEERING COLLEGE

(An Autonomous Institution, Affiliated to Anna University, Chennai)
Nagore Post, Nagapattinam – 611 002, Tamilnadu.



DEPARTMENT OF CIVIL ENGINEERING

Webinar on “Climate Change and their Impacts”

REPORT

One day Online Webinar on “Climate Change and their Impacts” has been conducted for our faculties is organized by PEACE association, Department of Civil Engineering, E.G.S. Pillay Engineering College, Nagapattinam. The program was conducted on 18th November 2020. Our senior faculty Ms.P.Malliga, Assoc. Prof/Civil, welcomes the Chief guest & Speaker. Our Head of the Department, Dr.S.Anand Kumar Varma), M.E., Ph.D., introduced the Resource person to the participants. Our Resource person gave a special keynote address and started his session. The participants learned in detail about “Climate Change and their Impacts”. Finally, the session ended with a vote of thanks by the event coordinator Mr.S.Shyam Sundar, AP/Civil.

Coordinators

(S.Shyam Sundar)

HoD 18-11-20

(Dr.S.Anand Kumar Varma)

ATTESTED

Dr. S. RAMABALAN, M.E., Ph.D.,
PRINCIPAL

E.G.S. Pillay Engineering College,
Thethi, Nagore - 611 002.
Nagapattinam (Dt) Tamil Nadu.

11/11/2020
Nagapattinam

From

S.Shyam Sundar
Assistant Professor
Department of Civil Engineering,
E.G.S. Pillay Engineering College,
Nagapattinam.

To

The Principal
E.G.S. Pillay Engineering College,
Nagapattinam.

Through

The Head of the Department,
Department of Civil Engineering,
E.G.S. Pillay Engineering College,
Nagapattinam.

Respected Sir,

Sub: Seeking Permission to conduct one day Online Webinar – Reg

We, PEACE association of Department of Civil Engineering, have a plan to organize a one-day Online Webinar on “Climate Change and their Impacts” dated 18/11/2020. Hence, we request you to kindly give us permission to conduct the Online Webinar and kindly support us for the successful completion of the event.

Thanking you,

Yours faithfully

(S.Shyam Sundar)

ATTESTED

Dr. S. RAMABALAN, M.E., Ph.D.,
PRINCIPAL

E.G.S. Pillay Engineering College,
Thethi, Nagore - 611 002.
Nagapattinam (Dt) Tamil Nadu.



E.G.S. PILLAY ENGINEERING COLLEGE
(An Autonomous Institution, Affiliated to Anna University, Chennai)
Nagore Post, Nagapattinam – 611 002, Tamilnadu.



DEPARTMENT OF CIVIL ENGINEERING

Date: 16/11/2020

CIRCULAR

Online webinar on “Climate Change and their Impacts”

We cordially invite you that we are organizing one day Online Webinar on “Climate Change and their Impacts” dated 18/11/2020, to enhance the knowledge on Standards. So, all are asked to participate and make the program a success in grant manner.

Coordinator

(S. Shyam Sundar)

HoD 16.11.20

(Dr. S. Anand Kumar Varma)

Copy to: Principal.

ATTESTED

Dr. S. RAMABALAN, M.E., Ph.D.,
PRINCIPAL
E.G.S. Pillay Engineering College,
Thethi, Nagore - 611 002.
Nagapattinam (Dt) Tamil Nadu.



E.G.S. PILLAY ENGINEERING COLLEGE

**(An Autonomous Institution,
Affiliated to Anna University, Chennai)
Nagapattinam - 611 002, Tamilnadu.**

Department of Civil Engineering and



PEACE Association

Online Webinar on

“Climate Change and their Impacts”

Registration Link

<https://forms.gle/cRf486UxhPt8Man48>

Resource Person:

**Dr.N.Ilavarasan,
HOD-Civil,
BIT Campus,
Anna University,
Tiruchirappalli**



18 November 2020



hodcivil@egspec.org



+91-9159593377

ATTESTED

**Dr. S. RAMABALAN, M.E., Ph.D.,
PRINCIPAL**

**E.G.S. Pillay Engineering College,
Thethi, Nagore - 611 002.
Nagapattinam (Dt) Tamil Nadu.**

Resource Person Profile

1. **Name of the Faculty: Mr.N.Ilavarasan**
2. **Department and Designation: Civil Engineering & Assistant Professor**
3. **Date of Joining: 26.08.2009**
4. **Faculty ID: TF0067**
5. **E-mail Address: k13071981k@gmail.com**
6. **Date of Birth: 13.07.1981**
7. **Qualification: B.E., M.E.**
8. **Specialization: Water Resources Engineering**
9. **Professional Experience: 12 Years**
10. **Research Guidance: 34**
11. **Publications**
 - (i) **Internationally Refereed Journals: (along with Impact Factor)**
 - (ii) **National Journals: 2**
 - (iii) **International Conferences: 1**
 - (iv) **National Conferences: 1**
12. **CONFERENCES/WORKSHOPS/SEMINAR/ SHORT TERM REFRESHER COURSE ATTENDED: 5**
13. **15. CONFERENCES/WORKSHOPS/SEMINAR ORGANISED: 2**



ATTESTED

Dr. S. RAMABALAN, M.E., Ph.D.,
PRINCIPAL
E.G.S. Pillay Engineering College,
Thethi, Nagore - 611 002.
Nagapattinam (Dt) Tamil Nadu.



E.G.S. PILLAY ENGINEERING COLLEGE

(An Autonomous Institution, Affiliated to Anna University, Chennai)
Nagore Post, Nagapattinam – 611 002, Tamilnadu.



DEPARTMENT OF CIVIL ENGINEERING

Webinar on “Climate Change and their Impacts”

Program Schedule

Session	Event
10.00 a.m. to 10.15 a.m.	<u>Inaugural Function:</u> <i>Welcome address: P.Malliga, Assoc. Prof/ Civil</i> <i>Speaker address: Dr.R.Sivakumar, Prof & Head, Civil</i>
10.15 a.m. to 10.30 a.m.	Tea Break
10.30 a.m. to 1.00 p.m.	<u>Resource Person:</u> Dr.N.Ilavarasan, HOD-Civil, BIT Campus, Anna University, Tiruchirappalli
1.00 p.m. to 1.15 p.m.	<u>Vote of Thanks:</u> N.Karthika, AP/Civil.

ATTESTED

Dr. S. RAMABALAN, M.E., Ph.D.,
PRINCIPAL

E.G.S. Pillay Engineering College,
Thethi, Nagore - 611 002.
Nagapattinam (Dt) Tamil Nadu.



E.G.S. PILLAY ENGINEERING COLLEGE
(An Autonomous Institution, Affiliated to Anna University, Chennai)
Nagore Post, Nagapattinam – 611 002, Tamilnadu.



DEPARTMENT OF CIVIL ENGINEERING

Webinar on
“Climate Change and their Impacts”

Participants Name List

1. Dr.S.Anand Kumar Varma
2. Dr.R.Sivakumar
3. Dr.V.Sekaran
4. Dr.N.Sakthieswaran
5. Dr.R.Elliss Yogesh
6. Dr.B.Vinodhkumar
7. Mrs.P.Malliga
8. Mr.V.Balasubramani
9. Mr.A.Arjunan
10. Mr.N.R.Vethamoorthy
11. Mr.G.Prakash
12. Ms.R.Neelaveni
13. Mrs.M.Subita Deeneshwari
14. Ms.N.Karthika
15. Mrs.K.Kamalarani
16. Mr.T.Adhavanathan
17. Mr.S.Shyam Sundar
18. Mr.E.Venkatesan
19. Mr.J.Britto
20. Mr.K.Senthamilmaran
21. Mr.V.Srinivasan
22. Mr.A.Pirakasam
23. Mr.P.Bharath
24. Ms.G.Durga
25. Ms.N.Sasirega
26. Ms.T.J.Saranya
27. Mr.V.C.Keerthi
28. Mr.S.Santhoshkumar
29. Mr.S.Venkatramanan
30. Ms.K.Shakila
31. Mr.Sundhar
32. Ms.G.Nithya

ATTESTED

Dr. S. RAMABALAN, M.E., Ph.D.,
PRINCIPAL
E.G.S. Pillay Engineering College,
Thethi, Nagore - 611 002.
Nagapattinam (Dt) Tamil Nadu.

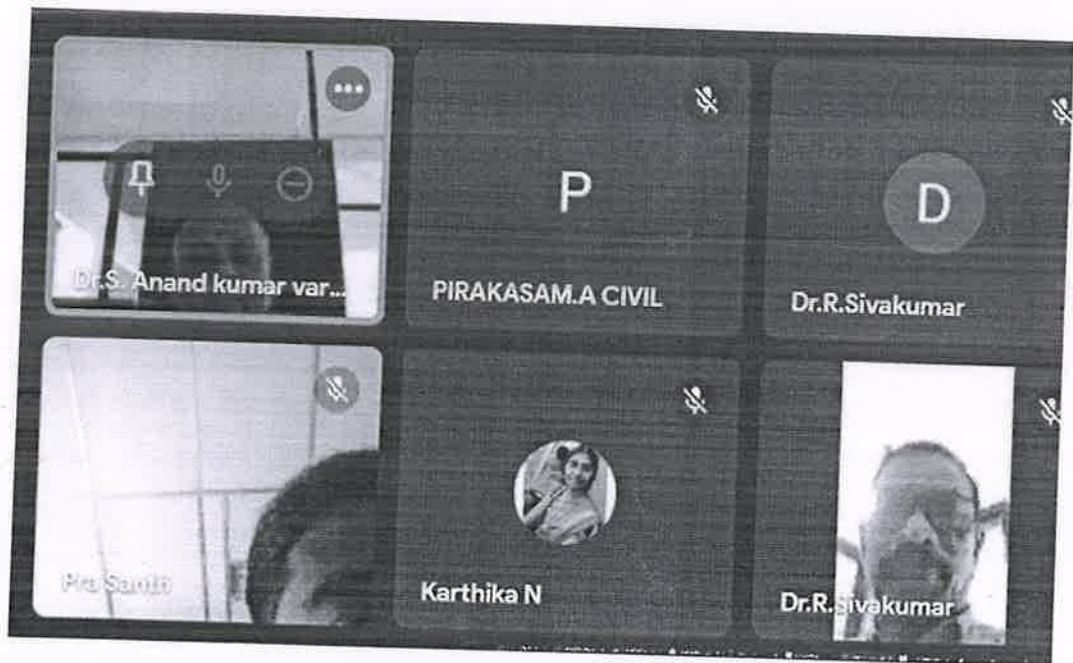

ATTESTED

Dr. S. RAMABALAN, M.E., Ph.D.,
PRINCIPAL
E.G.S. Pillay Engineering College,
Thethi, Nagore - 611 002.
Nagapattinam (Dt) Tamil Nadu.

Timestamp	Name & Designation	College Name	The workshop content	The content of the wori	The registration proces	The Audio and Video	The content of the wori	The OVERALL content
7-26-2021 15:55:52	Vinodhikumar B	Egsspec	Strongly disagree	Agree	Neutral	Neutral	Disagree	Neutral
7-26-2021 16:43:58	Sundhar K B	Egsspec	Disagree	Strongly disagree	Strongly disagree	Strongly disagree	Neutral	Agree
7-26-2021 16:52:53	Venkatesan E	Egsspec	Strongly agree	Agree	Agree	Agree	Agree	Strongly disagree
7-26-2021 16:52:56	Venkatramanan S	Egsspec	Strongly disagree	Strongly disagree	Strongly disagree	Strongly disagree	Strongly disagree	Agree
7-26-2021 16:53:07	Vethamoorthy N R	Egsspec	Neutral	Strongly disagree	Strongly disagree	Strongly disagree	Strongly disagree	Strongly disagree
7-26-2021 16:53:51	Subita Deeneshwari M	Egsspec	Agree	Agree	Agree	Agree	Agree	Strongly disagree
7-26-2021 16:53:53	Srinivasan V	Egsspec	Agree	Neutral	Neutral	Agree	Agree	Agree
7-26-2021 16:55:52	Sivakumar R	Egsspec	Strongly disagree	Strongly disagree	Strongly disagree	Strongly disagree	Strongly disagree	Strongly disagree
7-26-2021 16:55:54	Shyam Sundar S	Egsspec	Agree	Agree	Agree	Agree	Agree	Strongly disagree
7-26-2021 16:58:11	Shakila K	Egsspec	Strongly agree	Strongly agree	Strongly agree	Strongly agree	Strongly agree	Agree
7-26-2021 16:58:19	Senthamil Maran K	Egsspec	Agree	Strongly agree	Agree	Agree	Disagree	Disagree
7-26-2021 16:58:25	Sekaran V	Egsspec	Neutral	Strongly agree	Agree	Agree	Agree	Agree
7-26-2021 17:59:12	Neelaveni R	Egsspec	Neutral	Neutral	Neutral	Neutral	Neutral	Neutral
7-27-2021 17:59:12	Nithya G	Egsspec	Strongly agree	Strongly agree	Strongly agree	Strongly agree	Strongly agree	Strongly agree
7-28-2021 17:59:12	Pirakasam A	Egsspec	Disagree	Strongly disagree	Strongly disagree	Strongly disagree	Strongly disagree	Strongly disagree
7-29-2021 17:59:12	Prakash G	Egsspec	Strongly agree	Agree	Agree	Agree	Agree	Agree
7-26-2021 18:53:51	Sakthieswaran N	Egsspec	Strongly disagree	Strongly disagree	Strongly disagree	Strongly disagree	Strongly disagree	Strongly disagree
7-26-2021 18:53:53	Santhoshkumar S	Egsspec	Neutral	Strongly disagree	Strongly disagree	Strongly disagree	Strongly disagree	Strongly disagree
7-26-2021 18:55:52	Saranya T J	Egsspec	Agree	Agree	Agree	Agree	Agree	Agree
7-26-2021 18:52:53	Sasirega N	Egsspec	Agree	Agree	Agree	Agree	Agree	Agree
7-26-2021 16:52:56	Malliga P	Egsspec	Strongly agree	Strongly agree	Strongly agree	Strongly agree	Strongly agree	Agree
7-26-2021 16:53:07	Keerthi V C	Egsspec	Agree	Strongly agree	Strongly agree	Strongly agree	Strongly agree	Agree
7-26-2021 16:53:51	Karthika N	Egsspec	Neutral	Agree	Agree	Agree	Disagree	Disagree
7-26-2021 17:59:12	Kamalarani K	Egsspec	Strongly agree	Neutral	Neutral	Neutral	Agree	Agree
7-27-2021 17:59:12	EllisVogesh R	Egsspec	Disagree	Strongly agree	Strongly agree	Strongly agree	Strongly agree	Neutral
7-28-2021 17:59:12	Durga G	Egsspec	Strongly agree	Strongly disagree	Strongly disagree	Strongly disagree	Strongly disagree	Strongly disagree
7-29-2021 17:59:12	Britto J	Egsspec	Strongly disagree	Agree	Agree	Agree	Agree	Agree
7-26-2021 16:53:51	Bharath P	Egsspec	Strongly disagree	Strongly disagree	Strongly disagree	Strongly disagree	Strongly disagree	Strongly disagree
7-26-2021 16:53:53	Balasubramani V	Egsspec	Agree	Strongly disagree	Strongly disagree	Strongly disagree	Strongly disagree	Strongly disagree
7-26-2021 16:53:51	Arjunan A	Egsspec	Neutral	Neutral	Neutral	Neutral	Neutral	Neutral
7-26-2021 16:53:53	Anand Kumar Varma S	Egsspec	Strongly agree	Strongly agree	Strongly agree	Strongly agree	Strongly agree	Strongly agree
7-26-2021 16:55:52	Athavanathan T	Egsspec	Agree	Agree	Agree	Agree	Agree	Agree

ATTESTED
Dr. S. RAMABALAN, M.E., Ph.D.,
PRINCIPAL
E.G.S. Pillay Engineering College,
Thethi, Nagore - 611 002.
Nagapattinam (Dt) Tamil Nadu.



E.G.S.Pillay Engineering College (Autonomous)

Certificate

This is to certify that **Dr.B.Vinodhkumar, Associate Professor, Civil Engineering** from **E.G.S.Pillay Engineering College** has attended the National level webinar on “**Climate Change and their Impacts**” organized by Department of Civil Engineering, **E.G.S.Pillay Engineering College (Autonomous), Nagapattinam** on **18th November 2020**.

Coordinator

HOD

Principal

ATTESTED

Dr. S. RAMABALAN, M.E., Ph.D.,
PRINCIPAL

E.G.S. Pillay Engineering College,
Thethi, Nagore - 611 002.
Nagapattinam (Dt) Tamil Nadu.



E.G.S.Pillay Engineering College (Autonomous)

Certificate

This is to certify that Mr.G.Prakash, Assistant Professor, Civil Engineering from E.G.S.Pillay Engineering College has attended the National level webinar on "Climate Change and their Impacts" organized by Department of Civil Engineering, E.G.S.Pillay Engineering College (Autonomous), Nagapattinam on 18th November 2020.

Coordinator

HOD

Principal

ATTESTED

Dr. S. RAMABALAN, M.E., Ph.D.,
PRINCIPAL

E.G.S. Pillay Engineering College,
Thethi, Nagore - 611 002.
Nagapattinam (Dt) Tamil Nadu.



E.G.S.Pillay Engineering College (Autonomous)

Certificate

This is to certify that **Mr.A.Pirakasam**, Assistant Professor, **Civil Engineering** from **E.G.S.Pillay Engineering College** has attended the **National level webinar on "Climate Change and their Impacts"** organized by Department of Civil Engineering, **E.G.S.Pillay Engineering College (Autonomous)**, Nagapattinam on **18th November 2020**.

Coordinator

HOD

Principal

ATTESTED

Dr. S. RAMABALAN, M.E., Ph.D.,
PRINCIPAL

E.G.S. Pillay Engineering College,
Thethi, Nagore - 611 002.
Nagapattinam (Dt) Tamil Nadu.



E.G.S. PILLAY ENGINEERING COLLEGE, NAGAPATTINAM

(An Autonomous Institution)

Affiliated to Anna University, Chennai | Approved by AICTE, New Delhi
Accredited by NAAC with "A" Grade | An ISO 9001:2015 Certified Institution

25
YEARS OF
EXCELLENCE



A REPORT ON ONE WORKSHOP

ON

ONLINE GUEST LECTURE

Organized

by

Department of Electronics and
communication Engineering

26 FEBURARY 2021

Time: 10.00 AM – 4.00 PM

ATTESTED

Dr. S. RAMABALAN, M.E., Ph.D.,
PRINCIPAL
E.G.S. Pillay Engineering College,
Thethi, Nagore - 611 002,
Nagapattinam (Dt) Tamil Nadu.

E.G.S.PILLAY ENGINEERING COLLEGE, NAGAPATTINAM

DEPARTMENT OF BIOMEDICAL ENGINEERING

A REPORT ON ONE DAY WORKSHOP

ON

FDP

TABLE OF CONTENTS

S.NO	PARTICULARS
1.	Certificates
2.	Photos

ATTESTED

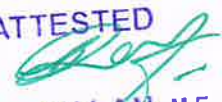
Dr. S. RAMABALAN, M.E., Ph.D.,
PRINCIPAL
E.G.S. Pillay Engineering College,
Thethi, Nagore - 611 002.
Nagapattinam (Dt) Tamil Nadu.



E.G.S. PILLAY

Autonomous
Old Nagore Road, Nagapattinam-611 002, Tamilnadu



Affiliated to Anna University | Approved by AICTE | Accredited by - NBA & MAAC 'A' Grade | Recognised by UGC 2(F) & 12(B) | An ISO 9001:2015 Certified Institution

Counselling Code : 3806

+91-4365-251112/14 | principal@egspec.org/enquires@egspec.org

Department of Electronics and Communication Engineering CERTIFICATE OF PARTICIPATION

This is to certify that

A. Arunya

E18ECR009

from

E.G.S PILLAY ENGINEERING COLLEGE(AUTONOMOUS)

has participated in the Online Guest Lecture delivered by Mr. D.Sathish Kumar, IT administrator, Saudi Arabia, on the topic "VoIP communication Technologies Unified Systems" on 26th of December 2021.

Dr. D. Devarajan,
Associate. Prof/ECE/Coordinator AP/ECE/Coordinator

Ms. S. Aadhira
AP/ECE/Coordinator

Dr. B. Padmanaban,
Prof & Head/ECE/Convenor

Dr. S. Ramabalan,
Principal, EGSPEC

Dr. S. RAMABALAN, M.E., Ph.D.,
PRINCIPAL

E.G.S. Pillay Engineering College,
Thethi, Nagore - 611 002,
Nagapattinam (Dt) Tamil Nadu.

21-22



E.G.S. PILLAY

AUTONOMOUS

Engineering College Old Nagore Road, Nagapattinam-611 002, Tamilnadu



Affiliated to Anna University | Approved by AICTE | Accredited by - NBA & NAAC 'A' Grade | Recognised by UGC 2(f) & 12(B) | An ISO 9001:2015 Certified Institution

Counselling Code : 3806

+91-4365-251112/14 | principal@egspec.org/enquires@egspec.org

Department of Electronics and Communication Engineering

CERTIFICATE OF PARTICIPATION

This is to certify that

A.GANESHA MOORTHY

E19ECCR028

from

E.G.S PILLAY ENGINEERING COLLEGE(AUTONOMOUS)

has participated in the Online Guest Lecture delivered by Mr. D.Sathish Kumar, IT administrator, Saudi Arabia, on the topic "VoIP communication Technologies Unified Systems" on 26th of December 2021.

Dr D. Devarajan,

Associate.Prof/ECE/Coordinator AP/ECE/Coordinator

Ms. S. Aadhirai

AP/ECE/Coordinator

Dr. B. Padmanaban,

Prof & Head/ECE/Convenor

ATTESTED

Dr. S. Ramabalan,

Dr. S. RAMABALAN@SPEC

PRINCIPAL

E.G.S. Pillay Engineering College,

Thechi, Nagore - 611 002.

Nagapattinam (Dt) Tamil Nadu.

REC **Dr. Deva Rajan is presenting**

A	N	
AADHIRAJ S	NIRAMATHI VEER...	Aa Sudhan
	A	
Abinaya Arasu	ABINAYAK E19EC...	sathish kumar
Janani G	10 others	You







3:00 PM | IP Telephony - Guest lecture

ATTESTED

**Dr. S. RAMABALAN, M.E., Ph.D.,
PRINCIPAL**
E.G.S. Pillay Engineering College,
Thethi, Nagore - 611 002.
Nagapattinam (Dt) Tamil Nadu.

VoIP Communication Technologies Unified Systems YEASTAR & YEALINK

D. SATHISH KUMAR M.E.,
IT Administrator
Technology Skills Telecom and InfoTech
Dammam, Kingdom of Saudi Arabia
<https://www.tecskills.net>

 sathish kumar	 Dr. Deva Rajan	 ANANDHARAJ
 satheswaran Sath...	 Ragu Bai	 Nishamoni Nisha...
 Gobi Ansu	 28 others	 You

ATTESTED



**Dr. S. RAMABALAN, M.E., Ph.D.,
PRINCIPAL
E.G.S. Pillay Engineering College,
Thethi, Nagore - 611 002.
Nagapattinam (Dt) Tamil Nadu.**



E.G.S. PILLAY ENGINEERING COLLEGE, NAGAPATTINAM

(An Autonomous Institution)

**Affiliated to Anna University, Chennai | Approved by AICTE, New Delhi
Accredited by NAAC with "A" Grade | An ISO 9001:2015 Certified Institution**

25
YEARS OF
EXCELLENCE



A REPORT ON ONE WORKSHOP

ON

DEEP DIVE INTO EMBEDDED INTERFACES

Organized

by

**Department of Electronics and
communication Engineering**

05-06-2021 & 06-06-2021

Time: 10.00 AM – 4.00 PM

ATTESTED

**Dr. S. RAMABALAN, M.E., Ph.D.,
PRINCIPAL**
**E.G.S. Pillay Engineering College,
Thethi, Nagore - 611 002,
Nagapattinam (Dt) Tamil Nadu.**

E.G.S.PILLAY ENGINEERING COLLEGE, NAGAPATTINAM

DEPARTMENT OF BIOMEDICAL ENGINEERING

A REPORT ON ONE DAY WORKSHOP

ON

FDP

TABLE OF CONTENTS

S.NO	PARTICULARS
1.	Report
2.	Approval letter to Principal
3.	Circular
4.	Attendance
5.	Photos
6.	Certificates
7.	Feedback forms from participants

ATTESTED

Dr. S. RAMABALAN, M.E., Ph.D.,
PRINCIPAL
E.G.S. Pillay Engineering College,
Thethi, Nagore - 611 002.
Nagapattinam (Dt) Tamil Nadu.



E.G.S. Pillay Engineering College (Autonomous)
Nagapattinam-611 002, Tamil nadu, India

(Accredited by NBA & NAAC, An ISO 9001-2015
Certified Institution, Affiliated to Anna University, Chennai, Tamil nadu, India)



DEPARTMENT OF ELECTRONICS AND COMMUNICATION ENGINEERING

IETE SPONSERED TWO DAYS WEBINAR WORKSHOP ON

“DEEP DIVE INTO EMBEDDED INTERFACES”

On

5.6.2021 & 6.6.2021

REPORT

Two Days Webinar workshop Programme in “Deep dive into embedded interfaces”, has been conducted in Online mode , organized by Department of Electronics and Communication Engineering sponsored by IETE Student Chapter, E.G.S. Pillay Engineering College, Nagapattinam. The Programme was inaugurated in the fine morning on 05th June 2021.

The one of the co-ordinator **Dr.D.Devarajan**, started this course with his welcome address. Head of the department **Dr.B.Padmanaban** gave the keynote address. Our esteemed Principal **Dr.S.Ramabalan** presented the inaugural address and Our one of resource person **Mr.VIGNESH.N, Lead-Firmware Application Engineer, Analog Devices INC, Bengaluru**, has explicated about ARM Microcontroller Architecture, Peripherals usages, GPIO Protocol, UART Protocol. Another resource person **Mr. SELVAKUMAR. S, Validation Engineer, Qualcomm Pvt Ltd, Bengaluru** has very deeply explained about I2C Protocol, SPI Protocol, USB Protocols, Totally 140 Participants were participated from Various Institutions across India.

Finally, on 06th June 2021 Programme came to a close, with the summary of the whole programme was given by Mr. **S.K.Paragadesh AP/ECE**, Coordinator proposed vote of thanks.

Dr. S. RAMABALAN, M.E., Ph.D.,
PRINCIPAL
E.G.S. Pillay Engineering College,
Thethi, Nagore - 611 002.
Nagapattinam (Dt) Tamil Nadu.

IETE SPONSERED TWO DAYS WEBINAR
WORKSHOP ON

"DEEP DIVE INTO EMBEDDED
INTERFACES"

REGISTRATION LINK:
<https://event.webinarjam.com/register/8217wz86ukr>

Or

<https://tinyurl.com/cccgspec-ddci>

REGISTRATION FEES: FREE

LAST DATE FOR REGISTRATION:
04.06.2021

Convener:

Dr. B. Padmanaban,
Professor & HOD/ECE

Coordinators:

Dr. D. Devarajan,
Associate Professor /ECE
(Email ID: devarajan@egspec.org
Contact number: 9894055342)

Mr. S. K. Pragadesh,
Assistant Professor/ECE
(Email ID: skpragadesh@egspec.org
Contact number: 9843356131)



**E.G.S. Pillay Engineering
College (Autonomous)
Nagapattinam-611 002.
Tamil nadu, India**

(Accredited by NBA & NAAC. An ISO 9001:2015
Certified Institution. Affiliated to Anna University,
Chennai, Tamil nadu, India)

DEPARTMENT OF ELECTRONICS
AND COMMUNICATION
ENGINEERING

Organizer

IETE SPONSERED TWO DAYS
WEBINAR WORKSHOP ON

"DEEP DIVE INTO
EMBEDDED
INTERFACES"

on

5th JUNE, 2021 & 6th JUNE 2021

RESOURCE PERSONS:

Mr. VIGNESH. N
Lead-Firmware Application Engineer
Analog Devices INC, Bengaluru,
Karnataka

Mr. SELVAKUMAR. S
Validation Engineer,
Qualcomm Pvt Ltd, Bengaluru,
Karnataka

SESSIONS AND TOPICS:

**Day 1: Date: 05.06.2021,
Time: 10:30 AM**

1. ARM Microcontroller Architecture
2. Understanding Protocol / Peripherals usages
3. GPIO Protocol
4. UART Protocol

**Day 2: Date: 06.06.2021,
Time: 10:30 AM**

5. I2C Protocol
6. SPI Protocol
7. USB Protocol
8. Final Exam

MEDIUM: Webinarjam.

Easy to access: No application required just touch the registration link.
All the participants are requested to login 5 minutes before the start of the session with muted video and audio.

ELIGIBILITY:

This Program is open to all UG, PG students, Faculty members and Research scholars.

E-CERTIFICATES:

E-Certificates will be provided to all the active participants based on attendance and the performance at final exam.

ABOUT THE PROGRAM:

The main objective of the program is to demonstrate the use of embedded protocols and designing applications using it. In the present world, digital technologies rule the world. The increase in the number of processors and communication options in a system is often driven by computation and I/O growth. Whenever there are external devices or more than one CPU in a system there must be some means of communication to coordinate action. In order to communicate within systems, devices use protocols. In this webinar, there will be clear demonstration on UART (Universal Asynchronous Receiver-Transmitter), I2C (Inter-Integrated Circuit), SPI (Serial Peripheral Interface), USB (Universal Serial Bus) protocols and how it can be effectively utilized with

peripherals and ARM micro controller M4 with General Purpose Input/Output.

The Arm Cortex-M4 processor is a highly-efficient embedded processor. The Cortex-M4 processor is developed to address digital signal control markets that demand an efficient, easy-to-use blend of control and signal processing capabilities. The combination of high-efficiency signal processing functionality with the low-power, low cost and ease-of-use benefits of the Cortex-M family of processors satisfies many markets. These industries include motor control, automotive, power management, embedded audio and industrial automation markets.

ABOUT THE COLLEGE:



E.G.S. Pillay Engineering College is a self-financing educational institution situated in Nagapattinam, Nagapattinam District. EGSPEC is the vision of Chevalier Dr. G.S. Pillay, whose determination and dynamism made possible the realization of this institution of excellence. Established in the year 1995 with 3 courses CSE, Mechanical and Chemical, affiliated to Bharathidasan University (First in Nagapattinam district). Established by the G.S. Pillay & Sons

Charitable and Educational Trust, Nagapattinam, Affiliated to Anna University, Chennai in the year 2002. UGC recognized institution under 2(B) and 12(B).

Recognized Research Centre for Mechanical Engineering by Anna University, Nodal Centre for QIC of Anna University, Chennai. Associate Member of ICTACT, Govt. of Tamil Nadu for Industry Institute Interaction.

ABOUT THE DEPARTMENT:

The Department of Electronics and Communication Engineering was started in the year 2004 with an intake of 30 students. In the Year 2006 the intake was increased to 60, subsequently to 120 in 2013 and also the post graduate program in Communication Systems with an intake of 18 was started in 2013. The department is recognized as a Research Centre under Anna University, Chennai in the year 2015 and in the same year, permanent affiliation was granted. Autonomous status approved in the year 2017.

Our Department is accredited by NAAC with A grade and NBA.

Our Department labs are well equipped with Anna University requirements and also additional research equipments like Campus Wide Matlab License, LabVIEW, Mentor Graphics, Vivado, Xilinx, SPICE, Python, ORCAD, TinkerCAD, OCTAVE, etc. the department has a team of Well Qualified and committed faculty members with diverse knowledge and experience in research and industry.

ATTESTED

**Dr. S. RAMABALAN, M.E., Ph.D.,
PRINCIPAL
E.G.S. Pillay Engineering College,
Thethi, Nagore - 611 002.
Nagapattinam (Dt) Tamil Nadu.**

RESOURCE PERSONS DETAILS

1. Mr. N. VIGNESH ,
Lead-Firmware Application Engineer,
Analog Devices INC,
Bengaluru,Karuataka.



- working as Lead firnware application engineer in Analog devices INC,Blore.
- Around 9+ years of experience in Research and Development of Semiconductor and Consumer electronics. Work experience from Microchip Technology, Danfoss Industry.
- Specialized Expert in Microcontroller, Microprocessor, SOC and ASIC firmware design and development Technologies.
- Experience in Bare Metal Firmware, RTOS, Middleware, BSP, Board bring-up, Embedded Protocols and diagnostics development.

2. Mr. S.SELVAKUMAR,
Validation Engineer,
Qualcomm Pvt Ltd,
Bengaluru, Karnataka.



- working as Validation engineer in Qualcomm Pvt Ltd, Blore.
- Having 4+ years of experience in Semiconductor Industry of Microchip Technology, Infineon Technologies, and ASIC and SoC Validation.
- Expertise in Pre-silicon & Post-silicon validation, test firmware development and Silicon development cycle.
- Very vast knowledge on Automotive Microcontrollers, FPGA based emulation platform and Embedded Hardware Design and Validation.

Participants responses on Test and Feedback in Google form

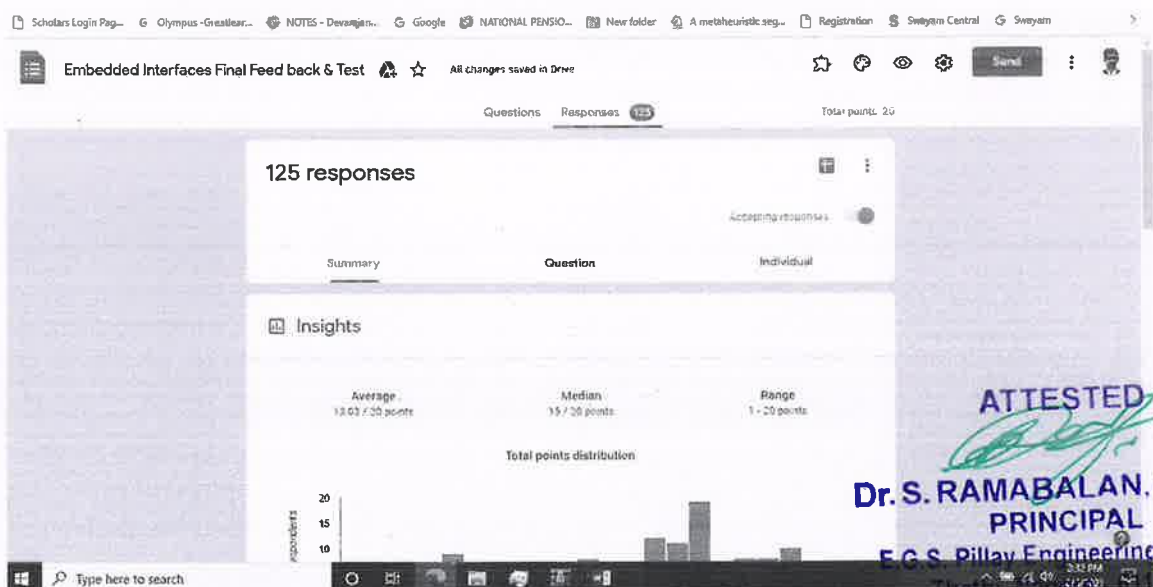

ATTESTED

Dr. S. RAMABALAN, M.E., Ph.D.
PRINCIPAL
E. G. S. Pillay Engineering College,
Thettni, Nagapattinam - 605 002.
Nagapattinam (Dt) Tamil Nadu.

Sample Certificate



Department of Electronics and Communication Engineering

CERTIFICATE OF PARTICIPATION



This is to certify that

Ms S. VASUNDARAA

E18ECR059

from

E. G. S. PILLAY ENGINEERING COLLEGE

has participated in the IETE sponsored WEBINAR WORKSHOP on "DEEP DIVE INTO EMBEDDED INTERFACES" on 5th and 6th of JUNE 2021 with score 16 / 20.



Mr.S.K.Pragadesh
AP/ECE/Coordinator

Dr D.Devarajan,
Associate.Prof/ECE/Coordinator

Dr B.Padmanaban,
Prof & Head/ECE / Convenor

Dr. S. Ramabalan,
Principal, EGSPEC

Coordinators
(Dr.D.Devarajan)
(S.K.Pragadesh)

HoD
(Dr. B. Padmanaban)

ATTESTED

Dr. S. RAMABALAN, M.E., Ph.D.,
PRINCIPAL
E.G.S. Pillay Engineering College,
Thethi, Nagore - 611 002
Nagapattinam (Dt) Tamil Nadu.

25.05.2021

From

Dr.D.Devarajan, Associate Professor,
S.K.Pragadesh, Assistant Professor,
Department of ECE,
E.G.S. Pillay Engineering College,
Nagapattinam.

To

The Principal,
E.G.S. Pillay Engineering College,
Nagapattinam.

Respected Sir,

Sub: Requisition to conduct one day webinar – Reg.

We planned to conduct one day technical seminar on “**Two Days Webinar on Deep dive into Embedded Interfaces**” sponsored by **Institution of Electronics and Telecommunication Engineers (IETE)** for final ECE students dated on 05.06.2021 & 06.06.2021. So, we request you to give the permission for this.

Thanking you,

Your's Faithfully

(D.Devarajan)

(S.K.Pragadesh)

Date: 25.05.2021

Place: EGSPEC, Nagapattinam

ATTESTED

Dr. S. RAMABALAN, M.E., Ph.D.,
PRINCIPAL
E.G.S. Pillay Engineering College,
Thethi, Nagore - 611 002.
Nagapattinam (Dt) Tamil Nadu.

28.05.2021

From

Dr.D.Devarajan, Associate Professor,
S.K.Pragadesh, Assistant Professor,
Department of ECE,
E.G.S. Pillay Engineering College,
Nagapattinam.

To

The Principal,
E.G.S. Pillay Engineering College,
Nagapattinam.

Respected Sir,

Sub: Requisition for Budget to conduct one day webinar – Reg.

We planned to conduct one day technical seminar on “**Two Days Webinar on Deep dive into Embedded Interfaces**” sponsored by **Institution of Electronics and Telecommunication Engineers (IETE)** for final ECE students dated on 05.06.2021 & 06.06.2021. Approximation budget for this seminar is enclosed with this letter. We request you to kindly do the needful

Thanking you,

Your's Faithfully

(D.Devarajan)

(S.K.Pragadesh)

Date: 28.05.2021

Place: EGSPEC, Nagapattinam

ATTESTED

Dr. S. RAMABALAN, M.E., Ph.D.,
PRINCIPAL
E.G.S. Pillay Engineering College,
Thethi, Nagore - 611 002.
Nagapattinam (Dt) Tamil Nadu.

31.05.2021

From

Dr. B. Padmanaban,
Head of the department,
Department of ECE,
E.G.S. Pillay Engineering College,
Nagapattinam.

To

The Project Manager,
Analog devices Inc ,
Bangalore.

Respected Sir ,

Sub: Requisition to depute **“Mr.N.VIGNESH, Lead-Firmware Application Engineer ”** for **IETE sponsored Two days webinar – Reg.**

Respected Sir,

I am very glad to share that, we are going to organize IETE sponsored Two days technical webinar on **“Deep dive into Embedded Interfaces”** which is scheduled on 05.06.2021 & 06.06.2021. In connection with this, it will be a great pleasure for us to depute **“Mr.N.VIGNESH, Lead-Firmware Application Engineer”** to address the title on “Embedded Interfaces.

Thanking you,

Your's Faitfully

(Dr. B. Padmanaban)

Date: 31.05.2021

Place: EGSPEC, Nagapattinam

ATTESTED

Dr. S. RAMABALAN, M.E., Ph.D.,
PRINCIPAL
E.G.S. Pillay Engineering College,
Thethi, Nagore - 611 002.
Nagapattinam (Dt) Tamil Nadu.

31.05.2021

From

Dr. B. Padmanaban,
Head of the department,
Department of ECE,
E.G.S. Pillay Engineering College,
Nagapattinam.

To

The Divisional Manager,
Qualcomm Pvt Ltd ,
Bangalore.

Respected Sir ,

Sub: Requisition to depute "**Mr. S.SELVAKUMAR, Validation Engineer, Qualcomm Pvt Ltd**" for **IETE sponsored Two days webinar – Reg.**

Respected Sir,

I am very glad to share that, we are going to organize **IETE** sponsored Two days technical webinar on "**Deep dive into Embedded Interfaces**" which is scheduled on 05.06.2021 & 06.06.2021. In connection with this, it will be a great pleasure for us to depute "**Mr. S.SELVAKUMAR, Validation Engineer**" to address the title on "Embedded Interfaces.

Thanking you,

Your's Faithfully

(**Dr. B. Padmanaban**)

Date: 31.05.2021

Place: EGSPEC, Nagapattinam

ATTESTED

Dr. S. RAMABALAN, M.E., Ph.D.,
PRINCIPAL
E.G.S. Pillay Engineering College,
Thethi, Nagore - 611 002.
Nagapattinam (Dt) Tamil Nadu.

01.06.2021

From

Mr.N.Vignesh,
Lead-Firmware Application Engineer,
Analog Devices INC,
Bangalore.

To

Dr. B. Padmanaban,
Head of the department,
Department of ECE,
E.G.S. Pillay Engineering College,
Nagapattinam.

Respected Sir,

Sub: Acceptance of resource person - **IETE sponsored Two days webinar – Reg.**

Respected Sir,

I am very happy to see your letter about to deliver a lecture on “Deep dive into Embedded Interfaces” as a resource person to your students. My project team leader gave permission to me for this webinar. From this letter I confirm my present in online on 05.06.2021 & 06.06.2021.

Thanking you,

Your's Faithfully

(N.Vignesh)

Date: 01.06.2021,

Place: Bangalore.

ATTESTED



**Dr. S. RAMABALAN, M.E., Ph.D.,
PRINCIPAL**

**E.G.S. Pillay Engineering College,
Thethi, Nagore - 611 002.
Nagapattinam (Dt) Tamil Nadu.**

01.06.2021

From

Mr.S.Selvakumar,
Validation Engineer,
Qualcomm Pvt Ltd,
Bangalore.

To

Dr. B. Padmanaban,
Head of the department,
Department of ECE,
E.G.S. Pillay Engineering College,
Nagapattinam.

Respected Sir,

Sub: Acceptance of resource person - **IETE sponsored Two days webinar – Reg.**

Respected Sir,

I am very happy to see your letter about to deliver a lecture on “Deep dive into Embedded Interfaces” as a resource person to your students. My project team leader gave permission to me for this webinar. From this letter I confirm my present in online on 05.06.2021 & 06.06.2021.

Thanking you,

Your's Faithfully

(S.Selvakumar)

Date: 01.06.2021,

Place: Bangalore.

ATTESTED

Dr. S. RAMABALAN, M.E., Ph.D.,
PRINCIPAL
E.G.S. Pillay Engineering College,
Thethi, Nagore - 611 002.
Nagapattinam (Dt) Tamil Nadu.

THE SECRETARY, PRINCIPAL, DEAN, HEADS, FACULTY MEMBERS &
STUDENTS ARE CORDIALLY INVITES YOU TO



INSTITUTION OF ELECTRONICS AND TELECOMMUNICATION ENGINEERS (IETE)



Sponsored

TWO DAYS WEBINAR

on

DEEP DIVE INTO EMBEDDED INTERFACES

(05.06.2021 & 06.06.2021)

Date: 05/06/2021 @ 10.30AM

Venue: Google meet (Online)

CHIEF GUESTS

Mr.N.Vignesh,

Lead-Firmware Application Engineer,

Analog Devices INC,
Bangalore.

Mr.S.Selvakumar,

Validation Engineer,

Qualcomm Pvt Ltd,
Bangalore.

Smt. S. Jothimani G.S. Pillay
Chairman – E.G.S. Pillay Group of Institutions

Chev. Dr. S. Paramesvaran
Secretary - E.G.S. Pillay Group of Institutions

Dr. S. Ramabalan
Principal, E.G.S. Pillay Engineering College

Dr. B. Padmanaban
HoD - ECE, E.G.S. Pillay Engineering College

Dr.D.Devarajan
ASP - ECE, E.G.S. Pillay Engineering College

Mr. S.K.Pragadesh
AP - ECE, E.G.S. Pillay Engineering College

Organized by
Department of Electronics and
Communication Engineering

E.G.S. PILLAY ENGINEERING COLLEGE (AUTONOMOUS)

NAGAPATTINAM – 611 002

(Approved by AICTE, New Delhi | Affiliated to Anna University, Chennai | NBA Accredited Program (EES, CSE and Mech) | Accredited by NAAC with 'A' Grade | Recognized by DSIR | An ISO 9001:2015 Certified Institution)

Dr. S. RAMABALAN, M.E., Ph.D.,
PRINCIPAL

E.G.S. Pillay Engineering College,
Thethi, Nagore - 611 002.
Nagapattinam (Dt) Tamil Nadu.

AGENDA

- Welcome Address : Dr. B. Padmanabhan, HOD – ECE
- Introducing Chief Guest : Dr. D.Devarajan, ASP - ECE
- Special address : Dr. S. Ramabalan – Principal
- Felicitatation address : Mr.S.K.Pragadesh, AP - ECE
- Keynote Presentation
by Chief Guest : Mr.N.Vignesh, Lead-Firmware Application Engineer,
Analog Devices INC, Bengaluru

SESSION DETAILS

Date	Expert Details	Lecture title
05.06.2021	Mr.N.Vignesh, Lead-Firmware Application Engineer, Analog Devices INC, Bengaluru	ARM Microcontroller Architecture, Peripherals usages, GPIO Protocol & UART Protocol
06.06.2021	Mr.S.Selvakumar, Validation Engineer, Qualcomm Pvt Ltd, Bengaluru	I2C Protocol, SPI Protocol & USB Protocols

Participants feedback collection

Vote of thanks : Mr. S.Aadhirai, AP - ECE



National Anthem

*You are
Cordially invited*

ATTESTED

[Signature]
Dr. S. RAMABALAN, Ph.D.,
PRINCIPAL

E.G.S. Pillay Engineering College,
Thethi, Nagore - 611 002.
Nagapattinam (Dt) Tamil Nadu.

	<p>E.G.S. PILLAY ENGINEERING COLLEGE (An Autonomous Institution, Affiliated to Anna University, Chennai) Nagore Post, Nagapattinam – 611 002, Tamilnadu. Department of Electronics and Communication Engineering</p>	
---	---	---

ECE/IETE/2021/ODD/CIRCULAR-01

DEPARTMENT CIRCULAR DATED 01.06.2021

To enhance the practical Skills to face Interview and Some Needed abilities of our ECE students, We are going to conduct the " Deep dive into Embedded interfaces " program on 05.06.2021 & 06.06.2021 through Google meet online mode.

OBJECTIVE

An effort to create awareness on Embedded interfaces. To enhance the practical Skills to face Interview and Some Needed abilities.

DAY	Participants	EVENT	RESOURCE PERSON
05.06.2021 & 06.06.2021	Various Academic students	<ul style="list-style-type: none"> • ARM Microcontroller Architecture • Peripherals usages • GPIO Protocols • UART Protocols • I2C Protocols • SPI Protocols • USB Protocols 	Mr.N.Vignesh, Lead-Firmware Application Engineer Analog Devices INC, Bengaluru & Mr.S.Selvakumar, Validation Engineer, Qualcomm Pvt Ltd, Bangalore

Program Co-ordinators

1. D.Devarajan
2. S.K.Pragadesh

HOD/ECE

Dr.B.Padmanaban

ATTESTED



**Dr. S. RAMABALAN, M.E., Ph.D.,
 PRINCIPAL
 E.G.S. Pillay Engineering College,
 Thethi, Nagore - 611 002.
 Nagapattinam (Dt) Tamil Nadu.**

Faculty	Signature	Faculty	Signature
Mr.K.Parthasarathi		Mr.S.JimHawkinson	
Mrs.R.S.Kotteshwari		Mr.S.Senthilkumar	
Mrs.S.Chitra		Mr.T.Senthilkumar	
Mrs.V.Elavarasi		Ms.D.Muthulakshmi	
Mr.D.Devarajan		Ms.S.Dhanalakshmi	
Mr.M.Nuthal Srinivasan		Ms.S.Aadhirai	
Mr.M.Irshad Ahamed			
Mr.L.Ramachandran		--	--

Laboratory Technician	Signature
Mr.K.Raju	
Mr. V.Karthikeyan	
Mrs.S.Keerthiga	
Mr.V.G.SudharasanaBaalajee	
Mr.B.NirmalDev	

ATTESTED

Dr. S. RAMABALAN, M.E., Ph.D.,
PRINCIPAL
E.G.S. Pillay Engineering College,
Thethi, Nagore - 611 002.
Nagapattinam (Dt) Tamil Nadu.



INSTITUTION OF ELECTRONICS AND TELECOMMUNICATION ENGINEERS (IETE)



Sponsored

TWO DAYS WEBINAR
on
DEEP DIVE INTO EMBEDDED INTERFACES
(05.06.2021 & 06.06.2021)

ORGANIZED BY

Department of Electronics and Communication Engineering
E.G.S. PILLAY ENGINEERING COLLEGE, NAGAPATTINAM
(AUTONOMOUS)

(Accredited by NAAC with 'A' grade || Recognized by DSIR || Recognized by UGC 2(f) & 12 (B)|| Provisional Accreditation in NBA for EEE, CSE and Mechanical || Approved by AICTE, New Delhi & Affiliated to Anna University, Chennai)

COMMITTEE LIST

Sl. No	Name of the Committee	Committee Representative	Student's Members	Responsibilities
1	Overall Program Coordination	Dr.D.Devarajan S.K.Pragadesh	KARTHIK RAJA V TAMILARASAN V	Invitation, Brochure, Report Preparation, Programme schedule and Overall Control
2	Comparing	S.Aadhirai, S.Chitra	SAROJINI. V PREETHI N	Comparing for Inauguration and Valediction, Chief Guest honour.
3	Registration	V.Elavarasi, S.Keerthiga	REVATHI N SUBASREE E	Registration, Attendance, Feedback & Certificate design.
4	PRO	M.Nuthal srinivasan, C.Matuvanesan	VANTHIYA DEVAN M VIGNESHWARAN K	Photo Session ,welcome

Coordinators
(Dr.D.Devarajan)
(S.K.Pragadesh)

HoD
(Dr. B.Padmanaban)

ATTESTED

Dr. S. RAMABALAN, M.E., Ph.D.,
PRINCIPAL
E.G.S. Pillay Engineering College,
Thethi, Nagore - 611 002.
Nagapattinam (Dt) Tamil Nadu.



INSTITUTION OF ELECTRONICS AND TELECOMMUNICATION ENGINEERS (IETE)



Sponsored

TWO DAYS WEBINAR
on
DEEP DIVE INTO EMBEDDED INTERFACES
(05.06.2021 & 06.06.2021)

ORGANIZED BY

Department of Electronics and Communication Engineering

E.G.S. PILLAY ENGINEERING COLLEGE, NAGAPATTINAM
(AUTONOMOUS)

(Accredited by NAAC with 'A' grade || Recognized by DSIR || Recognized by UGC 2(f) & 12 (B)|| Provisional Accreditation in NBA for EEE, CSE and Mechanical || Approved by AICTE, New Delhi & Affiliated to Anna University, Chennai)

PARTICIPATION NAME LIST

Sl.no	NAME OF PARTICIPANT	COLLEGE NAME
1	Mr. R. Muthu	EGS Pillay Engineering College, Nagapattiam.
2	Mr. Sugumaran V R	University College Of Engineering, Nagercoil
3	Mrs.K.Usha	E.G.S.P.E.C.Nagapattinam
4	Saravana G	King's College
5	Mrs.S.Chitra	EGS Pillay Engineering College, Nagapattiam.
6	Kecrthika V	Anjalai Ammal Mahalingam Engineering College
7	Bhuvanewari.G	Sri Manakukar Vinayagar Engineering College
8	V.Vinodhini	EGS Pillay Engineering College
9	Mr. R.Amaresh	EGS Pillay Engineering College
10	Mr. N. ARUNKUMAR	EGS Pillay Engineering College
11	Mr SELVAGANAPATHY.S	EGS PILLAY ENGINEERING COLLEGE
12	Dr.R.A.ABIRAMI	E.G.S PILLAY ENGINEERING COLLEGE
13	Keeerthika	Anjalai Ammal Mahalingam Engineering College
14	Prof.S.Jim Hawkinson	E.G.S.Pillay Engineering College (Autonomous)
15	Mr.Sivasakthivel.G	EGS PILLAY ENGINEERING COLLEGE
16	Mr. R. Sajithram	E. G. S. PILLAY ENGINEERING COLLEGE
17	Ms.Reshma Sasidaran	EGS Pillay Engineering College
18	Ms.Malarvizhi.A	EGS Pillay Engineering College
19	Ms S. VASUNDARAA	E. G. S. PILLAY ENGINEERING COLLEGE
20	Mr. SARABESHWARAN S	EGS PILLAY ENGINEERING COLLEGE
21	Mr. Akash S	EGS Pillay Engineering College
22	Miss M. Jai Shree	E. G. S. Pillay Engineering College
23	Subash.S	EGS Pillay Engineering College
24	Ms. Lavanya K	EGS Pillay Engineering College
25	Ms. AARTHI. B	EGS PILLAY ENGINEERING COLLEGE
26	M.Abarna	E.G.S.Pillay Engineering College
27	Mrs SEETHALAKSHMI	E.G.S PILLAY ENGINEERING COLLEGE
28	Mr.SAAJIDHULLAH I	E.G.S Pillay Engineering College
29	Mr.SYED ALI S	EGS Pillay Engineering College, Nagapattinam
30	Mr A. Prakash	E. G. S. PILLAY ENGINEERING COLLEGE
31	Dr. M. Irshad Ahamed	E.G.S. Pillay Engineering College
32	Mr.P.SIVANANTHAMOORTHI	EGS Pillay Engineering College, Nagapattiam.

ATTESTED

Dr. S. RAMABALAN, M.E., Ph.D.,
PRINCIPAL
E.G.S. Pillay Engineering College,
Thethi, Nagore - 611 002.
Nagapattinam (Dt) Tamil Nadu.

33	Mr.SAAJIDHULLAH I	E.G.S Pillay Engineering College
34	V.Abitha	Egs Pillay Engineering College
35	Mr.RIFAYUDEEN N	EGS PILLAY ENGINEERING COLLEGE
36	Mrs S.Malavika	E.G.S.Pillay Engineering College
37	Mr HARIRAMAPRASATH C R	E.G.S. PILLAY ENGINEERING COLLEGE
38	Swetha A	EGS Pillay Engineering College
39	Mr.Jaipoorana.S	E.G.S Pillay Engineering College
40	Mr S.Subalakshmi	Egs Pillay Engineering College
41	Mr SHANMUGARAJ T	Egs Pillay Engineering College
42	A. Arunya	E. G. S. Pillay Engineering College
43	K.Kamalavashini	E.G.S.Pillay Engineering College
44	Mr. G Thiyakesan	E.G.S.Pillay Engineering College
45	K.Keerthana	E.G.S.Pillay Engineering College
46	Vigneshwaran M J	Sri Ramakrishna Mission Vidyalyaya Polytechnic College
47	Mr. K. VIJAYAKUMAR	E. G. S. Pillay Engineering College
48	Mr. IYAPPAN A	Egs Pillay Engineering College
49	Surya Prakash .B	E.G.S Pillay Engineering College
50	Dr.S.M.Ramesh	Kpr Institute Of Engineering And Technology
51	Mr.Lokeswaran.S	E.G.S Pillay Engineering College
52	Mr Mohamed Sameer B	Egs Pillay Engineering College
53	E. Nanthan	E. G. S. Pillay Engineering College Nagapattinam
54	Mr. Boopathy	EGS PILLAY ENGINEERING COLLEGE
55	Mr RAMESH.S	EGS PILLAY ENGINEERING COLLEGE, NAGAPATTINAM.
56	Ms. ARTHI. S	EGS PILLAY ENGINEERING COLLEGE.
57	Mr.S.SARAVANAN	EGS PILLAY ENGINEERING COLLEGE
58	V.Subasri	E.G.S Pillay Engineering College
59	Ms.Atchaya	E.G.S.Pillay Engineering College
60	Mr.R. UDHAYA KUMAR	E.G.S Pillay Engineering College
61	Mr. JAYADEVAN N M	KARPAGAM COLLEGE OF ENGINEERING
62	Mr. S. Senthilkumar	E.G.S. Pillay Engineering College (Autonomous)
63	Mr.E .ASWATHAMAN	E.G.S Pillay Engineering College, Nagapattinam.
64	Mr.B.MAHENDRAN	E.G.S.PILLAY ENGINEERING COLLEGE
65	Priyadharshini.B	Egs Pillay Engineering College
66	Mr. R. Muthu	EGS Pillay Engineering College, Nagapattinam.
67	K Manivannan	E.G.S.Pillay Engineering College Nagapattinam
68	Ms.G.VINOTHINI	E.G.S PILLAY ENGINEERING COLLEGE
69	Mr V.Sophia	E.G.S Pillay Engineering College (Autonomous)
70	Ms.A.Abinaya	E. G. S. Pillay Engineering College
71	S.Familiarufi	Anjalai Ammal Mahalingam Engineering College
72	Mr.SELLAMUTHU M	E. G. S. Pillay Engineering College, Nagapattinam
73	Mr. Vijayakumar. B	E. G. S Pillay Engineering College
74	Rajesh T	Egs Pillay Engineering College
75	Ms.J.Suvedha	Sir Issac Newton College Of Engineering And Technology
76	Mrs. V. ELAVARASI	E.G.S PILLAY ENGINEERING COLLEGE(AUTONOMOUS)
77	Abinesh.M	EGS Pillay Engineering College
78	Mr S S VIKASH VIKNESH	EGS PILLAY ENGINEERING COLLEGE, NAGAPATTINAM
79	Kamalraj	Egs Pillay Engineering College
80	Mrs.R.AHILA	EGS Pillay Engineering College,Nagapattinam
81	Mr,B. Ragu	E,G,S Pillay Engineering College
82	Dr. GV. SHRICHANDRAN	SRMISR, RAMAPURAM, CHENNAI

ATTESTED

Dr. S. RAMABALAN, M.E., Ph.D.
PRINCIPAL

E.G.S. Pillay Engineering College,
Thethi, Nagore - 611 002.
Nagapattinam (Dt) Tamil Nadu.

83	Mr .ANANDHARAJ T	E.G.S. PILLAY ENGINEERING COLLEGE,NAGAPATTINAM
84	Mrs V.Nivetha	EGS Pillay Engineering College
85	Ms R.NIVASHINI	E.G.S.PILLAY ENGINEERING COLLEGE
86	Ms. SHAFRIN BEEVI	EGS PILLAY ENGINEERING COLLEGE
87	Mr. E.ARAVINDH	EGS. Pillay Engineering College
88	J.Rexy Jenifer	E.G.S Pillay Engineering College
89	Mr.SURESHRAJAN R	E.G.S PILLAY ENGINEERING COLLEGE
90	Ms.JANANI R	EGS Pillay Engineering College Nagapattinam
91	Mr.Mugesh.R	E.G.S Pillay Engineering College
92	Prof.S.Jim Hawkinson	E.G.S.Pillay Engineering College (Autonomous)
93	Mr.A.SUDHARSHAN	EGS PILLAY ENGINEERING College
94	Mrs.SWETHA.S	EGS PILLAY ENGINEERING COLLEGE NAGAPATTINAM
95	Mohamed Shagul Hameed T	E.G.S.Pillay Engineering College
96	Mr.SAAJIDHULLAH I	E.G.S Pillay Engineering College
97	S.Familiarufi	Anjalai Ammal Mahalingam Engineering College
98	Mr THARIQ	E.G.S.Pillay Engineering
99	Ms.Sivasukitha.S	E.G.S.Pillay Engineering College,Nagapattinam.
100	Sridevi.J	Egs Pillay Engineering College, Nagapattiam.
101	S. Sivakumar	Egs Pillay Engineering College, Nagapattiam.
102	Mrs. Abirami.K	EGS Pillay Engineering College, Nagapattiam.
103	Mr VIGNESH S	Sri Ramakrishna Mission Vidyalaya Polytechnic College
104	Akash.K	Anjalai Ammal Mahalingam Engineering College
105	Mr.Mani Rathnam.A	EGS Pillay Engineering College
106	Ms.Lingeshwari.V	E.G.S Pillay Engineering College
107	Mr.JAYADEVAN N M	KARPAGAM COLLEGE OF ENGINEERING
108	Mr. RAMGOPAL M	EGS Pillay Engineering College
109	Gnanaprakasam S	EGS Pillay Engineering College
110	Abinaya. K	EGS Pillay Engineering College
111	Dr.B.Gomathy	K.P.R Institute Of Engineering And Technology
112	Mr T.SENTHIL KUMAR	E.G.S PILLAY ENGINEERING COLLEGE(AUTONOMOUS)
113	Mr.B.JEGAN	E.G.S PILLAY POLYTECHNIC COLLEGE
114	Dr. Gv. Shrichandran	SRM Insitute of Science and technology, Ramapuram, Chennai
115	Ms.K.REVATHI	EGS Pillay Engineering College, Nagapattiam.
116	Ms. G. Janani	EGS PILLAY ENGINEERING COLLEGE
117	Mr. M. Nuthal Srinivasan	E.G.S.Pillay Engineering College

Coordinators
(D.Devarajan)
(S.K.Pragadesh)

HoD
(Dr. B. Padmanaban)

ATTESTED

Dr. S. RAMABALAN, M.E., Ph.D.,
PRINCIPAL
E.G.S. Pillay Engineering College,
Thethi, Nagore - 611 002.
Nagapattinam (Dt) Tamil Nadu.



INSTITUTION OF ELECTRONICS AND TELECOMMUNICATION ENGINEERS (IETE)



Sponsored

TWO DAYS WEBINAR
on
DEEP DIVE INTO EMBEDDED INTERFACES
(05.06.2021 & 06.06.2021)

ORGANIZED BY

Department of Electronics and Communication Engineering

E.G.S. PILLAY ENGINEERING COLLEGE, NAGAPATTINAM
(AUTONOMOUS)

(Accredited by NAAC with 'A' grade || Recognized by DSIR || Recognized by UGC 2(f) & 12 (B)|| Provisional Accreditation in NBA for EEE, CSE and Mechanical || Approved by AICTE, New Delhi & Affiliated to Anna University, Chennai)

S. No.	Reg. No.	Name	05.06.2021		06.06.2021		06.06.2021		06.06.2021		06.06.2021	
			FN	AN	FN	AN	FN	AN	FN	AN	FN	AN

Coordinators
(Dr.D.Devarajan)
(S.K.Pragadesh)

HoD
(Dr. B.Padmanaban)

ATTESTED

Dr. S. RAMABALAN, M.E., Ph.D.,
PRINCIPAL
E.G.S. Pillay Engineering College,
Thethi, Nagore - 611 002.
Nagapattinam (Dt) Tamil Nadu.



INSTITUTION OF ELECTRONICS AND TELECOMMUNICATION ENGINEERS (IETE)



Sponsored

*Two days webinar
On
DEEP DIVE INTO EMBEDDED INTERFACES
(05.06.2021 & 06.06.2021)*

Department of Electronics and Communication Engineering
E.G.S. PILLAY ENGINEERING COLLEGE, NAGAPATTINAM
(AUTONOMOUS)

(Accredited by NAAC with 'A' grade || Recognized by DSIR || Recognized by UGC 2(f) & 12 (B)|| Provisional Accreditation in NBA for EEE, CSE and Mechanical || Approved by AICTE, New Delhi & Affiliated to Anna University, Chennai)

Date: 08.06.2021

EXPENDITURE DETAILS

S.NO	PARTICULARS	AMOUNT SPENT (in Rs.)
01	Resource person honorarium	4,000/-
	TOTAL	4,000/-

Coordinators
(Dr.D.Devarajan)
(S.K.Pragadesh)

HoD
(Dr. B. Padmanaban)

ATTESTED

Dr. S. RAMABALAN, M.E., Ph.D.,
PRINCIPAL
E.G.S. Pillay Engineering College,
Thethi, Nagore - 611 002.
Nagapattinam (Dt) Tamil Nadu.

E.G.S. PILLAY ENGINEERING COLLEGE, NAGAPATTINAM.

SEMINAR EVALUATION FORM

Title of the seminar : Deep dive into embedded interfaces

Date : 05.06.2021 & 06.06.2021

Dept. Name: ECE

Coordinators Name : Dr.D.Devarajan & S.K.Pragadesh

Seminar type : Two days Webinar -Google meet (Online)

1. Seminar Contents

Please rate the sessions you attended by specifying the number using the scale: Excellent = 5, Very Good = 4, Good = 3, Average = 2, Poor = 1

Session No.	Speaker Name	Identified Topics	Duration of the session	Topic Coverage and Relevance	preparedness
Day 1 FN&AN	Mr.N.Vignesh, Lead-Firmware Application Engineer, Analog Devices INC, Bengaluru	ARM Microcontroller Architecture, Peripherals usages, GPIO Protocol & UART Protocol	FN&AN		
Day 2 FN&AN	Mr.S.Selvakumar, Validation Engineer, Qualcomm Pvt Ltd, Bengaluru	I2C Protocol, SPI Protocol & USB Protocols	FN&AN		

Please mention your favourite speaker at the seminar.....

2. Overall Organisation of the Seminar

Please rate the following aspects of the seminar organisation and administration

Excellent = 5, Very Good = 4, Good = 3, Average = 2, Poor = 1

Overall Content Identified/ Topics/ Duration of the session	5	4	3	2	1
Topic Coverage and Relevance	5	4	3	2	1
The objective of the seminar was well-defined	5	4	3	2	1
The quality of content was excellent	5	4	3	2	1
The content was pertaining to my expectation	5	4	3	2	1
Seminar materials & proceedings	5	4	3	2	1
Accommodation/ Catering	5	4	3	2	1

3. Overall Experience about the seminar

5 4 3 2 1

Excellent = 5, Very Good = 4, Good = 3, Average = 2, Poor = 1

To be on the mailing list for the future seminars. Please give us your contact details.

Name:

Signature:.....

Please hand over this completed form to the webinar coordinator on your departure.

EGSPEC Seminar – Evaluation form

ATTESTED



**Dr. S. RAMABALAN, M.E., Ph.D.,
PRINCIPAL**

**E.G.S. Pillay Engineering College,
Thethi, Nagore - 611 002.**

Nagapattinam (Dt) Tamil Nadu.



INSTITUTION OF ELECTRONICS AND TELECOMMUNICATION ENGINEERS (IETE)



Sponsored

**Two days webinar
On
DEEP DIVE INTO EMBEDDED INTERFACES
(05.06.2021 & 06.06.2021)**

ORGANIZED BY
Department of Electronics and Communication Engineering
E.G.S. PILLAY ENGINEERING COLLEGE, NAGAPATTINAM
(AUTONOMOUS)

(Accredited by NAAC with 'A' grade || Recognized by DSIR || Recognized by UGC 2(f) & 12 (B)|| Provisional Accreditation in NBA for EEE, CSE and Mechanical || Approved by AICTE, New Delhi & Affiliated to Anna University, Chennai)

Information from participants feedbacks are collectively listed below

1. The topic coverage and relevance of this seminar is very good. (Overall Rating 4)
2. The objective of the seminar is clearly defined. (Overall Rating 4)
3. The quality of delivered content is very good. (Overall Rating 4)
4. Seminar material is useful. (Overall Rating 3)
5. Refreshment is excellent. (Overall Rating 5)

Coordinators
(D.Devarajan)
(S.K.Pragadesh)

HoD
(Dr. B. Padmanaban)
ATTESTED

Dr. S. RAMABALAN, M.E., Ph.D.,
PRINCIPAL
E.G.S. Pillay Engineering College,
Thethi, Nagore - 611 002.
Nagapattinam (Dt) Tamil Nadu.



INSTITUTION OF ELECTRONICS AND TELECOMMUNICATION ENGINEERS (IETE)



Sponsored

**Two days webinar
On
DEEP DIVE INTO EMBEDDED INTERFACES
(05.06.2021 & 06.06.2021)**

ORGANIZED BY

**Department of Electronics and Communication Engineering
E.G.S. PILLAY ENGINEERING COLLEGE, NAGAPATTINAM
(AUTONOMOUS)**

(Accredited by NAAC with 'A' grade || Recognized by DSIR || Recognized by UGC 2(f) & 12 (B)|| Provisional Accreditation in NBA for EEE, CSE and Mechanical || Approved by AICTE, New Delhi & Affiliated to Anna University, Chennai)

MAPPING WITH PO's

PO→ Event↓	PO1	PO2	PO3	PO4	PO5	PO6	PO7	PO8	PO9	PO10	PO11	PO12	PSO1	PSO2
Deep Dive Into Embedded Interfaces	S	M	S	M	M	-	-	-	L	-	-	M	S	-

Program Specific Outcomes (PSO):

After successful completion of the programme, Graduates will be able to

PSO1: Have additional skills and knowledge to design, develop and implement Micro Electronics Applications and Embedded systems.

PSO2: Design systems to solve contemporary issues of modern communication systems, Advanced Networking and High Frequency RF applications.

Attainment Calculations:

Sl.no	Name Of Participant	Marks	Percentage
1	Mr. R. Muthu	5 / 20	25%
2	Mr. Sugumaran V R	5 / 20	25%
3	Mrs.K.Usha	5 / 20	25%
4	Saravana G	4 / 20	20%
5	Mrs.S.Chitra	2 / 20	10%
6	Keerthika V	4 / 20	20%
7	Bhuvaneswari.G	13 / 20	65%
8	V. Vinodhini	3 / 20	15%
9	Mr. R.Amaresh	4 / 20	20%
10	Mr. N. ARUNKUMAR	5 / 20	25%
11	Mr SELVAGANAPATHY.S	1 / 20	5%
12	Dr.R.A.ABIRAMI	1 / 20	5%

ATTESTED

**Dr. S. RAMABALAN, M.E., Ph.D.,
PRINCIPAL
E.G.S. Pillay Engineering College,
Thethi, Nagore - 611 002.
Nagapattinam (Dt) Tamil Nadu.**

13	Keerthika	16 / 20	80%
14	Prof.S.Jim Hawkinson	16 / 20	80%
15	Mr.Sivasakthivel.G	9 / 20	45%
16	Mr. R. Sajithram	5 / 20	25%
17	Ms.Reshma Sasidaran	20 / 20	100%
18	Ms.Malarvizhi.A	16 / 20	80%
19	Ms S. VASUNDARAA	15 / 20	75%
20	Mr. SARABESHWARAN S	16 / 20	80%
21	Mr. Akash S	14 / 20	70%
22	Miss M. Jai Shree	16 / 20	80%
23	Subash.S	2 / 20	10%
24	Ms. Lavanya K	3 / 20	15%
25	Ms. AARTHI. B	16 / 20	80%
26	M.Abarna	5 / 20	25%
27	Mrs SEETHALAKSHMI	15 / 20	75%
28	Mr.SAAJIDHULLAH I	14 / 20	70%
29	Mr.SYED ALI S	14 / 20	70%
30	Mr A. Prakash	14 / 20	70%
31	Dr. M. Irshad Ahamed	11 / 20	55%
32	Mr.P.SIVANANTHAMOORTHI	11 / 20	55%
33	Mr.SAAJIDHULLAH I	14 / 20	70%
34	V.Abitha	14 / 20	70%
35	Mr.RIFAYUDEEN N	6 / 20	30%
36	Mrs S.Malavika	11 / 20	55%
37	Mr HARIRAMAPRASATH C R	4 / 20	20%
38	Swetha A	16 / 20	80%
39	Mr.Jaipoorna.S	16 / 20	80%
40	Mr S.Subalakshmi	16 / 20	80%
41	Mr SHANMUGARAJ T	20 / 20	100%
42	A. Arunya	16 / 20	80%
43	K.Kamalavashini	9 / 20	45%
44	Mr. G Thiyakesan	15 / 20	75%
45	K.Keerthana	10 / 20	50%
46	Vigneshwaran M J	5 / 20	25%
47	Mr. K. VIJAYAKUMAR	15 / 20	75%
48	Mr. IYAPPAN A	18 / 20	90%
49	Surya Prakash .B	7 / 20	35%
50	Dr.S.M.Ramesh	12 / 20	60%
51	Mr.Lokeswaran.S	11 / 20	55%
52	Mr Mohamed Sameer B	16 / 20	80%
53	E. Nanthan	19 / 20	95%
54	Mr. Boopathy	15 / 20	75%
55	Mr RAMESH.S	13 / 20	65%
56	Ms. ARTHI. S	11 / 20	55%
57	Mr.S.SARAVANAN	3 / 20	15%
58	V.Subasri	13 / 20	65%
59	Ms.Atchaya	7 / 20	35%
60	Mr.R. UDHAYA KUMAR	17 / 20	85%
61	Mr. JAYADEVAN N M	14 / 20	70%
62	Mr. S. Senthikumar	14 / 20	70%
63	Mr.E .ASWATHAMAN	18 / 20	90%
64	Mr.B.MAHENDRAN	14 / 20	70%

ATTESTED



Dr. S. RAMABALAN, M.E., Ph.D.
PRINCIPAL
E.G.S. Pillay Engineering College.
Thethi, Nagore - 611 002.
Nagapattinam (Dt) Tamil Nadu.

65	Priyadharshini.B	11 / 20	55%
66	Mr. R. Muthu	20 / 20	100%
67	K Manivannan	14 / 20	70%
68	Ms.G.VINOTHINI	14 / 20	70%
69	Mr V.Sophia	17 / 20	85%
70	Ms.A.Abinaya	19 / 20	95%
71	S.Familiarufi	19 / 20	95%
72	Mr.SELLAMUTHU M	18 / 20	90%
73	Mr. Vijayakumar. B	12 / 20	60%
74	Rajesh T	15 / 20	75%
75	Ms.J.Suvedha	15 / 20	75%
76	Mrs. V. ELAVARASI	3 / 20	15%
77	Abinesh.M	11 / 20	55%
78	Mr S S VIKASH VIKNESH	5 / 20	25%
79	Kamalraj	14 / 20	70%
80	Mrs.R.AHILA	16 / 20	80%
81	Mr,B. Ragu	7 / 20	35%
82	Dr. GV. SHRICHANDRAN	16 / 20	80%
83	Mr .ANANDHARAJ T	10 / 20	50%
84	Mrs V.Nivetha	13 / 20	65%
85	Ms R.NIVASHINI	13 / 20	65%
86	Ms. SHAFRIN BEEVI	19 / 20	95%
87	Mr. E.ARAVINDH	16 / 20	80%
88	J.Rexy Jenifer	17 / 20	85%
89	Mr.SURESHRAJAN R	17 / 20	85%
90	Ms.JANANI R	18 / 20	90%
91	Mr.Mugesh.R	18 / 20	90%
92	Prof.S.Jim Hawkinson	16 / 20	80%
93	Mr.A.SUDHARSHAN	18 / 20	90%
94	Mrs.SWETHA.S	16 / 20	80%
95	Mohamed Shagui Hameed T	17 / 20	85%
96	Mr.SAAJIDHULLAH I	20 / 20	100%
97	S.Familiarufi	16 / 20	80%
98	Mr THARIQ	9 / 20	45%
99	Ms.Sivasukitha.S	16 / 20	80%
100	Sridevi.J	20 / 20	100%
101	S. Sivakumar	17 / 20	85%
102	Mrs. Abirami.K	10 / 20	50%
103	Mr VIGNESH S	15 / 20	75%
104	Akash.K	15 / 20	75%
105	Mr.Mani Rathnam.A	6 / 20	30%
106	Ms.Lingeshwari.V	12 / 20	60%
107	Mr.JAYADEVAN N M	15 / 20	75%
108	Mr. RAMGOPAL M	17 / 20	85%
109	Gnanaprakasam S	7 / 20	35%
110	Abinaya. K	18 / 20	90%
111	Dr.B.Gomathy	19 / 20	95%
112	Mr T.SENTHIL KUMAR	12 / 20	60%
113	Mr.B.JEGAN	11 / 20	55%
114	Dr. Gv. Shrichandran	15 / 20	75%
115	Ms.K.REVATHI	20 / 20	100%
116	Ms. G. Janani	19 / 20	95%

ATTESTED

Dr. S. RAMABALAN, M.E., Ph.D.,
PRINCIPAL
E.G.S. Pillay Engineering College,
Thethi. Nagore - 611 002.
Nagapattinam (Dt) Tamil Nadu.

117	Mr. M. Nuthal Srinivasan	19 / 20	95%
Average percentage			65%

Attainment Level 1: 60% – 69%

Attainment Level 2: 70% – 79%

Attainment Level 3: >=80%

Achieved attainment level is 1. (81%)

PO → Event ↓	PO1	PO2	PO3	PO4	PO5	PO6	PO7	PO8	PO9	PO10	PO11	PO12	PSO1	PSO2
Deep Dive Into Embedded Interfaces	3	2	3	2	2	-	-	-	1	-	-	2	3	-

Coordinators
(Dr.D.Devarajan)
(S.K.Pragadesh)

HoD
(Dr. B. Padmanaban)



INSTITUTION OF ELECTRONICS AND TELECOMMUNICATION ENGINEERS (IETE)



Sponsored

ONE DAY TECHNICAL SEMINAR
on
JOB Opportunities in Electronic core Sector
(18.08.2018)

ORGANIZED BY
Department of Electronics and Communication Engineering

ATTESTED

Dr. S. RAMABALAN, M.F. Ph.D.
PRINCIPAL
E.G.S. Pillay Engineering College,
Thethi, Nagore - 617 001
Nagapattinam (Dt) Tamil Nadu

**E.G.S. PILLAY ENGINEERING COLLEGE, NAGAPATTINAM
(AUTONOMOUS)**

(Accredited by NAAC with 'A' grade || Recognized by DSIR || Recognized by UGC 2(f) & 12 (B)|| Provisional Accreditation in NBA for EEE, CSE and Mechanical || Approved by AICTE, New Delhi & Affiliated to Anna University, Chennai)

Activity End Report:

1. Expected attainment level (3) of this activity is achieved.
2. Support of this activity to the relevant POs is in the expected level.
3. From the students feedback, this programme can be conducted for upcoming batch students.

**Coordinators
(D.Devarajan)
(L.Ramachandran)**

**HoD
(Dr. B. Padmanaban)**



INSTITUTION OF ELECTRONICS AND TELECOMMUNICATION ENGINEERS (IETE)



Sponsored

**ONE DAY TECHNICAL SEMINAR
on
JOB Opportunities in Electronic core Sector
(18.08.2018)**

**ORGANIZED BY
Department of Electronics and Communication Engineering**

ATTESTED

**Dr. S. RAMABALAN, M.E., Ph.D.,
PRINCIPAL
E.G.S. Pillay Engineering College,
Thethi. Nagore - 611 002
Nagapattinam (Dt) Tamil Nadu.**

**E.G.S. PILLAY ENGINEERING COLLEGE, NAGAPATTINAM
(AUTONOMOUS)**

(Accredited by NAAC with 'A' grade || Recognized by DSIR || Recognized by UGC 2(f) & 12 (B)|| Provisional Accreditation in NBA for EEE, CSE and Mechanical || Approved by AICTE, New Delhi & Affiliated to Anna University, Chennai)

TEST QUESTIONS

Each Question carry one mark

1

- Consider the given circuit in this , the race around
 (A) does not occur
 (B) occur when $CLK = 0$
 (C) occur when $CLK = 1$ and $A = B = 1$
 (D) occur when $CLK = 1$ and $A = B = 0$

The output Y in the circuit below is always '1' when

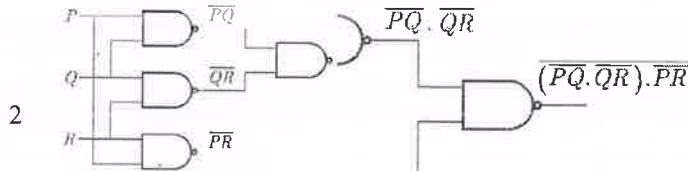

- (A) two or more of the inputs P, Q, R are '0'
 (B) two or more of the inputs P, Q, R are '1'
 (C) any odd number of the inputs P, Q, R is '0'
 (D) any odd number of the inputs P, Q, R is '1'
- 3 In the following figure, C1 and C2 are ideal capacitors. C1 has been charged to 12 V before the ideal switch S is closed at $t = 0$. The current $i(t)$ for all t is

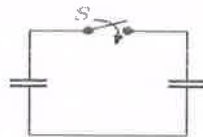

- (A) zero (B) a step function
 (C) an exponentially decaying function
 (D) an impulse function
- 4 The average power delivered to an impedance $(4 - j3) \Omega$ by a current $i(t) = 5 \cos(100\pi t + 100^\circ)$ A is
- (A) 44.2 W (B) 50 W (C) 62.5 W (D) 125 W

5

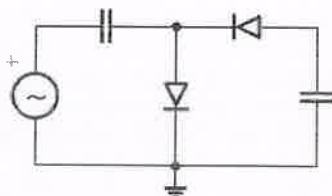

ATTESTED

**Dr. S. RAMABALAN, M.E., Ph.D.,
 PRINCIPAL
 E.G.S. Pillay Engineering College,
 Thethi, Nagore - 611 002.
 Nagapattinam (Dt) Tamil Nadu.**

The diodes and capacitors in the circuit shown are ideal. The voltage $v(t)$ across the diode D_1 is

- (A) $\cos(\omega t) - 1$ (B) $\sin(\omega t)$
 (C) $1 - \cos(\omega t)$ (D) $1 - \sin(\omega t)$

6 In the circuit shown, Implement Y,

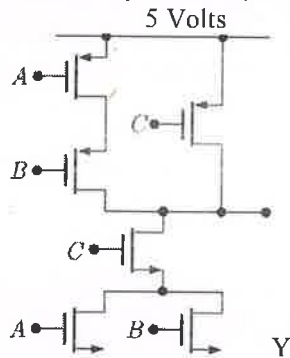

- (A) $Y = A B + C$
 (B) $Y = (A + B) C$
 (C) $Y = (A + B) C$
 (D) $Y = AB + C$

7 In the circuit shown below, capacitors C_1 and C_2 are very large and are shorts at the input frequency. v_i is a small signal input. The gain magnitude at 10 M rad/sec

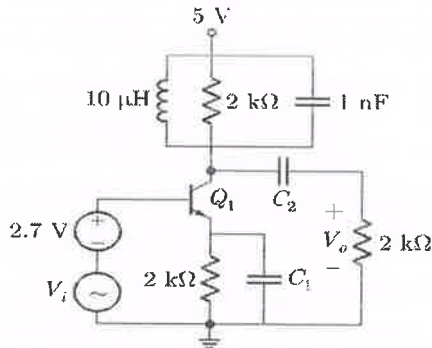

- (A) maximum (B) minimum
 (C) unity (D) zero

8 In the circuit shown below, the current through the inductor is

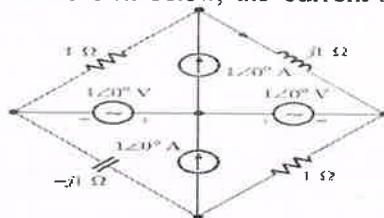

- (A) $(2/1+j)A$
 (B) $\frac{-1}{1+j}A$
 (C) $(1/1+j)A$
 (D) 0 A

ATTESTED

 Dr. S. RAMABALAN, M.E., Ph.D.,
 PRINCIPAL
 E.G.S. Pillay Engineering College,
 Thethi, Nagore - 611 002.
 Nagapattinam (Dt) Tamil Nadu.

- 9 The feedback system shown below oscillates at 2 rad/s when

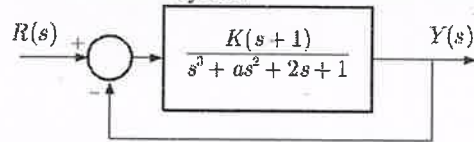

- (A) $K = 2$ and $a = 0.75$
 (B) $K = 4$ and $a = 0.5$.
 (C) $K = 3$ and $a = 0.75$
 (D) $K = 2$ and $a = 0.5$

- 10 In the silicon BJT circuit shown below, assume that the emitter area of transistor Q_1 is half that of transistor Q_2 .

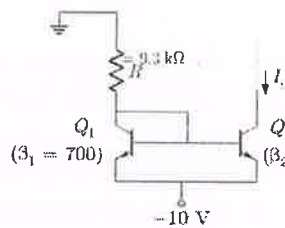

The value of current I_O is approximately

- (A) 0.5 mA (B) 2 ma
 (C) 9.3 mA (D) 15 ma

Coordinators
(D.Devarajan)
(L.Ramachandran)

HoD
(Dr. B. Padmanaban)

ATTESTED

Dr. S. RAMABALAN, M.E., Ph.D.,
PRINCIPAL

E.G.S. Pillay Engineering College,
Thethi, Nagore - 611 002.
Nagapattinam (Dt) Tamil Nadu.



INSTITUTION OF ELECTRONICS AND TELECOMMUNICATION ENGINEERS (IETE)



Sponsored

Two days webinar
On
DEEP DIVE INTO EMBEDDED INTERFACES
(05.06.2021 & 06.06.2021)

ORGANIZED BY
Department of Electronics and Communication Engineering
E.G.S. PILLAY ENGINEERING COLLEGE, NAGAPATTINAM
(AUTONOMOUS)

(Accredited by NAAC with 'A' grade || Recognized by DSIR || Recognized by UGC 2(f) & 12 (B)|| Provisional Accreditation in NBA for EEE, CSE and Mechanical || Approved by AICTE, New Delhi & Affiliated to Anna University, Chennai)

Recommendation for further actions based on feedback and attainment calculation

1. As we got very good feedback in topic coverage and relevance of this seminar, further more we can arrange more relevant and current trend topics seminar
2. Since Objective of the seminar is clearly defined and quality of delivered content is very good, we will arrange more seminars with same resource person
3. Webinar materials are useful but need more clear and in depth concepts we will make more easy materials for understanding and future reference
4. Due to reach of Expected level in program, we will keep arranging similar programs
5. From the students feedback of welcoming , this programme can be conducted for upcoming batch students.

Coordinators

(Dr.D.Devarajan)

(S.K.Pragadesh)

HoD

(Dr. B. Padmanaban)

ATTESTED

Dr. S. RAMABALAN, M.E., Ph.D.,
PRINCIPAL

E.G.S. Pillay Engineering College,
Thethi, Nagore - 611 002.

Nagapattinam (Dt) Tamil Nadu.



**E.G.S. PILLAY ENGINEERING COLLEGE
(AUTONOMOUS)**

NAGAPATTINAM - 611 002

Accredited by NAAC with 'A' grade, Accredited by NBA (EEE, CSE & MECH)
Approved by AICTE - New Delhi. Affiliated to Anna University, Chennai

One day Workshop

On

“Programmable Logic Design”

Organized by

Department of Electrical & Electronics Engineering

Venue: Simulation Lab

16.2.21

ATTESTED

**Dr. S. RAMABALAN, M.E., Ph.D.,
PRINCIPAL**

**E.G.S. Pillay Engineering College,
Thethi, Nagore - 611 002,
Nagapattinam (Dt) Tamil Nadu.**

E.G.S.PILLAY ENGINEERING COLLEGE, NAGAPATTINAM
DEPARTMENT OF ELECTRICAL & ELECTRONICS ENGINEERING

A REPORT ON ONE DAY WORKSHOP

ON

One day workshop on PLC (PLC)

TABLE OF CONTENT

S.NO	PARTICULARS
1.	Report
2.	Approval letter to Principal
3.	Proposed budget
4.	Circular
5.	Attendance
6.	Course material
7.	Photos
8.	Feedback form from participants

ATTESTED

Dr. S. RAMABALAN, M.E., Ph.D.,
PRINCIPAL
E.G.S. Pillay Engineering College,
Thethi, Nagore - 611 002.
Nagapattinam (Dt) Tamil Nadu.



E.G.S. PILLAY ENGINEERING COLLEGE, NAGAPATTINAM

(Autonomous)

Accredited by NAAC with 'A' Grade

Department of Electrical and Electronics Engineering

(Accredited by NBA)

IQAC

A REPORT ON ONE DAY WORKSHOP

ON

ONE DAY WORKSHOP ON Programmable Logic controller(PLC)

Initially, Department of EEE, E.G.S.Pillay Engineering College Nagapattinam is planned to organize a lecture workshop for faculty members of E.G.S. Pillay group of institutions and through discussions it was coined as "Programmable Logic controller". The program was jointly organized by internal quality assurance cell (IQAC). The coordinators identified for this workshop are Prof .S.Latha , and Prof S.Sivamani of EEE department

Internal Experts Dr.V.Mohan. Professor/HOD EEE,Dr.T.Suresh Padmanabhan. Professor/EEE, and Mrs. S.Latha Assistant Professor/EEE was fixed to handle the sessions. The session was inaugurated by the Hon'ble secretary of the Institution Shri.S.Paramesvaran, Principal Dr.S.Ramabalan and controller of Examination Dr.M.Chinnadurai. Prof S.Sivamani welcomed the gathering and followed by inaugural speech by Dr.V.Mohan, HOD/EEE

The session was started by the Internal Expert Mrs.S.Latha with the lecture and demo on "Programmable Logic controller" which is followed with the lecture on Sensors and Actuators by Dr. T.Suresh Padmanabhan on "Programmable Logic controller" and Dr.M.Vijayakumar gave an idea about Electrical engineering in the field of the automation. Mrs.S.Latha AP/EEE started the afternoon session with the lecture on "Ladder Logic functions". The final session was handled by Dr. V.Mohan with the lecture on "Structured logic design". He created an impact and awareness about need for power conservation and its benefits.

Finally, certificates were distributed to all the participants and vote of thanks was proposed by one of the program coordinator Prof. S.Latha of the department of EEE.

S. Latha

COORDINATORS

(Mrs.S.Latha & Mr. S.Sivamani)

S. Sivamani

Dr. V. Mohan

HOD/EEE

(Dr.V.Mohan)

ATTESTED

Dr. S. RAMABALAN, M.E., Ph.D.
PRINCIPAL

E.G.S. Pillay Engineering College,
Thethi, Nagore - 611 002.
Nagapattinam (Dt) Tamil Nadu.

From

Dr.V.Mohan;
Professor & Head - EEE,
Dept. of Electrical and Electronics Engineering,
E.G.S.Pillay Engineering College,
Nagapattinam.

To

The Principal,
E.G.S.Pillay Engineering College,
Nagapattinam.

Respected Sir,

Sub: Requesting permission to conduct one day workshop on **"Programmable Logic controller"** on **16th February 2021** – Reg.,

In association with IQAC, we are planning to organize a one day workshops on **"Programmable Logic controller"**. On **16th February 2021** for all Internal and & External Faculty members have been confirmed to handle the sessions. To organize this lecture, we seek your permission and we need an amount of **Rs. 2500/- (Rupees Two thousand five hundred only)** for organizing this workshop successfully. So, kindly approve for the above said fund towards this workshop.

Thanking You.

Encl Details:

1. Schedule of the Course.
2. Estimated Budget.

Yours sincerely,



(Dr.V.Mohan)

ATTESTED

Dr. S. RAMABALAN, M.E., Ph.D.,
PRINCIPAL
E.G.S. Pillay Engineering College,
Thethi, Nagore - 611 002.
Nagapattinam (Dt) Tamil Nadu.

Nagapattinam,

04-02-2021

From

Dr.V.Mohan,
Professor & Head - EEE,
Dept. of Electrical and Electronics Engineering,
E.G.S.Pillay Engineering College,
Nagapattinam.

To

The Hon'ble Secretary,
E.G.S.Pillay Engineering College,
Nagapattinam.

Respected Sir,

Sub: Requesting permission to conduct one day workshop on "Programmable Logic controller" on 16th February 2021 - Reg.,

In association with IQAC, we are planning to organize a two day workshops on "Programmable Logic controller" on 16th February 2021 for. Internal faculties & External faculty members have been confirmed the sessions. To organize this lecture, we seek your permission and we need an amount of **Rs. 2,500/- (Rupees Two thousand five hundred only)** for organizing this workshop successfully. So, kindly approve for the above said fund towards this workshop.

Thanking You.

Encl Details:

3. Schedule of the Course.
4. Estimated Budget.

Yours sincerely,

(Dr.V.Mohan)

ATTESTED

Dr. S. RAMABALAN, M.E., Ph.D.,
PRINCIPAL

E.G.S. Pillay Engineering College,
Thethi, Nagore - 611 002.
Nagapattinam (Dt) Tamil Nadu.

(i) **Schedule:**

Date	Time	Session details	Resource Person
05.08.2019 & 06.08.2019	9.30am - 10.00am	Inauguration	Staff & Students-
	10.00am - 12.00am	Importance of the PLC	Dr.T.Suresh Padmanabhan. Professor/EEE
	12.00 pm - 01.00 pm	Lunch break	-
	01.00 pm - 04.00 pm	Electrical engineering in the field of the automation	Dr.M.Vijayakumar. Professor/EEE
	10.00pm - 12.00 pm	PLC , Sensors, Actuators, Memory and I/O devices	Dr. V. Mohan, Professor & Head – EEE
	12.00 pm - 01.00 pm	Lunch break	-
	01.00 pm - 02.00 pm	Software used for Programming PLC	Mrs.S.Latha. Assistant Professor/EEE
	02.00 pm - 04.00 pm	Hands on Training	Dr.M.Vijayakumar. Professor/EEE
	04.00 pm - 04.20 pm	Tea break	-
	04.20 pm - 04.50 pm	Feedback & certificate distribution	All Supporting staff

(ii) **Participants details:**

Participants details	Maximum Number of participants
Internal and External Faculty members	36

(iii) **Estimated Budget**

Sl.NO	ITEMS DESCRIPTION	QUANTITY REQUIRED	AMOUNT / QUANTITY IN RS.	ESTIMATED AMOUNT IN RS.
1.	Tea ,Snacks & Lunch	72(1 day session)	25	1800
2.	Invitation & report preparation	-	340	340
3.	Certificate	36	10	360
			Total Amount	2500

Resource Person	Convener	Program Coordinators
Dr.V.Mohan Professor/EEE Dr.T.Suresh Padmanabhan. Professor/EEE Dr.M.Vijayakumar. Professor/EEE	Dr.V.Mohan, Professor & Head - EEE	Mrs.S.Latha, AP/EEE Mr. S.Sivamani, AP/EEE

ATTESTED

Dr. S. RAMABALAN, M.A., Ph.D.,
PRINCIPAL
E.G.S. Pillay Engineering College,
Thethi, Nagore - 611 002.
Nagapattinam (Dt) Tamil Nadu,



E.G.S. PILLAY ENGINEERING COLLEGE

Nagapattinam

(Autonomous)

Accredited by NAAC with 'A' Grade

Department of Electrical and Electronics Engineering

(Accredited by NBA)



CORDIALLY INVITES YOU ALL FOR

ONE DAY WORKSHOP

ON

PROGRAMMABLE LOGIC CONTROLLER (PLC)

Date: 16.02.2021

Venue: Simulation Lab

Smt. Jothimani G.S. Pillay
Chairman – EGSP group of Institutions

Chev. S. Paramesvaran
Secretary - EGSP group of Institutions

Dr.S.Ramabalan
Principal

Dr.V.Mohan
HOD/EEE



E.G.S. PILLAY ENGINEERING COLLEGE

Nagapattinam

(Autonomous)

Accredited by NAAC with 'A' Grade

Department of Electrical and Electronics Engineering

(Accredited by NBA)



CORDIALLY INVITES YOU ALL FOR

ONE DAY WORKSHOP

ON

PROGRAMMABLE LOGIC CONTROLLER (PLC)

Date:16.2.21

Venue: Conference Hall

Smt. Jothimani G.S. Pillay
Chairman – EGSP group of Institutions

Chev. S. Paramesvaran
Secretary - EGSP group of Institutions

Dr.S.Ramabalan
Principal

Dr.V.Mohan
HOD/EEE

Dr.S. RAMABALAN, M.E., Ph.D.,
PRINCIPAL

E.G.S. Pillay Engineering College,
Thethi, Nagore - 611 002.
Nagapattinam (Dt) Tamil Nadu.



E.G.S. PILLAY ENGINEERING COLLEGE, Nagapattinam

(Autonomous)

Accredited by NAAC with 'A' Grade

Department of Electrical and Electronics Engineering

(Accredited by NBA)

CIRCULAR

IQAC

Date: 3-02-2021.

We are happy to announce that a one day workshops on "Programmable Logic controller" on 16th February 2021 is going to be organized by the department of EEE in association with IQAC on 16th February 2021 for all Supporting staff of our Institution. Interested faculty members are requested to register their names to Mrs.S.Latha and Mr.S.Sivamani, AP/EEE on or before 11.02.2021.

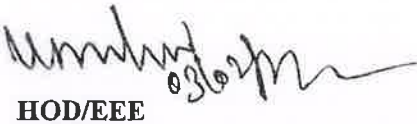
HOD/EEE

Principal

- Copy to: 1. The Honorable Secretary, EGSPEC
2. The Principal, EGSPEC
3. All Department Notice Board



E.G.S. PILLAY ENGINEERING COLLEGE, Nagapattinam

(Autonomous)

Accredited by NAAC with 'A' Grade

Department of Electrical and Electronics Engineering

(Accredited by NBA)

CIRCULAR

IQAC

Date: 3-02-2021.

We are happy to announce that a one day workshops on "Programmable Logic controller" on 16th February 2021 is going to be organized by the department of EEE in association with IQAC on 16th February 2021 for all Supporting staff of our Institution. Interested faculty members are requested to register their names to Mrs.S.Latha and Mr.S.Sivamani, AP/EEE on or before 11.02.2021.

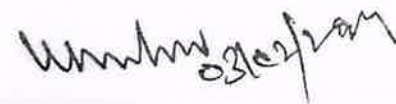
HOD/EEE

Principal

- Copy to: 1. The Honorable Secretary, EGSPEC
2. The Principal, EGSPEC
3. All Department Notice Board

ATTESTED

Dr. S. RAMABALAN, M.E., Ph.D.,
PRINCIPAL
E.G.S. Pillay Engineering College,
Thethi, Nagore - 511 002.
Nagapattinam. (Dt) Tamil Nadu.



E.G.S. PILLAY ENGINEERING COLLEGE, Nagapattinam

(Autonomous)

Accredited by NAAC with 'A' Grade

Department of Electrical and Electronics Engineering

(Accredited by NBA)



ONE DAY WORKSHOP ON

PROGRAMMABLE LOGIC CONTROLLER (PLC)

DATE: 16.2.21

VENUE: SIMULATION LAB

ATTENDANCE

S.NO	STAFF NAME	DEPARTMENT	IN	AN
1.				
2.	Dr. T. J. V. S. P. Adinarayanan	EEE		
3.	Dr. M. Vinath Kumar	EEE		
4.	Mr. A. Aravindhem.	EEE		
5.	Mrs. S. Chitra	ECE		
6.	Dr. M. Vijaya Kumar			
7.	Mrs. S. Lalitha	EEE		
8.	Mr. D. Senthil Kumar	EEE		
9.	Mr. Muthal Srinivasan	ECE		
10.	Mr. Madhu Varadan	ECE		
11.	Mrs. K. Pradheepa	EEE		
12.	Dr. Ishodahamad	ECE		
13.	Mrs. Koteswari	ECE		
14.	Dr. Devasayan. D	ECE		
15.	MRS. L. Ramasethivan	ECE		
16.	MRS. S. Senthil Kumar	ECE		
17.	MRS. S. Adhigai	ECE		
18.	MR. K. Kirthiga	ECE		
19.	MRS. S. Saranya	ECE		
20.	Mrs. Rajamma	ECE		
21.	Mr. K. RAJU	IT		
22.	K. BALASUBRAMANIAN	ECE		
23.	A. Dhanakam	IT		
24.	S. NARUGESH	MECH		
25.	Dr. Sundaravadan	MECH		
26.	K. MANIKANDAN	MECH		
27.	MRS. SANGEETHA	MBA		
28.	SURESH BABU	EEE		
29.	SWAMINI. S	EEE		
30.	Dr. AMARAR. NAIRAN. DINTYAN	EEE		

ATTESTED

Dr. S. RAMABALAN, M.E., Ph.D.,
PRINCIPAL

E.G.S. Pillay Engineering College,
Thethi, Nagore - 611 002.
Nagapattinam (Dt) Tamil Nadu.

HOD/EEE

(Dr. V. Mohan)



E.G.S. PILLAY ENGINEERING COLLEGE, Nagapattinam

(Autonomous)

Accredited by NAAC with 'A' Grade

Department of Electrical and Electronics Engineering

(Accredited by NBA)



ONE DAY WORKSHOP ON

PROGRAMMABLE LOGIC CONTROLLER (PLC)

DATE: 16.2.21

VENUE: SIMULATION LAB

ATTENDANCE

S.NO	STAFF NAME	DEPARTMENT	FN	AN
31.	MRS. R ANAND BABU.	IT	Ranand	Ranand
32.	Dr. Sivaram Krishnan	MECH	Dr. S.K.	Dr. S.K.
33.	Mr. S. SIMHAKUMAR	EEE	S. Simha	S. Simha
34.	J. Jeevamalan	MECH	J. Jeeva	J. Jeeva
35.	F. VEN KATESAN		F. Ven	F. Ven
36.	K. NAGALAKSHMI	IT	Nagalakshi	Nagalakshi

ATTESTED

[Signature]
Dr. S. RAMABALAN, M.E., Ph.D.,
PRINCIPAL

E.G.S. Pillay Engineering College,
Thethi, Nagore - 611 002.
Nagapattinam (Dt) Tamil Nadu.

HOD/EEE
(Dr. V. Mohan)

[Signature]
16/2/2021

Programmable Logic Controller- Block diagram

1. Aim and Objective:

To study of the Programmable Logic Controller.

2. Prerequisites:

Electrical Machines
Power electronics
Control system
Basic C programming

3. Programmable Logic Controller:

3.1. Introduction:

A programmable logic controller (PLC) is a specialized Programmable device which is used to control machines and processes.

It uses a programmable memory to store instructions and execute specific functions that include on/off control, timing, counting, sequencing, arithmetic, and data handling.

Advantages

- Increased *Reliability*
- More *Flexibility*
- Lower *Cost*
- Communications *Capability*
- Faster *Response Time*
- Easier to *Troubleshoot*

3.2 PLC Block diagram

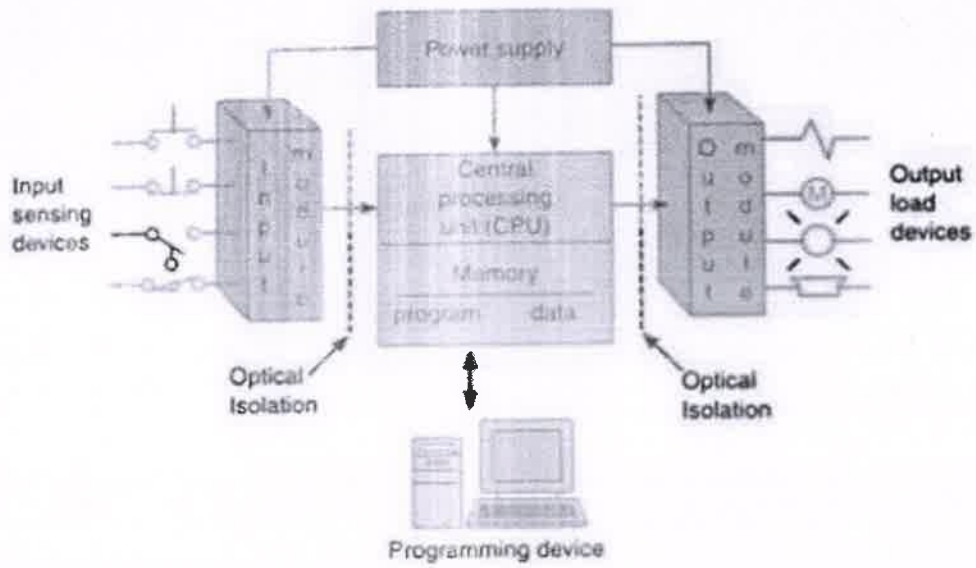

ATTESTED
[Signature]
Dr. S. RAMABALAN, M.E., Ph.D.,
PRINCIPAL
E.G.S. Pillay Engineering College,
Thethi, Nagore - 611 002.
Nagapattinam (Dt) Tamil Nadu.

Central Processing Unit

It is heart of the PLC . CPU is used to store the program, reads the status of inputs through the input module and execute the stored program and appropriate output to be activated based on the logic

CPU has two memory section one section used to store the program and other section is used to store the data

Input Module

- The I/O system forms the interface by which field devices are connected to the controller.
- The purpose of this interface is to condition the various signals received from or sent to external field devices.
- Input devices such as pushbuttons, limit switches, sensors. Selector switches. and thumbwheel switches are hardwired to terminals on the input modules.

Output Module

- Output devices such as small motors, motor starters, solenoid valves. and indicator lights are hardwired to the terminals on the output modules.

Programming device

- The programming device is used to enter the desired program into the memory of processor.
- Ladder logic programming language uses instead of words, graphic symbol...
- It is a special language written to make. it easier for people familiar with relay logic control to program

Power Supply

Leading manufacturer for PLC

- Allen Bradley
- ABB
- Siemens
- Mitsubishi PLC
- Hitachi PLC
- Delta PLC
- General Electric (GE) PLC
- Honeywell PLC

3.3 Input/Output Module

- The I/o system provides an interface between the hardwired components in the field and the CPU.

Input Module

Discrete Input Module

- This type of interface connects field input devices of the ON/OFF nature such as selector switches, pushbuttons and limit switches.
- Likewise, output control is limited to devices such as lights, small motors, solenoids, and motor starters that require simple ON/OFF switching.
- It is interface between the Input field device and CPU of PLC

Input modules perform four tasks in the PLC control system.

- sense when a signal is received from a sensor on the machine
- convert the input signal to the correct voltage level for the particular PLC
- isolate the PLC from fluctuations in the input signal's voltage or current
- send a Signal to the processor indicating which sensor originated the signal

ATTESTED

Dr. S. RAMABALAN, M.E., Ph.D.,
PRINCIPAL
E.G.S. Pillay Engineering College,
Thethi, Nagore - 611 002.
Nagapattinam (Dt) Tamil Nadu.

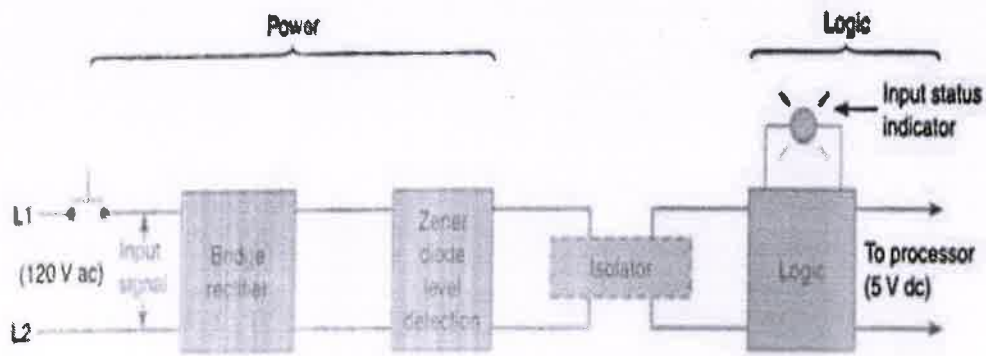

Block diagrams of a discrete input module.

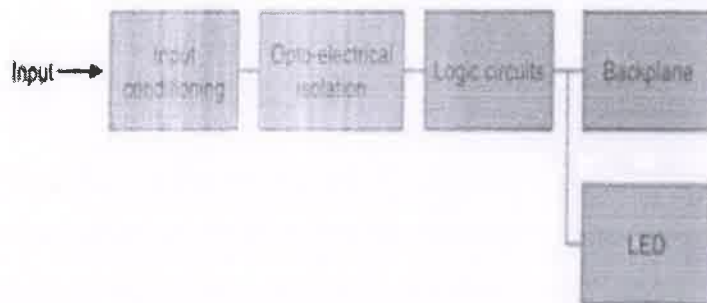

An input filter removes unwanted signal from the electrical interference or key bouncing issue

Opto –electrical isolating section is used to protect the any short circuit fault or high voltage surge from high voltage circuit to logic circuit which normally operated by low voltage

Logic section in the module is used to process the input signal based the pre designed logic and turns ON or OFF the LED

Discrete Output Module

- Discrete output modules typically use the same form of opto-isolation to allow the PLC's computer circuitry to send electrical power to loads:
- it is composed of two basic sections:

the power section and the logic section , coupled by an isolation circuit.

- The output interface can be thought of as a simple electronic switch to which power is applied to control the output device.

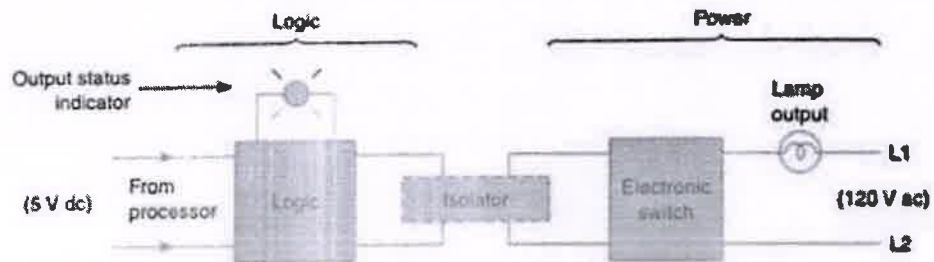

(a) Block diagram of a discrete output module.

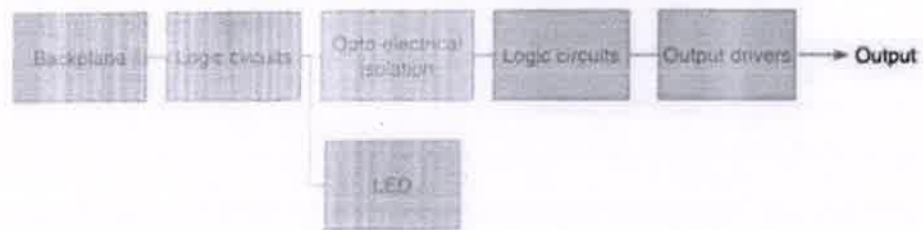

Discrete output modules are used to turn real world output devices either on or off.

- These modules can be used to control any two-state device. and they are available in ac and dc versions and in various voltage ranges and current ratings.
- Output modules can be purchased with *transistor*, triac, or relay output.
- Triac outputs can be used only for control of ac devices. whereas transistor outputs can be used only for control of dc devices. Relay outputs can be used with ac or dc devices.

Analog I/O Module

- Interface with an analog sensor or control device with CPU of PLC through ADC.
- Analog-to-Digital Converter, circuit designed to convert an analog electrical signal into a multi-bit binary word
- Voltage (0 to 10 volt, 0 to 5 volt)
- Current (0 to 20 mA, 4 to 20 mA)

Thermocouple (millivoltage)

Analog input modules

- *Analog input interface modules contain the circuitry necessary to accept analog voltage or current signals from analog field devices.*
- These inputs are converted from an analog to a digital value by an *analog-to-digital (A/D)* converter circuit.
- The conversion value, which is proportional to the analog signal, is expressed as a 12-bit binary or as a 3-digit binary-coded decimal (BCD) for use by the processor.

Analog input interface module connection to a thermocouple

- A varying dc voltage in the millivolt range, proportional to the temperature being monitored, is produced by the thermocouple.
- This voltage is amplified and digitized by the analog input module and then sent to the processor on command from a program instruction.
- Because of the low voltage level of the input signal, a shielded cable is used in wiring the circuit to reduce unwanted electrical noise signals that can be induced in the conductors from other wiring.
- This noise can cause temporary operating errors that can lead to hazardous or unexpected machine operation

AC output Module

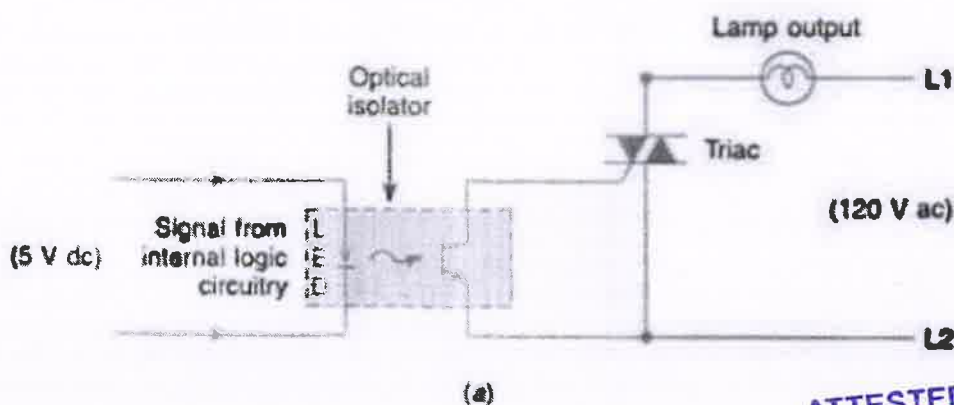

PROGRAMMABLE LOGIC CONTROLLER (PLC)

SNAPSHOT - PLC Program



ATTESTED

Dr. S. RAMABALAN, M.E., Ph.D.,
PRINCIPAL
E.G.S. Pillay Engineering College,
Thethi, Nagore - 611 002.
Nagapattinam (Dt) Tamil Nadu.

SNAPSHOT - PLC Program

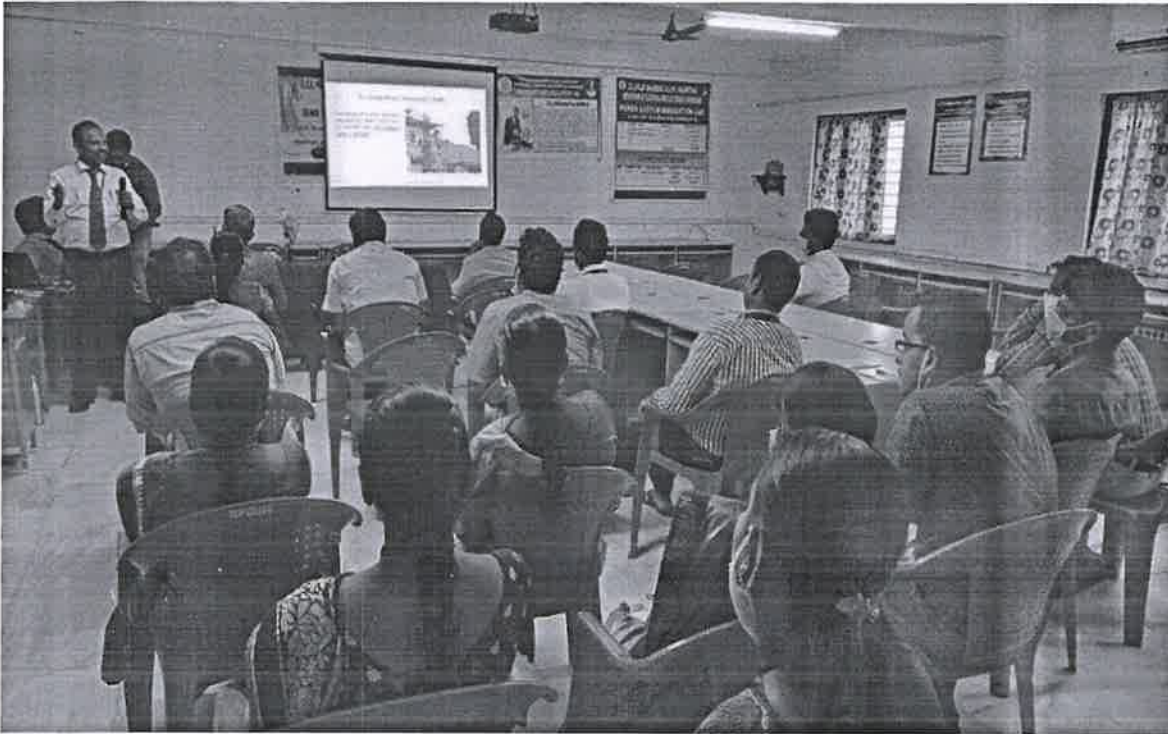

ATTESTED
[Signature]

Dr. S. RAMABALAN, M.E., Ph.D.,
PRINCIPAL

E.G.S. Pillay Engineering College,
Thethi, Nagore - 611 002.

PARTICIPANT FEEDBACK FORM

Program : One day Workshop
Title : **Programmable Logic controller**
Date : 16th February 2021
Coordinators : Mrs.S.Latha & Mr.S. Sivamani
Organizer : Department of Electrical and Electronics Engineering
Institution : E.G.S. Pillay engineering College

Instruction: Please indicate your level of agreement with the statements listed below in scores ranging from 5-1

S.No	Parameters	Strongly Agree (5)	Agree (4)	Neutral (3)	Disagree (2)	Strongly Disagree (1)
1	The objectives of the course were clearly defined	✓				
2	Participation and interaction were encouraged	✓				
3	Topics covered were relevant to the programme	✓				
4	The content was organized and easy to follow	✓				
5	The content is easy to understand useful to analyze	✓				
6	This course experience will be useful in my teaching/ research	✓				
7	Lectures were very informative on current state of art design and useful to apply the concepts	✓				
8	The programme objectives were met	✓				
9	Time allotted for topics were sufficient		✓			
10	The learning environment and facilities were adequate and comfortable	✓				

Overall rating: Excellent (E) / Good (G) / Satisfactory(S) / Poor (P)

Any Suggestions to improve the program :

NIL

Thanks for your valuable feedback

Dr. S. RAMABALAN, M.E., Ph.D.,
PRINCIPAL
E.G.S. Pillay Engineering College,
Thethi, Nagore - 611 002.
Nagapattinam (Dt) Tamil Nadu.

PARTICIPANT FEEDBACK FORM

Program : One day Workshop
 Title : **Programmable Logic controller**
 Date : 16th February 2021
 Coordinators : Mrs.S.Latha & Mr.S. Sivamani
 Organizer : Department of Electrical and Electronics Engineering
 Institution : E.G.S. Pillay engineering College

Instruction: Please indicate your level of agreement with the statements listed below in scores ranging from 5-1

S.No	Parameters	Strongly Agree (5)	Agree (4)	Neutral (3)	Disagree (2)	Strongly Disagree (1)
1	The objectives of the course were clearly defined	✓				
2	Participation and interaction were encouraged		✓			
3	Topics covered were relevant to the programme	✓				
4	The content was organized and easy to follow	✓				
5	The content is easy to understand useful to analyze	✓				
6	This course experience will be useful in my teaching/ research	✓				
7	Lectures were very informative on current state of art design and useful to apply the concepts	✓				
8	The programme objectives were met	✓				
9	Time allotted for topics were sufficient		✓			
10	The learning environment and facilities were adequate and comfortable	✓				

Overall rating: Excellent (E) / Good (G) / Satisfactory(S) / Poor (P)

Any Suggestions to improve the program :

Time allotted is very less.

Thanks for your valuable feedback

ATTESTED

Dr. S. RAMABALAN, M.E., Ph.D.,
PRINCIPAL
 E.G.S. Pillay Engineering College,
 Thethi, Nagore - 611 002.
 Nangunattinam (Dt) Tamil Nadu.



E.G.S. PILLAY ENGINEERING COLLEGE, NAGAPATTINAM

(An Autonomous Institution)

**Affiliated to Anna University, Chennai | Approved by AICTE, New Delhi
Accredited by NAAC with "A" Grade | An ISO 9001:2015 Certified Institution**

25
YEARS OF
EXCELLENCE

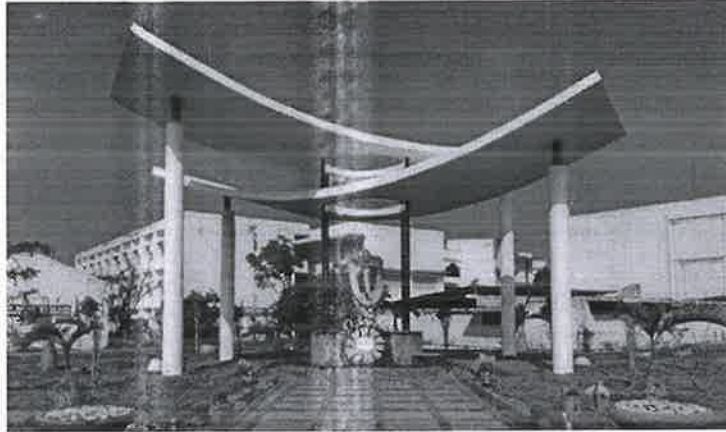

A

REPORT ON THREE DAY WORKSHOP

ON

AV/VR for Biomedical Application

Organized

by

Department of Biomedical Engineering

26, 27 & 28 October 2020

Time: 10.00 AM – 4.00 PM

ATTESTED

**Dr. S. RAMABALAN, M.E., Ph.D.,
PRINCIPAL
E.G.S. Pillay Engineering College
Thethi, Nagore - 611 002.
Nagapattinam (Dt) Tamil Nadu.**

E.G.S.PILLAY ENGINEERING COLLEGE, NAGAPATTINAM

DEPARTMENT OF BIOMEDICAL ENGINEERING

A REPORT ON THREE DAY WORKSHOP

ON

AV/VR for Biomedical Application

TABLE OF CONTENTS

S.NO	PARTICULARS
1.	Report
2.	Approval letter to Principal
3.	Circular
4.	Attendance
5.	Photos
6.	Certificates
7.	Feedback form from participants

ATTESTED

Dr. S. RAMADALAN, M.E., Ph.D.
PRINCIPAL
E.G.S. Pillay Engineering College
Thethi, Nagero - 611 002,
Nagapattinam (Dt) Tamil Nadu.



E.G.S. PILLAY ENGINEERING COLLEGE, NAGAPATTINAM

(Autonomous)

Accredited by NAAC with 'A' Grade
Department of Biomedical Engineering

A REPORT ON THREE DAY WORKSHOP

ON

AV/VR FOR BIOMEDICAL APPLICATION

Department of BME, E.G.S.Pillay Engineering College, Nagapattinam is planned to organize a workshop for teaching faculty members of E.G.S. pillay group of institutions and through discussions it was coined as "**AV/VR for Biomedical Application**". The coordinators identified for this workshop are Prof. R.Ganesan of BME department.

The session was inaugurated by the Hon'ble secretary of the Institution Shri.S.Paramesvaran, and the E. G. S. Pillay trust member Mr. S. Sankarganesh, Principal Dr. S. Ramabalan and Controller of Examination Dr. M. Chinnadurai, Prof R.Ganesan welcomed the gathering by his inaugural speech.

The session was started by the Internal Expert Prof R.Ganesan with the lecture "AV for Biomedical Applications". He created an impact and awareness about applications of the current technology in biomedical and its benefits.

Finally, certificates were distributed to all the participants and vote of thanks was proposed by one of the program coordinator Prof. Prathish Raja.B of the department of BME.

COORDINATOR

(Dr. Prathish Raja.B)

HOD/BME

(Dr. R.Ganesan)

Dr. R. GANESAN, M.E., Ph.D.,
Professor,
Department of Biomedical Engineering,
E.G.S. Pillay Engineering College,
Nagapattinam - 611 002.

ATTESTED

DR. S. RAMABALAN, M.E., Ph.D.,
PRINCIPAL

E.G.S. Pillay Engineering College,
Thethi, Nagore - 611 002.
Nagapattinam (Dt) Tamil Nadu.

From

21-10-20
Nagapattinam,

The HOD,
Dept of Biomedical engineering,
E.G.S.Pillay engineering college,
Nagapattinam.

To

The Principal,
E.G.S.Pillay engineering college,
Nagapattinam.

[Handwritten signature]
21/10/20

Respected sir,

Sub: requesting for conducting hands on workshop- regarding

Sir, we have planned to conduct a hands on workshop on the topic
"AV/VR for biomedical application" along with AMTZ and IBSC on
26/10/2020 to 28/10/2020. So, I kindly request you to give permission
to organize the workshop.

Thank you sir

Yours faithfully

[Handwritten signature]

Dr. R. GANESAN, M.E., Ph.D.,
Professor,
Department of Biomedical Engineering,
E.G.S. Pillay Engineering College,
Nagapattinam - 611 002.



ATTESTED
ATTESTED

[Handwritten signature]
Dr. S. RAMABALAN, M.E., Ph.D.,
PRINCIPAL
E.G.S. Pillay Engineering College,
Thethi, Nagore - 611 002,
Nagapattinam (Dt) Tamil Nadu

E.G.S. PILLAY ENGINEERING COLLEGE

(Autonomous)

Accredited by NAAC with 'A' Grade

Department of Biomedical Engineering

CIRCULAR

Date: 24-10-2020

We are happy to announce that a three day workshop on "AV/VR for Biomedical Application" is going to be organized by the department of BME on 26,27 & 28 October 2020 for all teaching staff of our Institution. All interested faculty members are requested to attend the program.

Venue : Seminar Hall



(Dr. R.Ganesan)

HOD/BME

Dr. R. GANESAN, M.E., Ph.D.,

Professor,

Department of Biomedical Engineering,

E.G.S. Pillay Engineering College,

Nagapattinam - 611 002.

ATTESTED
ATTESTED



Dr. S. RAMABALAN, M.E., Ph.D.,
Dr. S. RAMABALAN, M.E., Ph.D.,
PRINCIPAL
E.G.S. Pillay Engineering College,
Nagapattinam, Nagapattinam - 611 002
Nagapattinam (Dt) Tamil Nadu.

E.G.S PILLAY ENGINEERING COLLEGE

(AUTONOMOUS)

**Approved by AICTE, New Delhi | Affiliated to Anna University,
Chennai. Accredited by NAAC with "A" Grade | Accredited by NBA
(CSE, EEE, MECH)**

NAGAPATTINAM-611002

DEPARTMENT OF BIOMEDICAL ENGINEERING

Hands on Training workshop on

"AV/VR for Biomedical Application "

during 26,27,28th OCT,2020

In association with



Organises

**Online Hands-On Training
Workshop On:
AR/VR for Biomedical
Application**

26, 27, 28th October, 2020

CONVENOR
Dr.R.Ganesan
Prof. and Head / BME



<http://egspec.org/bio.php>

CONVENOR

**Dr.R.Ganesan
HOD / BME**

PRINCIPAL

**Dr.S. Ramabalan
Principal**

ATTESTED

**Dr. S. RAMABALAN, M.E., Ph.D.,
PRINCIPAL**

**E.G.S. Pillay Engineering College,
Thebbi, Nagore - 611 002.
Nagapattinam (Dt) Tamil Nadu.**



EGS PILLAY



ENGINEERING COLLEGE (AUTONOMOUS)

Old nagore road, Nagapattinam - 611 002,

www.egspec.org

Department of Biomedical Engineering

In association with



Organises

Online Hands-On Training

Workshop On

AR/VR for Biomedical

Application

26, 27, 28th October, 2020



CONVENOR

Dr.R.Ganesan

Prof. and Head / BME

ATTESTED

Dr. S. RAMARAJ, M.E., Ph.D.,

EGS Pillay Engineering College,

Nagapattinam - 611 002



<http://egspec.org/bio.php>

E.G.S PILLAY ENGINEERING COLLEGE

Department of Biomedical Engineering

Hands on Training workshop on

“AV/VR for Biomedical Application “

LIST OF FACULTIES ENROLLED

S.NO	Faculty name	Department
1.	Prathish raja.B	BME
2.	Gopikha.N	BME
3.	Ezhilan.N	BME
4.	Saranya.S	BME
5.	Bhuvanewari.N	BME
6.	Geetha Gayathri.V	BME
7.	Anusha.T	BME
8.	Devarajan.D	ECE
9.	Rajaram.A	ECE
10.	Sathya.V	ECE
11.	Senthil Kumar.S	ECE
12.	Nuthal srinivasan.M	ECE
13.	Palanimurugan.S	CSE
14.	Anakath.A.S	CSE
15.	Rajesh.A	CSE
16.	S.Imavathy	CSE
17.	T.Suresh Padmanabhan	EEE
18.	P.J.Suresh Babu	EEE
19.	S.Latha	EEE
20.	S.Manikandan	IT
21.	K.Nagalakshmi	IT
22.	A.Pirakasam	CIVIL
23.	V.C.Keerthi	CIVIL
24.	S.Venkatramanan	CIVIL
25.	B.Ashwini	CIVIL



DR.R.GANESAN
HOD / BME

ATTESTED
ATTESTED

Dr. S. RAMABALAN, M.E., Ph.D.
Dr. S. RAMABALAN, M.E., Ph.D.
PRINCIPAL
E.G.S. Pillay Engineering College,
E.G.S. Pillay Engineering College,
Thethi, Nagapattinam
Nagapattinam - 611 002.

Dr. R. GANESAN, M.E., Ph.D.,
Professor,
Department of Biomedical Engineering,
E.G.S. Pillay Engineering College,
Nagapattinam - 611 002.

E.G.S PILLAY ENGINEERING COLLEGE

Department of Biomedical Engineering







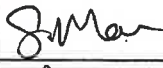
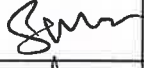
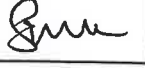

Hands on Training workshop on

“AV/VR for Biomedical Application “

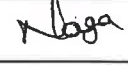
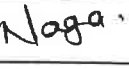
Attendance sheet 26,27,28th OCT,2020

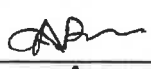
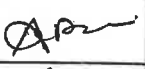
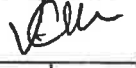
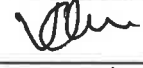
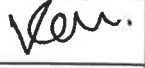
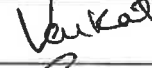
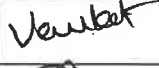
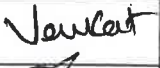
S.NO	Faculty name	Department	Signature 26.10.20	Signature 27.10.20	Signature 28.10.20
1.	Prathish raja.B	BME	B. Pr. Raja	B. Pr. Raja	B. Pr. Raja
2.	Gopikha.N	BME	N. Gu	N. Gu	N. Gu
3.	Ezhilan.N	BME	N. Gu	N. Gu	N. Gu
4.	Saranya.S	BME	S. Gu	S. Gu	S. Gu
5.	Bhuvaneswari.N	BME	N. Gu	N. Gu	N. Gu
6.	Geetha Gayathri.V	BME	V. Gu	V. Gu	V. Gu
7.	Anusha.T	BME	T. Gu	T. Gu	T. Gu
8.	Devarajan.D	ECE	D. Gu	D. Gu	D. Gu
9.	Rajaram.A	ECE	A. Gu	A. Gu	A. Gu
10.	Sathya.V	ECE	V. Gu	V. Gu	V. Gu
11.	Senthil Kumar.S	ECE	S. Gu	S. Gu	S. Gu
12.	Nuthal srinivasan.M	ECE	M. Gu	M. Gu	M. Gu
13.	Palanimurugan.S	CSE	S. Gu	S. Gu	S. Gu
14.	Anakath.A.S	CSE	A.S. Gu	A.S. Gu	A.S. Gu
15.	Rajesh.A	CSE	A. Gu	A. Gu	A. Gu
16.	S.Imavathy	CSE	S. Gu	S. Gu	S. Gu
17.	T.Suresh Padmanabhan	EEE	T. Gu	T. Gu	T. Gu
18.	P.J.SureshBabu	EEE	P.J. Gu	P.J. Gu	P.J. Gu
19.	S.Latha	EEE	S. Gu	S. Gu	S. Gu

ATTESTED

D. S. RAMABALAN, M.E., Ph.D.
PRINCIPAL
 E.G.S. Pillay Engineering College
 Thethi, Nagore - 611 002
 Madurai

20.	S.Manikandan	IT			
21.	K.Nagalakshmi	IT			
22.	A.Pirakasam	CIVIL			
23.	V.C.Keerthi	CIVIL			
24.	S.Venkatramanan	CIVIL			
25.	B.Ashwini	CIVIL			



DR.R.GANESAN
HOD / BME

Dr. R. GANESAN, M.E., Ph.D.,
Professor,
Department of Biomedical Engineering,
E.G.S. Pillay Engineering College,
Nagapattinam - 611 002.

ATTESTED

Dr. S. RAMABALAN, M.E., Ph.D.,
PRINCIPAL

E.G.S. Pillay Engineering College,
Thethi, Nagore - 611 002.
Nagapattinam (Dt) Tamil Nadu.

Department of Biomedical Engineering



E.G.S. PILLAY Engineering College

AUTONOMOUS

Affiliated to Anna University | Approved by AICTE | Accredited by - NBA & NAAC 'A' Grade | Recognised by UGC 2(f) & 12(B) | An ISO 9001:2015 Certified Institution
Counselling Code : 380B | Old Nagore Road, Nagapattinam-BII 002, Tamilnada
+91-4365-251112/14 | principal@egspec.org/enquires@egspec.org

CERTIFICATE OF APPRECIATION

This is to certify that

Dr.B.Prathish raja, Associate Professor, BME,

E.G.S. Pillay Engineering College,Nagapattinam

Has participated three days hands on Training workshop on

“AV/VR for Biomedical Application “

during 26,27,28th OCT,2020 conducted by

Department of Biomedical Engineering, E.G.S. Pillay Engineering College

Dr. R. Ganesan

**Dr.R.Ganesan
Professor &
HOD Biomedical**

Dr. S. Ramabalan

**Dr.S.Ramabalan
Engineering
Principal**

ATTESTED
Dr. S. Ramabalan

Dr. S. Chandrasekar

**Dr.S.Chandrasekar
CEO**

**Dr.S.RAMABALAN, M.E., Ph.D.,
PRINCIPAL**

**Dr.S.Chandrasekar,
Pillay Engineering College,
Thendai Nagar - 614 002,
Nagapattinam (Dt) Tamil Nadu,**

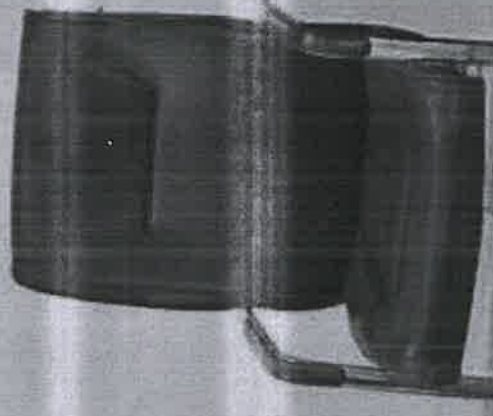
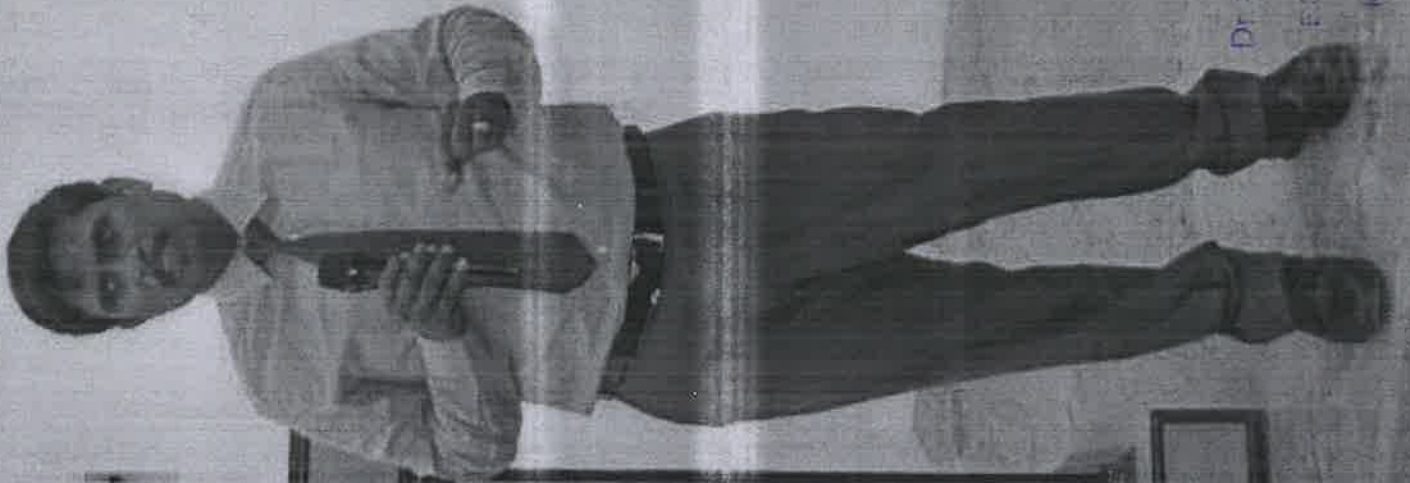

ATTESTED
[Signature]
 DR. S. ... M. ME. PH.D.
 ... College,
 ...

EDS PILLAY
 ENGINEERING COLLEGE
 11, Anna Salai, T. Nagar, Chennai - 600 002

**Department of
 Instrumental Engineering**
 Instrumentation
AMTZ & **IBSC XR**
 Department
 Online Hands-on Training
 Workshops on

**AR/VR for Biomedical
 Application**

25.2K-29K/semester @20%
 Fee, and from F&ME

ESAT **AIMED**
 3D ANIMATION

Physical Application on AR/VR

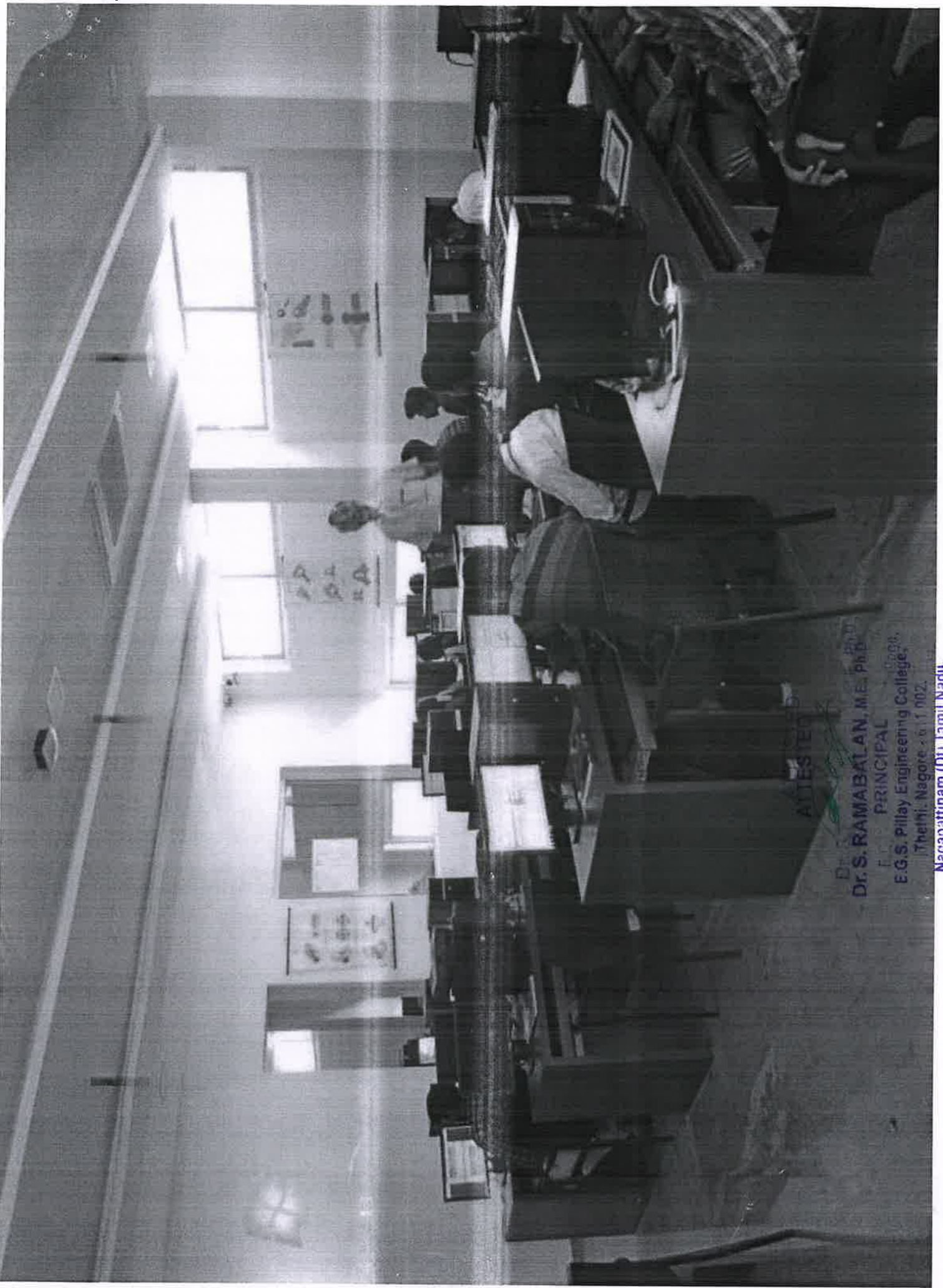

Dr. S. RAMABALAN, M.E., Ph.D.
 PRINCIPAL
 E.G.S. Pillay Engineering College,
 Thethi, Nagore - 611 002.
 Negapattnam (Dt) Tamil Nadu.

ATTESTED

**Hands on Training workshop on
"AV/VR for Biomedical Application "
Participant Feedback Form**

We ask that you take a moment to provide your feedback. Your responses are anonymous and will be used to improve future training methods. Your feedback is important to us.

Participant name: Prathishaj B Dept: BTE Mobile: 8532 457689

Workshop Evaluation

This section helps us understand how future training may need to be adjusted to best respond to participants' needs.

On a scale of 1-4 where 1 is **strongly disagree** and 4 is **strongly agree**, please circle the most appropriate answer:

1. The workshop **venue** was: Strongly disagree – strongly agree

a) Comfortable Strongly disagree – strongly agree
1 2 3 **4**

b) Well located 1 2 **3** 4

Comments: _____

2. The workshop **content** was:

a) Relevant 1 2 **3** 4

b) Comprehensive 1 2 **3** 4

c) Easy to understand 1 2 **3** 4

Comments: _____

3. Workshop **handouts**:

a) Supported presentation material 1 2 3 **4**

b) Provided useful additional information 1 2 **3** 4

c) Were clear and well-organized 1 2 3 **4**

Comments: _____

4. The **workshop**:

a) Was well paced 1 2 **3** 4

b) Breaks were sufficient 1 2 **3** 4

c) Was a good mix between listening and activities 1 2 3 **4**

ATTESTED

Dr. S. RAMAKRISHNAN, M.E., Ph.D.,
PRINCIPAL
E.G.S. Pillay Engineering College,
Thethi, Nagam, W. 107,
Nagapattinam (Dt) Tamil Nadu.

Hands on Training workshop on "AV/VR for Biomedical Application " Participant Feedback Form

We ask that you take a moment to provide your feedback. Your responses are anonymous and will be used to improve future training methods. Your feedback is important to us.

Participant name: Gopikha N Dept: BME Mobile: 9639600456

Workshop Evaluation

This section helps us understand how future training may need to be adjusted to best respond to participants' needs.

On a scale of 1-4 where 1 is **strongly disagree** and 4 is **strongly agree**, please circle the most appropriate answer:

1. The workshop **venue** was:
- Strongly disagree – strongly agree*
- a) Comfortable 1 2 3 4
- b) Well located 1 2 3 4
- Comments: _____

2. The workshop **content** was:
- a) Relevant 1 2 3 4
- b) Comprehensive 1 2 3 4
- c) Easy to understand 1 2 3 4
- Comments: _____

3. Workshop **handouts**:
- a) Supported presentation material 1 2 3 4
- b) Provided useful additional information 1 2 3 4
- c) Were clear and well-organized 1 2 3 4
- Comments: _____

4. The **workshop**:
- a) Was well paced 1 2 3 4
- b) Breaks were sufficient 1 2 3 4
- c) Was a good mix between listening and activities 1 2 3 4

ATTESTED

Dr. S. RAMAKRISHNAN, M.E., Ph.D.,
PRINCIPAL
E.G.S. Pillay Engineering College,
Thethi, Nagore - 625 062.
Nagapattinam (TN) India

E.G.S.PILLAY ENGINEERING COLLEGE(AUTONOMOUS)

NAGAPATTINAM

DEPARTMENT OF COMPUTER SCIENCE AND ENGINEERING

FACULTY DEVELOPMENT PROGRAM

ON

COMPREHENSIVE LEARNING OF PYTHON PROGRAMMING

RESOURCE PERSON

PROF.C.SHAHUL HAMEED M.E,(PhD)

ASSISTANT PROFESSOR

DEPARTMENT OF COMPUTER SCIENCE AND ENGINEERING

SAVEETHA SCHOOL OF ENGINEERING

CHENNAI

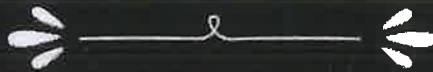

CHIEF GUEST FOR INAUGURATION

MS. A. YASMIN IZATH, M.C.A.,

SOFTWARE ENGINEER

SYSARC INFOMATIX PVT LTD

CHENNAI

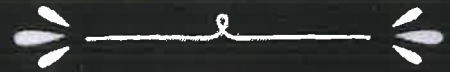

CHIEF GUEST FOR VALEDICTION

MR. A. ASHOK, M.E.,

ALUMNI-EGSPEC

TECHNICAL SUPPORT ENGINEER

RRD INDIA OUTSOURCE PVT LTD

CHENNAI

CONVENER:

PROF.DR. M. CHINNADURAI, M.E, PhD.,

PROF & HEAD/CSE

EVENT COORDINATORS:

PROF. J. NOORUL AMEEN, M.E, (PhD),,

AP/CSE

PROF. DR. T. GANESAN, M.E, PhD.,

PROF/CSE

DATE:

27.06.2021



TIME:

SESSION 1: 10:30 AM

to 12:30 PM

SESSION 2: 01:30 PM

to 03:30 PM

REGISTRATION LINK:

<https://forms.gle/6xJxkYBactCTJrvX9>

PRINCIPAL
E.G.S. Pillay Engineering College,
Thethi, Nagore - 611 002.
Nagapattinam (Dt) Tamil Nadu.

E.G.S. PILLAY ENGINEERING COLLEGE (AUTONOMOUS), NAGAPATTINAM

DEPARTMENT OF CSE

**FACULTY DEVELOPMENT PROGRAM ON COMPREHENSIVE LEARNING OF
PYTHON PROGRAMMING – 27/06/2021**

CONTENTS

1. Requisition Letter
2. Registration Form
3. Response for Registration Form
4. Resource Person Details
5. Invitation to Resource Person and Chief Guest
6. Feedback Form
7. Response for Feedback Form
8. Screenshot and Attendance
9. Certificates
10. Appreciation Letters
11. CO-PO Mapping

ATTESTED

Dr. S. RAMABALAN, M.E., Ph.D.,
PRINCIPAL
E.G.S. Pillay Engineering College.
Thethi, Nagore - 611 002
Nagapattinam (Dt) Tamil

From

J. Noorul Ameen,
Assistant Professor /CSE,
E.G.S Pillay Engineering College,
Nagapattinam.

To

The Principal,
E.G.S.Pillay Engineering College,
Nagapattinam,

Through

Dr. M. Chinnadurai,
The Head of the Department,
Department of Computer Science & Engineering,
E.G.S.Pillay Engineering College,
Nagapattinam,

Respected Sir,

Sub: Need Permission to Conduct Online FDP – Reg.

We have planned to organize FDP on “**COMPREHENSIVE LEARNING OF PYTHON PROGRAMMING**” planned on 27.06.2021. I request you kindly to give the permission to organize this program successfully.

Thanking you

Date: 21/06/2021

Yours faithfully,

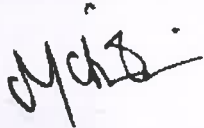
HOD



PRINCIPAL

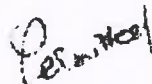

ATTESTED

Dr. S. RAMABALAN, M.E., Ph.D.,
PRINCIPAL
E.G.S. Pillay Engineering College,
Thethi, Nagore - 611
Nagapattinam (Dt) Tam.

FDP ON COMPREHENSIVE LEARNING OF PYTHON PROGRAMMING

Greetings from E.G.S Pillay Engineering College(Autonomous), Department of Computer Science and Engineering , Nagapattinam - 611002, Tamilnadu, India. We are happy to inform you that we have planned to organize FDP on "COMPREHENSIVE LEARNING OF PYTHON PROGRAMMING" on 27/06/2021 and inviting to attend this FDP.

Chief guest for inauguration :

Ms. A. Yasmin Izath, M.C.A.,
Software Engineer
Sysarc Infomatix pvt Ltd
Chennai

Chief guest for valediction:

Mr. A. Ashok, M.E.,
Alumni – EGSPEC
Technical Support Engineer
RRD India Outsource pvt Ltd
Chennai

Resource person:

Prof. C. Shahul Hameed M.E, (PhD)
Assistant Professor
Department of Computer Science and Engineering
Saveetha School of Engineering
Chennai

Coordinators:

1. Prof. J. Noorul Ameen, M.E, (PhD).,
AP/CSE
9150132532
2. Prof. Dr. T. Ganesan, M.E, PhD.,
Prof/CSE
9940742877

Convener:

Prof. Dr. M. Chinnadurai,
Prof & Head/CSE

ATTESTED



Dr. S. RAMABALAN, M.E., Ph.D.,
PRINCIPAL

E.G.S. Pillay Engineering College,
Thethi, Nagore - 611 002,
Nagapattinam (Dt) Tamil Nadu

Email *

anandbabu@egspec.org

Full Name (Upper Case) *

ANAND BABU R

Designation *

Lecturer, Assistant Professor, Associate Professor, Professor...

Assistant professor

Department *

IT

College/Institution Name and Location *

E.G.S.Pillay Engineering college Autonomous

Mobile Number *

Kindly give your whatsapp number

9600768107

Email Id *

anandbabu@egspec.org

ATTESTED

**Dr. S. RAMABALAN, M.E., Ph.D.,
PRINCIPAL**E.G.S. Pillay Engineering College,
Thethi, Nagore - 611 002.

Nagapattinam (Dt), Tamil Na

Native Place *

Nagapattinam

This form was created inside of E.G.S. Pillay Engineering College.

Google Forms

ATTESTED



**Dr. S. RAMABALAN, M.E., Ph.D.,
PRINCIPAL**

E.G.S. Pillay Engineering College,

Thettinagore - 611 302

Nagapattinam (Dt) Tamil Nadu

Timestamp	Email Address	Full Name (Upper Case)	Designation	Department	College/Institution Name & Mobile Number	Email Id	Native Place
6-22-2021 22:13:54	anandbabu@egspec.org	ANAND BABU R	Assistant professor	IT	E.G.S.Pillay Engineering c	9600768107	Nagapattinam
6-22-2021 22:15:04	rvs@egspec.org	R.VETRISELVAN	Programmer	MCA	EGSPEC	9787222143	ARIYALUR
6-22-2021 22:46:10	ranjani@egspec.org	RANJANI B	Assistant Professor	Computer Science and Er	E.G.S.Pillay Engineering (7373902920	Mayiladuthurai
6-22-2021 22:58:24	psgreetha@gmail.com	DR.J.PREETHA	Professor	CSE	Muthayammal Engineering c	94865 95944	Namakkal
6-22-2021 23:07:21	kanimozhi@avccengg.net	Dr R Kanimozhi	Assistant Professor	Information Technology	Avc college of engineering c	9789227971	Mayiladuthurai
6-22-2021 23:23:05	serozekhan.be@gmail.com	FEROZE KHAN S	Fresher	CSE	Vel tech high tech engg c	9884444936	Chennai
6-22-2021 23:27:42	dsathishmf@gmail.com	SATHISH.D	Assistant Professor	Computer Science and Er	Sri Ramanathan Engineer	9894200082	PALLADAM
6-22-2021 23:36:08	shahulhameedc.sse@sav	SHAHUL HAMEED CHET	Assistant Professor	Department of Computer	SAVEETHA INSTITUTE C	9003211337	Chennai
6-22-2021 23:44:29	sarankumar@gmail.com	SARAVANAN	Lecturer	CSC	Velhightech	+917338712963	Chennai
6-23-2021 6:13:32	sreekakani@gmail.com	SRINIVASA RAO KAKANI	Student	Finance	HSBC	09962587527	Chennai
6-23-2021 6:17:43	farvinfarjana@gmail.com	FARJANA FARVIN S	Assistant Professor	CSE	Anjalai Ammal Mahalingar	9965238268	Needamangalam
6-23-2021 7:01:00	parveaz.md@gmail.com	PARVES MOHAMMED	Asst Professor	CSE	Marri Laxman Reddy instit	9848766795	Karimnagar, Telangana
6-23-2021 7:16:54	balaji@egspec.org	BALAJI R	Assistant Professor	MCA	E.G.S.PILLAY ENGINEER	8903940693	Nagapattinam
6-23-2021 8:11:30	devarajan@egspec.org	Dr.D Devarajan	Associate professor	ECE	E.G.S Pillay engineering (9894055342	Nagapattinam
6-23-2021 8:29:14	bala@egspec.org	Dr. K BALASUBRAMANIA	Associate Professor	CSE	E.G.S.PILLAY ENGINEER	9942666526	Nagapattinam
6-23-2021 9:03:52	karthikeyan@citchennai	Dr.Karthikeyan Palaniapp	Associate Professor	CSE	Chennai Institute of Techr	9677781595	Namakkal
6-23-2021 9:17:23	kalaivani@egspec.org	K.Kalaivani	Associate Professor	CSE	E.G.S.Pillay Engineering (9443637775	Nagapattinam
6-23-2021 13:10:24	suguvr@gmail.com	SUGUMARAN V R	Teaching Fellow	Computer Science and Er	University College of Engli	9843110290	Thiruthuraiipoondi
6-23-2021 16:07:08	rbhaskaran@psnacet.edu	Dr.R.Bhaskaran	Professor	IT	PSNACET	9842149872	Madurai
6-23-2021 18:42:23	d.nithyacsse1990@gmail.com	D.NITHYA D	ASSISTANT PROFESSOR	CSE	VELALAR COLLEGE OF I	8220631405	Erode
6-24-2021 6:47:04	hema@egspec.org	Hema A	Assistant professor	MCA	E.G.S.P.E.C	07598690251	Nagapattinam
6-25-2021 14:23:10	maniadt2006@gmail.com	P.MANIKANDA PRABU	Assistant Professor	CSE	Anjalai Ammal Mahalinga	6380152400	SATHANOR
6-25-2021 14:26:59	dinseinfo@gmail.com	DINESH P	Assistant Professor	CSE	ANJALAI AMMAL-MAHAL	7708731903	Thiruvavur
6-25-2021 14:29:31	poongavanam.n22@gmail.com	Mr.N.POONGAVANAM	Assistant Professor	Computer Science and Er	ANJALAI AMMAL MAHAL	7708279666	Thanjavur
6-25-2021 18:27:32	arunkumar.pselvam@gmail.com	ARUNKUMAR P	Assistant Professor	Computer Applications	E.G.S.Pillay Engineering (9003131147	Karaikal
6-25-2021 18:55:44	elakiya@egspec.org	Dr.E.ELAKIYA	Associate Professor	Information Technology	Anjalai Ammal Mahalingar	9952326164	Nagapattinam
6-25-2021 21:47:37	ramrajesh5@gmail.com	RAMA RAJESH	Assistant Professor	IT	Anjalai Ammal Mahalingar	9940829020	Trichy
6-25-2021 21:47:41	venkateshaamec@gmail.com	B VENKATESH	Assistant Professor	Information Technology	Anjalai ammal Mahalingar	9944465098	Kumbakonam
6-25-2021 21:59:07	yogaramesh89@gmail.com	R. YOGAMATHI	Assistant professor	Information Technology	Anjalai ammal mahalingar	9442782069	Thanjavur
6-25-2021 22:12:08	viswamec@gmail.com	VISWANATHAN R V	ASSISTANT PROFESSOR	INFORMATION TECHNOLOGY	ANJALAI AMMAL MAHAL	9790662227	Ammappettai, Thanjavur
6-25-2021 22:20:59	sakthiveera.me@gmail.com	SIVASAKTHI V	Guest Lecturer	Computer science	Thiru. Vi. Ka. Govt Arts C	9597576794	Thanjavur
6-25-2021 22:42:14	jayadd23@gmail.com	D.JAYADURGA	Associate Professor	IT	Anjalai Ammal Mahalingar	+918807503495	Thanjavur
6-25-2021 23:59:32	rpiya.itaamec@gmail.com	R. PRIYA	Assistant Professor	Biochemistry	Anjalai Ammal Mahalingar	94412141013	Thanjavur
6-26-2021 6:05:08	ramamoorthy07@gmail.com	RAMAMURTHY V	Professor	MCA	Marudupandiyar College,	9943728616	Karaikal
6-26-2021 8:36:21	vanitha@egspec.org	VANITHA J	AP	IT	E.G.S.Pillay Engineering (9443728519	Thanjavur
6-26-2021 9:21:26	g.jeyasri@gmail.com	JEYASRI G	Assistant Professor	Information Technology	Anjalai Ammal Mahalingar	94412141013	Thanjavur
6-26-2021 17:02:33	drkavi2020@gmail.com	Dr.KALAIVAZHI VIJAYAR	Associate Professor	Computer Science and Er	E.G.S.Pillay Engineering (9150132532	Nagapattinam
6-26-2021 17:35:04	noornilo@gmail.com	J. NOORUL AMEEN	Assistant Professor	Computer Science and Er	E.G.S.PILLAY ENGINEER	09940742877	Thiruvavur
6-26-2021 19:10:17	ganesan.t@egspec.org	DR.T.GANESAN	Professor	Computer Science and Er	E.G.S.PILLAY ENGINEER	09940742877	Thiruvavur



Dr. S. RAMABALAN, M.E., Ph.D.,
PRINCIPAL

E.G.S. Pillay Engineering College,
Thethi, Nagore - 611 002.
Nagapattinam (Dt) Tamil Nadu.



SHAHUL HAMEED, C.

DCE, B.E., M.E., (PhD)

Cell: +919003211337 | Email: educationsha@gmail.com | Skype: live: shahu_14

Assistant Professor, Department Of Computer Science and Engineering, Saveetha Institute of Medical and Technical Sciences (SIMATS), Saveetha School of Engineering (SSE), Chennai, Tamil Nadu, India.

HANDLED WORKSHOP/CONSULTING/WEBINAR

- ✓ NPR Group of institutions, Training on Python, TEBS, Natham, Tamil Nadu, India
- ✓ S.I.V.E.T College, Training on Python, TEBS, Chennai, Tamil Nadu, India
- ✓ Kalasalingam Institute of Technology, Virudhunagar, Training on Java Vendor Six Phrase
- ✓ Vellore Institute of Technology, Vellore, Training on Java Vendor Smart
- ✓ SRM TRP Engineering College, Tiruchirappalli, Training on Python Vendor Six Phrase
- ✓ SRM Institute Of Science And Technology, Training on Python Vendor Banyan Consultant
- ✓ Adhi College of Engineering Technology, "Tensor Flow Two days workshop"
- ✓ AVC College, Mayiladuthurai, "Development of Mobile Application using Java and Android Studio A One Day Hands-on Training/Workshop for Beginner to Intermediate Level"

INDUSTRIAL EXPERIENCE: 5.9 YEARS and TEACHING EXPERIENCE: 4.3 YEARS TOTAL: 10 YEARS

College	Designation	Duration
Saveetha Institute of Medical and Technical Sciences (SIMATS), Saveetha School of Engineering (SSE), Institute Of Computer Science and Engineering Chennai, Tamil Nadu, India	Assistant Professor	1.3 years Experience 11.03.2020 to till date
Company	Designation	Period
Triflorum Engineering & Business Solutions Chennai, Tamil Nadu, India	Technical Associate	2.5 years Experience 06.10.2017 to 06.03.2020

Project Handled: 2018 to 2019

- ✓ Client : iNoble Infoway for e- Media plan Book using Python, TensorFlow, Amazon SageMaker, AWS(Web Services)
A platform for posting advertisement with immediate impression and to know about the rate/circulation of newspaper automatically.
- ✓ Through a web based application the user could check the advertisement ratings which are published over various newspapers by choosing their desired location.
- ✓ The system helps the user to monitor whether the release of advertisement is positive or negative impressions towards the viewers using Sentimental Analysis by AI.

ATTESTED

Dr. S. RAMABALAN, M.E., Ph.D.,
PRINCIPAL
E.G.S. Pillay Engineering College,
Thethi, Nagore - 611 002.
Nagapattinam (Dt) Tamil Nadu.

Project Handled: 2017 to 2018

Client: Smarta Opti Solutions for e-Mining Book using Android Mobile App Development, J2EE Full Stack Development.

- ✓ To use the E-Mb to monitor the quality of the any civil / public works sanctioned with higher quality product delivery and accuracy on time delivery
- ✓ To use the App as Billing machine combined with Online Banking that could follow-up the works of the person involved and produce necessary bills for further settlement
- ✓ To develop a Mobile application to replicate the E-Mb Web portal

Company	Designation	Period
ICT Academy, Chennai, Tamil Nadu, India	Technical Trainer	2.1 years Experience 12.09.2015–29.09.2017

Hands on Trainings Handled:

Android Mobile App Development, Python, VMware Implementation for the following

Client colleges: Pondicherry.

- ✓ Sri Manakula Vinayakar Engineering College, Pondicherry.
- ✓ Manakula Vinayagar Institute of Technology, Pondicherry.
- ✓ Rajiv Gandhi College of Engineering and Technology, Pondicherry.
- ✓ Achariya College Of Engineering Technology, Pondicherry.
- ✓ Christ College of Engineering and Technology, Pondicherry.
- ✓ Indira Gandhi Art and Science College, Pondicherry.
- ✓ Sri Krishna Engineering College, Pondicherry.
- ✓ Saradha Arts College, Pondicherry.
- ✓ Co-Operative Arts & Science College, Pondicherry.

College	Designation	Period
Panimalar Engineering College, Chennai, Tamil Nadu, India	Assistant Professor	2.5 years Experience 02.01.2013–24.06.2015
	Lab Instructor	7 months Experience 28.05.2012-31.12.2012

Company	Designation	Period
Cognizant Technology Solutions	Process Executive	1 year Experience Nov 2010–Aug 2011

Project : Cognizant Insurance Vertical implementation & support

Client : HARDFORD Platform : ITIL Role : Process Executive

- Receive requests for Insured and services procurements
- Prepare contracts for IRC team
- Coordinate Cancel approvals
- Monitor for delivery status of IRC services within Nodal zone and time constraint guidelines

ATTESTED

Dr. S. RAMABALAN, M.E., Ph.D.,
PRINCIPAL
E.G.S. Pillay Engineering College,
Thethi, Nagore - 611 002.
Nagapattinam (Dt) Tamil Nadu.

EDUCATIONAL QUALIFICATION

Doctor of Philosophy (Computer Science and Engineering) Specialization in Network Security

Title: "Efficient Resources Provisioning Based On Schematic Routing Technique to Maintain Quality of Service in Network Mobility"

Register. No. SP13CSD230

College / University St. Peter's Institute of Higher Education and Research, Avadi,
Chennai – 600 054. Tamil Nadu.

Synopsis Submitted on
27th April 2019

Date of confirmation 12.03.2015

Date of
Registration
31. 07.2013

Status: Synopsis Submitted **Year:** Pursuing **Mode :** Part Time

Marks: 79%
(Course work)

Masters of Engineering (Computer Science and Engineering)

College / University St' Peters University, Chennai, Tamil Nadu, India

First Class **Year:** 2013 **Mode :** Regular **Marks:** 7.26 CGPA

Bachelor of Engineering (Computer Science and Engineering)

College / University Vel Tech High Tech Dr. R.R. & Dr. S.R. Engineering College,
Affiliated to Anna University, Chennai, Tamil Nadu, India

First Class **Year:** 2009 **Mode :** Regular **Marks:** 70%

Diploma in Computer Science and Engineering

College / University Government Polytechnic College, DOTE, Chennai, Tamil Nadu,
India

First Class with HONOURS **Year:** 2006 **Mode :** Regular **Marks:** 75.79%

Secondary School Leaving Certificate

School Name St. Peter's Higher Secondary School, Chennai, Tamil Nadu, India

English Medium - State
Board

Year: 2003

Mode : Regular **Marks:** 82%

ATTESTED

Dr. S. RAMABALAN, M.E., Ph.D.,
PRINCIPAL

E.G.S. Pillay Engineering College,
Thethi, Nagore - 611 002.
Nagapattinam (Dt) Tamil Nadu.

CHIEF GUEST PROFILE

Name : Yasmin Izath A

Schooling : Neelan matric. Hr. Sec. School, Nidamangalam

Qualification : M.C.A.,

UG : STET College for women, Mannargudi

PG : Anjalai Ammal Mahalingam Engineering College, Kovilvenni

Achievements :

1)University Rank Holder in both UG and PG

2)A good team player

Company Name : Sysarc Infomatix pvt. Ltd.,

Experience : 3 years

Our Product is LendPerfect purely Banking

Previous Project : YesBank

Current Project : Abu Dhabi Commercial Bank(ADCB)

ATTESTED

Dr. S. RAMABALAN, M.E., Ph.D.,
PRINCIPAL

E.G.S. Pillay Engineering College,
Thethi, Nadore - 611 002.
N. Gopattinam (Dt) Tamil Nadu.



NOORUL AMEEN J CSE <noorul@egspec.org>

Greetings for E.G.S Pillay Engineering College, Department of CSE

Messages

NOORUL AMEEN J CSE <noorul@egspec.org>
: yasizath11@gmail.com

Mon, Jun 21, 2021 at 9:22 P

From

Prof. J. Noorul Ameen, AP/CSE
Prof. Dr. T. Ganesan, Prof/CSE
EGS Pillay Engineering College
Nagapattinam

Respected Madam

We are happy to inform you that we have planned to organize FDP on "COMPREHENSIVE LEARNING OF PYTHON PROGRAMMING" on 27/06/2021 on behalf of our department. We request you kindly to inaugurate this FDP and awaiting your reply. Herewith we have mentioned event details for your reference.

Thanking you

Yours truly

Prof J. Noorul Ameen AP/CSE

9150132532

Prof Dr. T. Ganesan Prof/CSE

9940742877

(Event Coordinators)

Event Details

Title of the Event	COMPREHENSIVE LEARNING OF PYTHON PROGRAMMING
Event Date	27/06/2021
Event Type	FDP
Participants	Faculties
Resource Person	Prof. C. Shahul Hameed M.E, (PhD) Assistant Professor Department of Computer Science and Engineering

ATTESTED

Dr. S. RAMABALAN, M.E., Ph.D.,
PRINCIPAL

EGS Pillay Engineering College,

Thethi, Nagore - 611 007.

Nagapattinam (Dt) Tamil Nadu.

	Saveetha School of Engineering Chennai
Chief guest for inauguration	Ms. A. Yasmin Izath, M.C.A., Software Engineer Sysarc Infomatix pvt Ltd Chennai
Chief guest for valediction	Mr. A. Ashok, M.E., Alumni – EGSPEC Technical Support Engineer RRD India Outsource pvt Ltd Chennai
Venue	Google meet
Event Coordinator(s)	1. Prof. J. Noorul Ameen, M.E; (PhD)., AP/CSE 2. Prof. Dr. T. Ganesan, M.E, PhD., Prof/CSE
Convener	Prof. Dr. M. Chinnadurai, Prof & Head/CSE

Yasmin Izath <yasizath11@gmail.com>
To: NOORUL AMEEN J CSE <noorul@egspec.org>

Mon, Jun 21, 2021 at 10:42 PM

Dear Sir,

Hope you are doing well. I'm very glad to participate and to share knowledge about technology. Thank you for inviting me.

Best Regards

Yasmin Izath A

Software Engineer

Mobile – 9003360819

[Quoted text hidden]

NOORUL AMEEN J CSE <noorul@egspec.org>
To: Yasmin Izath <yasizath11@gmail.com>

Mon, Jun 21, 2021 at 10:55 PM

Thank you very much madam for your acceptance.
I will share the Google meet link for FDP shortly.

Thanks and best regards

[Quoted text hidden]

ATTESTED

Dr. S. RAMABALAN, M.E., Ph.D.,
PRINCIPAL
E.G.S. Pillay Engineering College
Thethi, Nagapattinam
Nagapattinam, Dt, 18



NOORUL AMEEN J CSE <noorul@egspec.org>

Greetings from E.G.S Pillay Engineering college, Department of CSE

messages

NOORUL AMEEN J CSE <noorul@egspec.org>
 Educationsha@gmail.com

Mon, Jun 21, 2021 at 9:30 P

From

Prof. J. Noorul Ameen, AP/CSE
 Prof. Dr. T. Ganesan, Prof/CSE
 EGS Pillay Engineering College
 Nagapattinam

Respected Sir

We are happy to inform you that we have planned to organize FDP on
 "COMPREHENSIVE LEARNING OF PYTHON PROGRAMMING" on 27/06/2021 on behalf of our
 department. We request you kindly chair the session as resource person for this FDP and
 awaiting your reply. Herewith we have mentioned event details for your reference.

Thanking you

Yours truly

Prof J. Noorul Ameen AP/CSE

9150132532

Prof Dr. T. Ganesan Prof/CSE

9940742877

(Event Coordinators)

Event Details

Title of the Event	COMPREHENSIVE LEARNING OF PYTHON PROGRAMMING
Event Date	27/06/2021
Event Type	FDP
Participants	Faculties
Resource Person	Prof. C. Shahul Hameed M.E. (PhD) Assistant Professor Department of Computer Science and Engineering

ATTESTED

[Signature]
 Dr. S. RAMABALAN, M.E., Ph.D.,
 PRINCIPAL

E.G.S. Pillay Engineering College,
 Nagapattinam (Dt) Tamil Nadu.

	Saveetha School of Engineering Chennai
Chief guest for inauguration	Ms. A. Yasmin Izath, M.C.A., Software Engineer Sysarc Infomatix pvt Ltd Chennai
Chief guest for valediction	Mr. A. Ashok, M.E., Alumni – EGSPEC Technical Support Engineer RRD India Outsource pvt Ltd Chennai
Venue	Google meet
Event Coordinator(s)	1. Prof. J. Noorul Ameen, M.E, (PhD)., AP/CSE 2. Prof. Dr. T. Ganesan, M.E, PhD., Prof/CSE
Convener	Prof. Dr. M. Chinnadurai, Prof & Head/CSE

Educationsha Shahul Hameed Chettali <educationsha@gmail.com>
o: NOORUL AMEEN J CSE <noorul@egspec.org>

Mon, Jun 21, 2021 at 9:39 P

Dear sir,
I accept the invitation. Thank you for the opportunity.

Regards,
Shahul Hameed C
[Quoted text hidden]

NOORUL AMEEN J CSE <noorul@egspec.org>
To: Educationsha Shahul Hameed Chettali <educationsha@gmail.com>

Mon, Jun 21, 2021 at 9:42 P

Thank you very much sir for your acceptance.
I will share the Google meet link for FDP shortly.

Thanks and best regards
[Quoted text hidden]

ATTESTED

Dr. S. RAMABALAN, M.E., Ph.D.,
PRINCIPAL
E.G.S. Pillay Engineering College,
Thethi, Nagore - 611 002,
Nagapattinam (Dt) Tamil Nadu.



NOORUL AMEEN J CSE <noorul@egspec.org>

Greetings from E.G.S Pillay Engineering College, Department of CSE

3 messages

NOORUL AMEEN J CSE <noorul@egspec.org>
To: ashoklingam5@gmail.com

Mon, Jun 21, 2021 at 9:26 P

From

Prof. J. Noorul Ameen, AP/CSE
Prof. Dr. T. Ganesan, Prof/CSE
EGS Pillay Engineering College
Nagapattinam

Respected Sir

We are happy to inform you that we have planned to organize FDP on "COMPREHENSIVE LEARNING OF PYTHON PROGRAMMING" on 27/06/2021 on behalf of our department. We request you kindly to valedict this FDP and awaiting your reply. Herewith we have mentioned event details for your reference.

Thanking you

Yours truly

Prof J. Noorul Ameen AP/CSE

9150132532

Prof Dr. T. Ganesan Prof/CSE

9940742877

(Event Coordinators)

Event Details

Title of the Event	COMPREHENSIVE LEARNING OF PYTHON PROGRAMMING
Event Date	27/06/2021
Event Type	FDP
Participants	Faculties
Resource Person	Prof. C. Shahul Hameed M.E, (PhD) Assistant Professor Department of Computer Science and Engineering

ATTESTED

[Signature]
Dr. S. RAMABALAN, M.E., Ph.D.,
PRINCIPAL

E.G.S. Pillay Engineering College,
Nagapattinam (Dt) Tamil Nadu.

7/2021

E.G.S. Pillay Engineering College Mail - Greetings from E.G.S Pillay Engineering College, Department of CSE

	Saveetha School of Engineering Chennai
Chief guest for inauguration	Ms. A. Yasmin Izath, M.C.A., Software Engineer Sysarc Infomatix pvt Ltd Chennai
Chief guest for valediction	Mr. A. Ashok, M.E., Alumni – EGSPEC Technical Support Engineer RRD India Outsource pvt Ltd Chennai
Venue	Google meet
Event Coordinator(s)	1. Prof. J. Noorul Ameen, M.E, (PhD)., AP/CSE 2. Prof. Dr. T. Ganesan, M.E, PhD., Prof/CSE
Convener	Prof. Dr. M. Chinnadurai, Prof & Head/CSE

Ashok Lingam <ashoklingam5@gmail.com>
To: NOORUL AMEEN J CSE <noorul@egspec.org>

Mon, Jun 21, 2021 at 9:38 P

Hi Noorul,

I received the invitation, I am really excit to attend the session... Thanks for invite.
[Quoted text hidden]

NOORUL AMEEN J CSE <noorul@egspec.org>
To: Ashok Lingam <ashoklingam5@gmail.com>

Mon, Jun 21, 2021 at 9:43 P

Thank you very much sir for your acceptance.
I will share the Google meet link for FDP shortly.

Thanks and best regards
[Quoted text hidden]

ATTESTED

Dr. S. RAMABALAN, M.E., Ph.D.,
PRINCIPAL
E.G.S. Pillay Engineering College,
Thethi, Nagore - 611 002.
Nagapattinam (Dt) Tamil Nadu.

7/2021

E.G.S. Pillay Engineering College Mail - Google meet link for FDP on Comprehensive learning of Python programming

E.G.S Pillay
Engineering College

NOORUL AMEEN J CSE <noorul@egspec.org>

Google meet link for FDP on Comprehensive learning of Python programming

3 messages

NOORUL AMEEN J CSE <noorul@egspec.org>
To: Yasmin Izath <yasizath11@gmail.com>

Sat, Jun 26, 2021 at 6:57 P

Greetings from E.G.S Pillay Engineering College(Autonomous), Department of Computer Science and Engineering , Nagapattinam - 611002, Tamilnadu, India. We are happy to share the Google meet link for FDP on "COMPREHENSIVE LEARNING OF PYTHON PROGRAMMING" on 27/06/2021 and inviting to attend this FDP as chief guest for inauguration at sharply 10:30 am.

We are happy to see your presence on tomorrow.

To join the video meeting, click this link:
<https://meet.google.com/kug-oiio-oro>

To join by phone instead, dial (US) +1 478-298-7611 and enter this PIN: 700 576 518#

Thanks and best regards

Yasmin Izath <yasizath11@gmail.com>
To: NOORUL AMEEN J CSE <noorul@egspec.org>

Sat, Jun 26, 2021 at 8:11 P

Thanks, I will be there.
[Quoted text hidden]

NOORUL AMEEN J CSE <noorul@egspec.org>
To: Yasmin Izath <yasizath11@gmail.com>

Sat, Jun 26, 2021 at 8:16 P

Thank you very much madam
[Quoted text hidden]

ATTESTED

Dr. S. RAMABALAN, M.E., Ph.D.,
PRINCIPAL
E.G.S Pillay Engineering College,
Thethi Nagore - 611002,
Nagapattinam (Dt),

7/2021

E.G.S. Pillay Engineering College Mail - Google meet link for FDP on Comprehensive learning of Python programming

E.G.S Pillay
Engineering College

NOORUL AMEEN J CSE <noorul@egspec.org>

Google meet link for FDP on Comprehensive learning of Python programming

3 messages

NOORUL AMEEN J CSE <noorul@egspec.org>
To: Educationsha Shahul Hameed Chettali <educationsha@gmail.com>

Sat, Jun 26, 2021 at 7:03 P

Greetings from E.G.S Pillay Engineering College(Autonomous),
Department of Computer Science and Engineering ,
Nagapattinam - 611002, Tamilnadu, India. We are happy to
share the Google meet link for FDP on "COMPREHENSIVE
LEARNING OF PYTHON PROGRAMMING" on 27/06/2021
and inviting to chair this FDP as resource person at sharply
10:30 am.

We are happy to see your presence on tomorrow.

To join the video meeting, click this link:
<https://meet.google.com/kug-oio-oro>

To join by phone instead, dial (US) +1 478-298-7611 and enter
this PIN: 700 576 518#

Thanks and best regards

Educationsha Shahul Hameed Chettali <educationsha@gmail.com>
To: NOORUL AMEEN J CSE <noorul@egspec.org>

Sat, Jun 26, 2021 at 7:40 P

Thanks sir, I will be there on time. Thanks & Regards.
Shahul Hameed C

[Quoted text hidden]

NOORUL AMEEN J CSE <noorul@egspec.org>
To: Educationsha Shahul Hameed Chettali <educationsha@gmail.com>

Sat, Jun 26, 2021 at 7:42 P

Thank you very much sir

[Quoted text hidden]

ATTESTED

Dr. S. RAMABALAN, M.E., Ph.D.,
PRINCIPAL
E.G.S. Pillay Engineering College,
Thethi, Nagapattinam - 611 002,
Nagapattinam (Dt), Tamil Nadu.

7/2021

E.G.S. Pillay Engineering College Mail - Google meet link for FDP on Comprehensive learning of Python programming



NOORUL AMEEN J CSE <noorul@egspec.org>

Google meet link for FDP on Comprehensive learning of Python programming

1 message

NOORUL AMEEN J CSE <noorul@egspec.org>
To: Ashok Lingam <ashoklingam5@gmail.com>

Sat, Jun 26, 2021 at 7:00 P

Greetings from E.G.S Pillay Engineering College(Autonomous),
Department of Computer Science and Engineering ,
Nagapattinam - 611002, Tamilnadu, India. We are happy to
share the Google meet link for FDP on "COMPREHENSIVE
LEARNING OF PYTHON PROGRAMMING" on 27/06/2021
and inviting to attend this FDP as chief guest for valediction at
sharply 3:30 pm.

We are happy to see your presence on tomorrow.

To join the video meeting, click this link:
<https://meet.google.com/kug-oio-oro>

To join by phone instead, dial (US) +1 478-298-7611 and enter
this PIN: 700 576 518#

Thanks and best regards

ATTESTED

Dr. S. RAMABALAN, M.E., Ph.D.,
PRINCIPAL
E.G.S. Pillay Engineering College,
Thethi, Nagore - 611002,
Nagapattinam (T.N.), India.

FEEDBACK FORM FOR FDP ON COMPREHENSIVE LEARNING OF PYTHON PROGRAMMING

Greetings from E.G.S Pillay Engineering College(Autonomous), Department of Computer Science and Engineering , Nagapattinam - 611002, Tamilnadu, India. We have successfully completed FDP on "COMPREHENSIVE LEARNING OF PYTHON PROGRAMMING" on 27/06/2021 with your participation.

Kindly give your valuable feedback. After submitting this feedback form you get your participation certificate. Check your inbox/spam folder for certificate

Coordinators:

1. Prof. J. Noorul Ameen, M.E, (PhD).,
AP/CSE
9150132532
2. Prof. Dr. T. Ganesan, M.E, PhD.,
Prof/CSE
9940742877

Email *

noornilo@gmail.com

Full Name (Upper Case) *

J. NOORUL AMEEN

Designation *

Lecturer, Assistant Professor, Associate Professor, Professor...

Assistant Professor

ATTESTED

Dr. S. RAMABALAN, M.E., Ph.D.,
PRINCIPAL
E.G.S Pillay Engineering College,
Thethi, Nagore - 611 002.
Nagapattinam (Dt) Tamil Nadu.

Department, College Name, Location *

Ex: CSE, E.G.S Pillay Engineering College, Nagapattinam

Computer Science & Engineering, E.G.S Pillay Engineering College, Nagapattinam

Mobile Number *

Kindly give your whatsapp number

9150132532

Email Id *

noornilo@gmail.com

Native Place *

Nagapattinam

Objectives of the FDP were clearly met *

- Strongly agree
- Agree
- Neutral
- Disagree
- Strongly Disagree

ATTESTED

Dr. S. RAMABALAN, M.E., Ph.D.,
PRINCIPAL
E.G.S. Pillay Engineering College,
Thethi, Nagore - 611 002
Nagapattinam (Dt.) Tamil Nadu.

FDP was well organized *

- Strongly agree
- Agree
- Neutral
- Disagree
- Strongly Disagree

This FDP increased my knowledge and skills *

- Strongly agree
- Agree
- Neutral
- Disagree
- Strongly Disagree

This FDP as a whole was *

- Excellent
- Good
- Fair
- Poor

ATTESTED

Dr. S. RAMABALAN, M.E., Ph.D.,
PRINCIPAL
E.G.S. Pillay Engineering College,
Thethi, Nagore - 611 002.
Nagapattinam (Dt) Tamil Nadu.

8066

2027 1515332
2027 1539131
2027 1539131
2021 153846
2021 153806
2021 153909
2021 153910
2021 153916
2021 153924
2021 154009
2021 154011
2021 154047
2021 154107
2021 154114
2021 154241
2021 154309
2021 154352
2021 154754
2021 154822
2021 155559
2021 161022
2021 161204
2021 161337
2021 162515
2021 162537
2021 182125

0 J N M N
0 B G U L U
0 D R D
0 SATHISH D
0 A KALAIBELI
0 RANJANI B
0 ARUNKUMAR P
0 VISWANATHAN R V
0 D. JAYADURGA
0 DR J VANITHA
0 SUGUMARAN V R
0 DR KALAIVAZHI VIJAYAR
0 S FARJANA FARVIN
0 DR T GANESAN
0 SHAHUL HAMEED CHET
0 P. MANIKANDA PRABU
0 DR T. GANESAN
0 DR. E. LAKSHMI
0 MR N POONGAVANAM
0 DINESH P
0 P MANIKANDA PRABU
0 R RAMA RAJESH
0 B VENKATESH
0 SVASAKTHIB
0 K MOHAN
0 SVASAKTHIV
0 DR. M. AMBICA
0 JENIFEA G
0 K KALAIVANI

0 J N M N
0 B G U L U
0 D R D
0 SATHISH D
0 A KALAIBELI
0 RANJANI B
0 ARUNKUMAR P
0 VISWANATHAN R V
0 D. JAYADURGA
0 DR J VANITHA
0 SUGUMARAN V R
0 DR KALAIVAZHI VIJAYAR
0 S FARJANA FARVIN
0 DR T GANESAN
0 SHAHUL HAMEED CHET
0 P. MANIKANDA PRABU
0 DR T. GANESAN
0 DR. E. LAKSHMI
0 MR N POONGAVANAM
0 DINESH P
0 P MANIKANDA PRABU
0 R RAMA RAJESH
0 B VENKATESH
0 SVASAKTHIB
0 K MOHAN
0 SVASAKTHIV
0 DR. M. AMBICA
0 JENIFEA G
0 K KALAIVANI

0 J N M N
0 B G U L U
0 D R D
0 SATHISH D
0 A KALAIBELI
0 RANJANI B
0 ARUNKUMAR P
0 VISWANATHAN R V
0 D. JAYADURGA
0 DR J VANITHA
0 SUGUMARAN V R
0 DR KALAIVAZHI VIJAYAR
0 S FARJANA FARVIN
0 DR T GANESAN
0 SHAHUL HAMEED CHET
0 P. MANIKANDA PRABU
0 DR T. GANESAN
0 DR. E. LAKSHMI
0 MR N POONGAVANAM
0 DINESH P
0 P MANIKANDA PRABU
0 R RAMA RAJESH
0 B VENKATESH
0 SVASAKTHIB
0 K MOHAN
0 SVASAKTHIV
0 DR. M. AMBICA
0 JENIFEA G
0 K KALAIVANI

0 J N M N
0 B G U L U
0 D R D
0 SATHISH D
0 A KALAIBELI
0 RANJANI B
0 ARUNKUMAR P
0 VISWANATHAN R V
0 D. JAYADURGA
0 DR J VANITHA
0 SUGUMARAN V R
0 DR KALAIVAZHI VIJAYAR
0 S FARJANA FARVIN
0 DR T GANESAN
0 SHAHUL HAMEED CHET
0 P. MANIKANDA PRABU
0 DR T. GANESAN
0 DR. E. LAKSHMI
0 MR N POONGAVANAM
0 DINESH P
0 P MANIKANDA PRABU
0 R RAMA RAJESH
0 B VENKATESH
0 SVASAKTHIB
0 K MOHAN
0 SVASAKTHIV
0 DR. M. AMBICA
0 JENIFEA G
0 K KALAIVANI

0 J N M N
0 B G U L U
0 D R D
0 SATHISH D
0 A KALAIBELI
0 RANJANI B
0 ARUNKUMAR P
0 VISWANATHAN R V
0 D. JAYADURGA
0 DR J VANITHA
0 SUGUMARAN V R
0 DR KALAIVAZHI VIJAYAR
0 S FARJANA FARVIN
0 DR T GANESAN
0 SHAHUL HAMEED CHET
0 P. MANIKANDA PRABU
0 DR T. GANESAN
0 DR. E. LAKSHMI
0 MR N POONGAVANAM
0 DINESH P
0 P MANIKANDA PRABU
0 R RAMA RAJESH
0 B VENKATESH
0 SVASAKTHIB
0 K MOHAN
0 SVASAKTHIV
0 DR. M. AMBICA
0 JENIFEA G
0 K KALAIVANI

0 J N M N
0 B G U L U
0 D R D
0 SATHISH D
0 A KALAIBELI
0 RANJANI B
0 ARUNKUMAR P
0 VISWANATHAN R V
0 D. JAYADURGA
0 DR J VANITHA
0 SUGUMARAN V R
0 DR KALAIVAZHI VIJAYAR
0 S FARJANA FARVIN
0 DR T GANESAN
0 SHAHUL HAMEED CHET
0 P. MANIKANDA PRABU
0 DR T. GANESAN
0 DR. E. LAKSHMI
0 MR N POONGAVANAM
0 DINESH P
0 P MANIKANDA PRABU
0 R RAMA RAJESH
0 B VENKATESH
0 SVASAKTHIB
0 K MOHAN
0 SVASAKTHIV
0 DR. M. AMBICA
0 JENIFEA G
0 K KALAIVANI

0 J N M N
0 B G U L U
0 D R D
0 SATHISH D
0 A KALAIBELI
0 RANJANI B
0 ARUNKUMAR P
0 VISWANATHAN R V
0 D. JAYADURGA
0 DR J VANITHA
0 SUGUMARAN V R
0 DR KALAIVAZHI VIJAYAR
0 S FARJANA FARVIN
0 DR T GANESAN
0 SHAHUL HAMEED CHET
0 P. MANIKANDA PRABU
0 DR T. GANESAN
0 DR. E. LAKSHMI
0 MR N POONGAVANAM
0 DINESH P
0 P MANIKANDA PRABU
0 R RAMA RAJESH
0 B VENKATESH
0 SVASAKTHIB
0 K MOHAN
0 SVASAKTHIV
0 DR. M. AMBICA
0 JENIFEA G
0 K KALAIVANI

Roll Name (Upper Class)	Designation	Department, College Name, Address	Mobile Number	Email Id	Name Place	Objectives of the FDP were	FDP was well organized	FDP increased my kn	This FDP as a whole was
0 J N M N	Assistant Professor	Computer Science & Engin	9150132532	noornio@gmail.com	Nagapattinam	Strongly agree	Strongly agree	Strongly agree	Excellent
0 B G U L U	Teaching Fellow	CSE, University College of	9643110290	loguv@gmail.com	Thiruburapondudi	Strongly agree	Strongly agree	Strongly agree	Excellent
0 D R D	Assistant Professor	E G S Pillay Engineering C	9894058342	devarajan@gmail.com	Nagapattinam	Agree	Agree	Agree	Excellent
0 SATHISH D	Assistant Professor	CSE, Sri Ramanaiah Efir	9894200082	ishah.shm@gmail.com	Palledam	Strongly agree	Strongly agree	Strongly agree	Excellent
0 A KALAIBELI	Assistant Professor	Computer science and Appl	9159954349	lakhshikva136@gmail.com	Madurai	Strongly agree	Strongly agree	Strongly agree	Excellent
0 RANJANI B	Assistant Professor	CSE, E G S Pillay Enginee	7379502920	lurjunmceae1315@gmail.com	Moyyiduthurai	Strongly agree	Strongly agree	Strongly agree	Excellent
0 ARUNKUMAR P	Assistant Professor	MCA, E G S Pillay Enginee	9003131147	vinikumar.pasuvam@gmail.com	Karaikal	Strongly agree	Strongly agree	Strongly agree	Excellent
0 VISWANATHAN R V	Guest Lecturer	IT, Anjalai Ammal Mahaling	942782089	viswanath@gmail.com	Annapettai, Thanjavur	Agree	Agree	Agree	Excellent
0 D. JAYADURGA	Professor	Computer science, Thiru. A	9587576794	jayadurg@gmail.com	Nagapattinam	Strongly agree	Strongly agree	Strongly agree	Excellent
0 DR J VANITHA	Teaching Fellow	MCA, E G S Pillay Enginee	9443728519	vanitha@egspec.org	Karaikal	Strongly agree	Strongly agree	Strongly agree	Excellent
0 SUGUMARAN V R	Associate Professor	CSE, University College of	9943102930	sujuv@gmail.com	Thiruburapondudi	Strongly agree	Strongly agree	Strongly agree	Excellent
0 DR KALAIVAZHI VIJAYAR	Assistant Professor	Information Technology, A	9442141073	nkrav2020@gmail.com	Thanjavur	Strongly agree	Strongly agree	Strongly agree	Excellent
0 S FARJANA FARVIN	Assistant Professor	CSE, Anjalai Ammal Mahal	9965238288	farvinfarvin@gmail.com	Nidamangalam	Agree	Agree	Agree	Excellent
0 DR T GANESAN	Professor	CSE	09940742877	ganesan_l@egspec.org	Thiruvarur	Strongly agree	Strongly agree	Strongly agree	Excellent
0 SHAHUL HAMEED CHET	Assistant Professor	CSE	9003211337	shahulhameed@gmail.com	Thiruvarur	Strongly agree	Strongly agree	Strongly agree	Excellent
0 P. MANIKANDA PRABU	Assistant Professor	CSE ANJALAI AMMAL M/	6380152400	maniad2005@gmail.com	SATHANCOOR	Strongly agree	Strongly agree	Strongly agree	Excellent
0 DR T. GANESAN	Professor	CSE, E G S PILLAY ENGI	09940742877	ganesan_l@egspec.org	Thiruvarur	Strongly agree	Strongly agree	Strongly agree	Excellent
0 DR. E. LAKSHMI	Associate Professor	CSE, E G S Pillay Enginee	995228164	elakshya@egspec.org	Nagapattinam	Strongly agree	Strongly agree	Strongly agree	Excellent
0 MR N POONGAVANAM	Assistant Professor	CSE, ANJALAI AMMAL MAHAL	770873666	poongavanam.n22@gmail.com	Thanjavur	Strongly agree	Strongly agree	Strongly agree	Excellent
0 DINESH P	ASSISTANT PROFESSOR	Information Technology, A	6380152400	maniad2005@gmail.com	SATHANCOOR	Strongly agree	Strongly agree	Strongly agree	Excellent
0 P MANIKANDA PRABU	Assistant Professor	CSE ANJALAI AMMAL M/	6380152400	maniad2005@gmail.com	SATHANCOOR	Strongly agree	Strongly agree	Strongly agree	Excellent
0 R RAMA RAJESH	Assistant Professor	Information Technology, A	09949419289	ramajesh5@gmail.com	Trichy	Strongly agree	Strongly agree	Strongly agree	Excellent
0 B VENKATESH	Assistant Professor	IT, Anjalai Ammal Mahaling	9940829020	venkateshmanic@gmail.com	Kumbakonam	Strongly agree	Strongly agree	Strongly agree	Excellent
0 SVASAKTHIB	ASSISTANT PROFESSOR	Information Technology, A	9790656227	sakthiveera.rmc@gmail.com	Thanjavur	Agree	Agree	Agree	Good
0 K MOHAN	HOD	CSE, ANJALAI AMMAL MAHAL	09894577935	mohar@uamec.edu.in	Annapet	Strongly agree	Strongly agree	Strongly agree	Excellent
0 SVASAKTHIV	ASSISTANT PROFESSOR	Information Technology, A	9790656227	sakthiveera.rmc@gmail.com	Thanjavur	Agree	Agree	Agree	Good
0 DR. M. AMBICA	Assistant Professor	CSE, ANJALAI AMMAL MAHAL	0994909800	ambikamanni.phd@gmail.com	Thanjavur	Strongly agree	Strongly agree	Strongly agree	Excellent
0 JENIFEA G	Assistant Professor	CSE, K Ramakrishnan C,	948658212	jenifca@gmail.com	Trichy	Strongly agree	Strongly agree	Strongly agree	Excellent
0 K KALAIVANI	Associate Professor	Artificial Intelligence and D	9443837775	kalaivani@egspec.org	Cumbatore	Strongly agree	Strongly agree	Strongly agree	Excellent
		CSE, E G S Pillay Enginee			Nagapattinam				

ATTESTED



Dr. S. RAMABALAN, M.E., Ph.D.,
PRINCIPAL
E.G.S. Pillay Engineering College,
Thethi, Nagore - 611 002.
Nagapattinam (Dt) Tamil Nadu.

People X

Mute all Add people Host controls

G	J	Shahul Hameed C...	Elamaran Packiris...	KALAI SIVA	A	Anandbabu R	sathish d	Sree Kalyanji	venkatesh bhara...
GANESAN T CSE	Jaya durga	Shahul Hameed C...	Elamaran Packiris...	KALAI SIVA	A	Anandbabu R	sathish d	Sree Kalyanji	venkatesh bhara...
Anunkumar Panne...	Yasmin Izath	P Manikanda Prabu	Yogamathi Ramesh	Educationisha Sha...	7 others	You		viswa Nathan	Yasmin Izath
Poongavanam N	Nilofer Begam	Dr. J Vanitha	Educationsha Sha...					viswa Nathan	Yasmin Izath
venkatesh bhara...	Jamal Mohamed	Viswa Nathan							

26

🔍 🗨️ 📄 📞

🔊 📺 📷 📱 📞

🔊 📺 📷 📱 📞

People

Mute all Add people Host controls

	GANESAN T CSE		Jaya durga		Shahul Hameed Chettali
	Elamaran Pacliriswamy		KALAI SIVA		Arunkumar Panneerselvam
	Yasmin Izath		19 others		Sree KAKANI
					venkatesh charith
					Vinodhini Vino
					Vigns Nathan

27

Info Chat Share

Phone

Thethi, Nagore - 611-002.
Nagapattinam (Dt) Tamil Nadu.

[Handwritten signature]

Accredited by NBA(B.E-CSE,ECE,EEE,Mech,Civil/B.Tech-IT)

Approved by AICTE, New Delhi

enquiries@egspec.org



Accredited by NAAC with Grade 'A'

An ISO 9001:2015 Certified Institution | Recognised by UGC 2(f) & 12(B)

+91-4365-251112 | +91-4365-251114

Old Nagore Road, Thethi, Nagapattinam - 611002, Tamil Nadu . NIRF Engineering Ranking top 200 in India

DEPARTMENT OF COMPUTER SCIENCE AND ENGINEERING

CERTIFICATE OF PARTICIPATION

This is to certify that **B VENKATESH**, Assistant Professor, IT, Anjalai Ammal Mahalingam Engineering College, Kovilvenni has actively participated in the "FDP ON COMPREHENSIVE LEARNING OF PYTHON PROGRAMMING" organized by department of Computer Science and Engineering, E.G.S Pillay Engineering College, Nagapattinam through online pedagogy on **27/06/2021**

J. Noorul Ameen Coordinator	Dr. T. Ganesan Coordinator	Dr. M. Chinnadurai Convenor & HoD	Dr. S. Ramabalan Principal
--------------------------------	-------------------------------	--------------------------------------	-------------------------------

Certificate ID: KIMMVE-CE0000001682

This is system generated E certificate. Signature is not mandatory

Made for free with Certify'em

DR. S. RAMABALAN, M.E., Ph.D.,
PRINCIPAL

E.G.S. Pillay Engineering College,
Thethi, Nagore - 611 002,
Nagapattinam (Dt) Tamil Nadu.

E.G.S. PILLAY ENGINEERING COLLEGE (AUTONOMOUS)

Accredited by NBA(B.E-CSE,ECE,EEE,Mech,Civil)/B.Tech-IT)

Affiliated to Anna University, Chennai | Approved by AICTE, New Delhi

principal@egspec.org | enquires@egspec.org



Accredited by NAAC with Grade 'A'

An ISO 9001:2015 Certified Institution | Recognised by UGC 2(f) & 12(B)

+91-4365-251112 | +91-4365-251114

Counselling Code: 3806

Old Nagore Road, Thethi, Nagapattinam - 611002, Tamil Nadu NIRF Engineering Ranking top 200 in India

DEPARTMENT OF COMPUTER SCIENCE AND ENGINEERING

CERTIFICATE OF HONOUR

This is to certify that **Ms. A. Yasmin Izath, M.C.A.**, Software Engineer, Sysarc Infomatix pvt Ltd, Chennai has inaugurated the session as **chief guest** in the "FDP ON COMPREHENSIVE LEARNING OF PYTHON PROGRAMMING" organized by department of Computer Science and Engineering, E.G.S Pillay Engineering College, Nagapattinam through online pedagogy on **27/06/2021**

J. Noorul Ameen	Dr. T. Ganesan	Dr. M. Chinnadurai	Dr. S. Ramabalan
Coordinator	Coordinator	Convenor & HoD	Principal

Certificate ID: {{certificate id}}

This is system generated certificate. Signature is not mandatory

Dr. S. RAMABALAN
PRINCIPAL

E.G.S. Pillay Engineering College,
Thethi, Nagore - 611 002,
Nagapattinam (Dt) Tamil Nadu.

E.G.S. PILLAY ENGINEERING COLLEGE (AUTONOMOUS)

Accredited by NBA|B.E-CSE,ECE,EEE,Mech,Civil|B.Tech-IT|

Affiliated to Anna University, Chennai | Approved by AICTE, New Delhi

principal@egspec.org | enquires@egspec.org

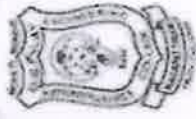

Accredited by NAAC with Grade 'A'

An ISO 9001:2015 Certified Institution | Recognised by UGC-2(F) & 12(B)

+91-4365-251112 | +91-4365-251114

Counselling Code : 3806

Old Nagore Road, Thethi, Nagapattinam - 611002, Tamil Nadu NIRF Engineering Ranking top 200 in India

DEPARTMENT OF COMPUTER SCIENCE AND ENGINEERING

CERTIFICATE OF HONOUR

This is to certify that **Prof. C. Shahul Hameed M.E. (PhD)**, Assistant Professor, Department of Computer Science and Engineering, Saveetha School of Engineering, Chennai has chaired the session as **resource person** in the "FDP ON COMPREHENSIVE LEARNING OF PYTHON PROGRAMMING" organized by department of Computer Science and Engineering, E.G.S Pillay Engineering College, Nagapattinam through online pedagogy on **27/06/2021**

J. Noorul Ameen
Coordinator

Dr. T. Ganesan
Coordinator

Dr. M. Chinnadurai
Convenor & HoD

Dr. S. Ramabalan
Principal

Certificate ID: ~~EGSPEC~~ {Certificate id}}

This is system generated E certificate. Signature is not mandatory

Dr. S. RAMABALAN, M.E., Ph.D.,

PRINCIPAL

E.G.S. Pillay Engineering College,

Thethi, Nagore - 611 002.

E.G.S. PILLAY ENGINEERING COLLEGE (AUTONOMOUS)

Accredited by NBA/B.E-CSE,ECE,EEE,Mech,Civil/B.Tech-IT)

Affiliated to Anna University, Chennai | Approved by AICTE, New Delhi

principal@egspec.org | enquires@egspec.org



Accredited by NAAC with Grade 'A'

An ISO 9001:2015 Certified Institution | Recognised by UGC 2(f) & 12(B)

+91-4365-251112 | +91-4365-251114

Counselling Code : 3806

Old Nagore Road, Thethi, Nagapattinam - 611002, Tamil Nadu NIRF Engineering Ranking top 200 in India

DEPARTMENT OF COMPUTER SCIENCE AND ENGINEERING

CERTIFICATE OF HONOUR

This is to certify that **Mr. A. Ashok, M.E.**, Alumni – EGSPEC, Technical Support Engineer, RRD India Outsource pvt Ltd, Chennai has **valedicted** the session as **chief guest** in the “FDP ON COMPREHENSIVE LEARNING OF PYTHON PROGRAMMING” organized by department of Computer Science and Engineering, E.G.S Pillay Engineering College, Nagapattinam through online pedagogy on **27/06/2021**

J. Noorul Ameen	Dr. T. Ganesan	Dr. M. Chinnadurai	Dr. S. Ramabalan
Coordinator	Coordinator	Convenor & HoD	Principal

Certificate ID: *(Handwritten ID)* {certificate id}}

This is system generated E certificate. Signature is not mandatory

Dr. S. RAMABALAN, M.E., Ph.D.
PRINCIPAL

E.G.S. PILLAY ENGINEERING COLLEGE (AUTONOMOUS)

Accredited by NBA|B.E-CSE,ECE,EEE,Mech,Civil|B.Tech-IT)

Affiliated to Anna University, Chennai | Approved by AICTE, New Delhi

principal@egspec.org | enquires@egspec.org



Accredited by NAAC with Grade 'A'

An ISO 9001:2015 Certified Institution | Recognised by UGC 2(f) & 12(B)

+91-4365-251112 | +91-4365-251114

Counselling Code : 3806

Old Nagore Road, Thethi, Nagapattinam - 611002, Tamil Nadu NIRF Engineering Ranking top 200 in india

DEPARTMENT OF COMPUTER SCIENCE AND ENGINEERING

CERTIFICATE OF HONOUR

This is to certify and appreciate that **Mr. D. Dinesh**, III year CSE student, has served as **brochure designer** in the "FDP ON COMPREHENSIVE LEARNING OF PYTHON PROGRAMMING" organized by department of Computer Science and Engineering, E.G.S Pillay Engineering College, Nagapattinam through online pedagogy on **27/06/2021**

J. Noorul Ameen

Dr. T. Ganesan

Dr. M. Chinnadurai

Dr. S. Ramabalan

Coordinator

Coordinator

Convenor & HoD

Principal

ATTESTED

Certificate ID: {{certificate id}}

DR. R. S. SIVASUBRAMANIAM

M.E., Ph.D.,
PRINCIPAL

E.G.S. Pillay Engineering College, Thethi, Nagore - 611002, Nagapattinam (Dt) Tamil Nadu.

Thethi, Nagore - 611002.

Nagapattinam (Dt) Tamil Nadu.

6/27/2021

E.G.S. Pillay Engineering College Mail - Greetings from E.G.S Pillay Engineering College(Autonomous), Nagapattinam



NOORUL AMEEN J CSE <noorul@egspec.org>

Greetings from E.G.S Pillay Engineering College(Autonomous), Nagapattinam

2 messages

NOORUL AMEEN J CSE <noorul@egspec.org>
To: Yasmin Izath <yasizath11@gmail.com>

Sun, Jun 27, 2021 at 4:50 PM

Respected Madam

On behalf of CSE department, E.G.S Pillay Engineering College, Nagapattinam, we thank you very much for inaugurating today's FDP on Comprehensive learning of python programming - 27/06/2021 as chief guest by giving your valuable inaugural address.

Hereby I have attached your certificate for chief guest
PFA

We thank you very much for your support.

Thanks and best regards

Prof J. Noorul Ameen
Prof T. Ganesan
(Coordinators - FDP)

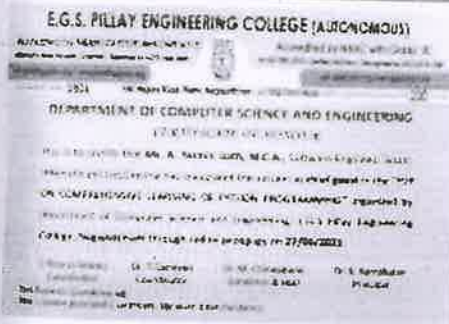

Inauguration chief guest certificate template for python FDP 2021.jpg
147K

Yasmin Izath <yasizath11@gmail.com>
To: NOORUL AMEEN J CSE <noorul@egspec.org>

Sun, Jun 27, 2021 at 6:01 PM

Thanks a lot.
[Quoted text hidden]

ATTESTED

Dr. S. RAMABALAN, M.E., Ph.D.,
PRINCIPAL
E.G.S. Pillay Engineering College,
Thethi, Nagore - 611 002,
Nagapattinam (Dt) Tamil Nadu.



NOORUL AMEEN J CSE <noorul@egspec.org>

Greetings from E.G.S Pillay Engineering College(Autonomous), Nagapattinam

2 messages

NOORUL AMEEN J CSE <noorul@egspec.org>

To: Educationsha Shahul Hameed Chettali <educationsha@gmail.com>

Sun, Jun 27, 2021 at 4:29 PM

Respected sir

We thank you very much for today's FDP on Comprehensive learning of python programming - 27/06/2021 on behalf of CSE department, E.G.S Pillay Engineering College, Nagapattinam.

You did a wonderful presentation with crisp and clarity.

We also received wonderful feedback from all the participants

We have sent honorarium of 4000 rs for your effort.

Hereby we have attached a copy of GPAY receipt and resource person certificate to you. PFA.

We will approach you for upcoming programs also. Kindly support
Thanks for your support

Thanks and best regards

Prof J. Noorul Ameen
Prof T. Ganesan
(Coordinators - FDP)

2 attachments



Resource person certificate template for python FDP 2021.jpg
154K



IMG-20210627-WA0001.jpg
46K

ATTESTED
[Signature]
Dr. S. RAMABALAN, M.E., Ph.D.,
PRINCIPAL
E.G.S. Pillay Engineering College,
Thethi, Nagore - 611 002.
Nagapattinam (Dt), Tamil Nadu.

27/2021

E.G.S. Pillay Engineering College Mail - Greetings from E.G.S Pillay Engineering College(Autonomous), Nagapattinam

To: NOORUL AMEEN J CSE <noorul@egspec.org>

Respected Sir,

It's indeed a great privilege for me to receive this certificate of honour from E.G.S Pillay Engineering College(Autonomous).

I am very much thankful to you for honouring me for excelling in the responsibility that is being given to me. I will keep my enthusiasm up in my future work as well. Awards like this are the boosters for personnel like me.

Thank you once again for this great honour and appreciation.

Thanking you,

Regards,

Shahul Hameed C

+919003211337

Chennai.

[Quoted text hidden]

ATTESTED

Dr. S. RAMABALAN, M.E., Ph.D.,
PRINCIPAL

E.G.S. Pillay Engineering College,
Thethi, Nagore - 611 002.
Nagapattinam (Dt) Tamil Nadu.

Chinnadurai Sir Cug
Forwarded



Respected Professors,
We have successfully conducted the FDP on comprehensive learning of Python programming today. The session was conducted in two sessions and e-certificates were distributed. On behalf of CSE Department, I express my sincere thanks to our Management, CEO, principal and COE, Hod and faculties of our and other institutions for giving us immense support and encouragement. I convey my special thanks to Prof C. Sahul Hameed, Savitha school of engineering for charing as resource person for these two sessions and Ms. Yasmin Izath Software Engineer, Sysarc Infomatix Pvt Ltd for inaugurating the FDP. I congratulate Prof J. Noorul Ameen and Prof Dr. T. Ganesan for organizing and coordinating the event successfully. Thank you.

ATTESTED
[Signature]
Dr. S. RAMABALAN, M.E., Ph.D.,
PRINCIPAL
E.G.S. Pillay Engineering College,
Thethi, Nagore-611 002.
Nagapattinam (Dr. Tamil Na



NOORUL AMEEN J CSE <noorul@egspec.org>

Greetings from E.G.S Pillay Engineering College(Autonomous), Nagapattina

2 messages

NOORUL AMEEN J CSE <noorul@egspec.org>

Sun, Jun 27, 2021

To: Educationsha Shahul Hameed Chettali <educationsha@gmail.com>

Respected sir

We thank you very much charing today's FDP on Comprehensive learning of python programming - 27/06/2021 of CSE department, E.G.S Pillay Engineering College, Nagapattinam.

You did a wonderful presentation with crisp and clarity.

We also received wonderful feedback from all the participants

We have sent honorarium of 4000 rs for your effort.

Hereby we have attached a copy of GPAY receipt and resource person certificate to you. PFA.

We will approach you for upcoming programs also. Kindly support Thanks for your support

Thanks and best regards

Prof J. Noorul Ameen
Prof T. Ganesan
(Coordinators - FDP)

2 attachments

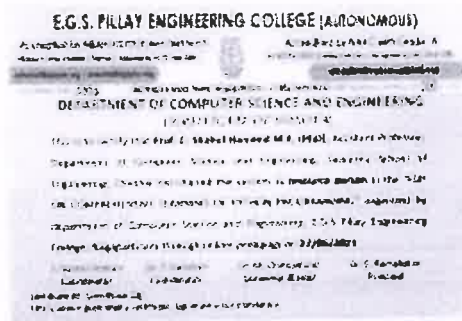

Resource person certificate template for python FDP 2021.jpg
154K



IMG-20210627-WA0001.jpg
46K

ATTESTED
[Signature]
Dr. S. RAMABALAN, M.E., Ph.D.,
PRINCIPAL
E.G.S. Pillay Engineering College,
Thethi, Nagore - 611 002.
Nagapattinam (Dt) Tamil Nadu.

Educationsha Shahul Hameed Chettali <educationsha@gmail.com>

Sun, Jun 27, 2021

6/27/2021

E.G.S. Pillay Engineering College Mail - Greetings from E.G.S Pillay Engineering College(Autonomous), Nagapattinam

To: NOORUL AMEEN J CSE <noorul@egspec.org>

Respected Sir,

It's indeed a great privilege for me to receive this certificate of honour from E.G.S Pillay Engineering College(Autonomous).

I am very much thankful to you for honouring me for excelling in the responsibility that is being given to me. I will keep my enthusiasm up in my future work as well. Awards like this are the boosters for personnel like me.

Thank you once again for this great honour and appreciation.

Thanking you,

Regards,

Shahul Hameed C

+919003211337

Chennai.

[Quoted text hidden]

ATTESTED

Dr. S. RAMABALAN, M.E., Ph.D.,
PRINCIPAL

E.G.S. Pillay Engineering College,
Thethi, Nagore - 611 002.

Citizen (D) Tamil Nadu

E.G.S PILLAY ENGINEERING COLLEGE, NAGAPATTINAM
DEPARTMENT OF COMPUTER SCIENCE AND ENGINEERING
FDP on "Comprehensive Learning of Python programming" Date: 27/06/2021

COURSE OUTCOMES

At the end of this FDP faculty can able to

CO Number	Competency	Cognitive level
CO1	Read, write and execute simple python programs.	Understand
CO2	Decompose a python program into functions	Apply
CO3	Represent data using python lists, tuples and files	Apply

COs Vs POs/PSOs Matrix

(Support provided by COs to POs: L = lightly(1); M = Moderately (2); S = Substantially (3))

CO/PO	PO1	PO2	PO3	PO4	PO5	PO6	PO7	PO8	PO9	PO10	PO11	PO12	PSO 1	PSO 2
CO1	2	1	1	-	-	-	-	-	-	-	-	-	2	-
CO2	3	3	3	-	-	-	-	-	-	-	-	-	3	-
CO3	3	3	2	-	-	-	-	-	-	-	-	-	3	-

ATTESTED

Dr. S. RAMABALAN, M.E., Ph.D.,
PRINCIPAL

E.G.S. Pillay Engineering College,
Thethi, Nagore - 611 002,
Nagapattinam (Dt) Tamil Nadu.



(Approved by AICTE, Affiliated to Anna University (Autonomous))
(Accredited by NAAC with "A" Grade)
(Accredited by NBA)

Hands on Training Programme in C Programming for Non Teaching Staffs



Organized by

*Department of CSE
E.G.S Pillay Engineering
College
Nagapattinam -- 611 002
Tamil Nadu.*

Resource Person

*Mr. J. Noorul Ameen M.E.,
&
Mr. A. Baskar M.E.,
Assistant Professors/ CSE,
E.G.S Pillay Engineering College,
Nagapattinam -- 611 002*

ATTESTED

Dr. S. RAMABALAN, M.E., Ph.D.,
PRINCIPAL
E.G.S. Pillay Engineering College,
Thethi, Nagore - 611 002.
Nagapattinam (Dt) Tamil Nadu.

E.G.S. Pillay Engineering College (Autonomous), Nagapattinam-611002.

Department of Computer Science and Engineering

**Three Days hands on Training Programme in C Programming for Non
Teaching Staffs (15/07/2020 to 17/07/2020)**

CONTENTS

1. Circular
2. Requisition Letter
3. Synopsis of the Seminar
4. Resource Person Details
5. Participants Attendance
6. PO-CO Mapping
7. Sample Feedback
8. Sample Photos
9. Certificates

ATTESTED

**Dr. S. RAMABALAN, M.E., Ph.D.,
PRINCIPAL**

**E.G.S. Pillay Engineering College,
Thethi, Nagore - 611 002.
Nagapattinam (Dt) Tamil Nadu**

From

K. Balasubramanian
Associate Professor
Department of Computer Science and Engineering
E.G.S. Pillay Engineering College
Nagapattinam

To

The Secretary
E.G.S. Pillay Group of Institutions
Nagapattinam

Through

The Director- Academies
E.G.S. Pillay Group of Institutions
Nagapattinam

Sir

Sub: Requesting permission to conduct the workshop Reg.

We are happy to inform you that Programmers Paradise Club, Department of CSE is planned to organize free days hands on workshop on C for non-teaching staff of E.G.S. Pillay Engineering College from 15.07.2020 to 17.07.2020. Herewith we enclosed the proposal for your reference. Kindly give permission to conduct the workshop.

Thanking you

Penned
Masi
Dr. M. CHINNAIDURAI, M.E., Ph.D.,
Professor & HOD.
Dept. of Computer Science & Engg.
E.G.S. Pillay Engineering College,
Nagapattinam.



Y. Subramanyam
Y. Subramanyam
Event Coordinator

ATTESTED

Prof.
Dr. S. RAMABALAN, M.E., Ph.D.,
PRINCIPAL
E.G.S. Pillay Engineering College,
Thethi, Nagore - 611 002
Nagapattinam (Dt) Tamil Nadu.

E.G.S. PILLAY ENGINEERING COLLEGE (AUTONOMOUS), NAGAPATTINAM
DEPARTMENT OF COMPUTER SCIENCE AND ENGINEERING

CIRCULAR

EGSPEC/CSE/JUL2020/01

08/07/2020

Greetings from department of CSE. We are going to organize "Hands on Training Programme in C Programming for Non Teaching Staffs" from 15/07/2020 to 17/07/2020. In this regard all non teaching staff members of our college are requested to attend this workshop.

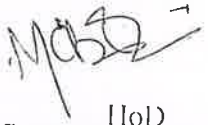
(HOD)
HEAD OF THE DEPARTMENT
DEPARTMENT OF CSE
E.G.S.P. Engineering College,
Nagapattinam - 611 002

CC to: The Secretary, All Hods, PED, COE, Account Office, Office File

ATTESTED

Dr. S. RAMABALAN, M.E., Ph.D.,
PRINCIPAL
E.G.S. Pillay Engineering College,
Thethi. Nagore - 611 002.
Nagapattinam (Dt) Tamil Nadu.

E.G.S. PILLAY ENGINEERING COLLEGE (AUTONOMOUS), NAGAPATTINAM

DEPARTMENT OF CSE

Hands on Training Programme in C Programming for Non Teaching Staffs

Synopsis of the training program Date: 15/07/2020 to 15/07/2020

Department of Computer Science and Engineering conducted “**Hands on Training C Programming for Non Teaching Staffs**”.

- Coordinators: Prof J.Noorul Ameen(AP/CSE) and Prof A. Baskar (AP/CSE)
- Convenor: Prof Dr. M. Chinnadurai/ Prof & HoD / CSE

Inaugurated and supported by our beloved joint secretary Chev Mr Paramesvaran sir, Dr S. Ramabalan Principal, Dr. V. Mohan academic director, Dr. M. Chinnadurai HoD CSE department and professors of CSE department .

Drived by Prof J.Noorul Ameen, Assistant Professor, Department of CSE.

Non teaching staffs from our engineering college are actively participated.

Outcome of the training programme:

1. Understand the code reusability with the help of user defined functions.
2. Analyze the structure concept, union, file management and preprocessor in C language.

We thank our management, principal sir, academic director sir and dept Hod sir for giving permission to conduct this training program successfully.

We thank Thamarai Kannan sir of CSE Department for making necessary lab arrangements.

ATTESTED

Dr. S. RAMABALAN, M.E., Ph.D.,
PRINCIPAL
E.G.S. Pillay Engineering College,
Thethi, Nagore - 611 002.
Nagapattinam (Dt) Tamil Nadu.

J. NOORUL AMEEN

9, Yahusain Palli Street, Nagapattinam, TamilNadu, India 611001 |(C) +919150132532 | noornilo@gmail.com

PROFESSIONAL SUMMARY

To contribute to the growth of an educational institution by working as faculty, where I will have opportunities to build and refine my teaching skills and knowledge seeking a role offering opportunities for long term professional growth and development.

SKILLS

- C/C++/Java
- Desktop and Laptop repair
- AWS Academy Cloud Foundation
- Internal components installation
- AWS Academy Cloud Architecting
- Antivirus solutions
- EMCAA
- MS Office

WORK HISTORY

JUNE 2013 (Full Time)

Assistant Professor | E.G.S Pillay Engineering College | Nagapattinam, Tamilnadu, India

- Teaching various subjects for undergraduate computer engineering subjects especially in the area of cloud computing
- Coordinating the activities of students
- Working as department placement coordinator
- Organizing committee coordinator of various international conferences
- Internal reviewer of various international conferences
- Motivating students on co-curricular activities...

AUGUST 2012 - MAY 2013

Assistant Professor | AL Ameen Engineering College | Erode, Tamilnadu, India

- Delivered lectures on various subjects for undergraduate computer engineering subjects
- Monitoring the activities of students
- Managed hostel as deputy warden

JANUARY 2009 - MAY 2010

Software and Hardware Trainer | Orbit Computer Education | Thiruvarur, Tamilnadu, India

- Trained students on windows, C, C++, Java technologies
- Trained students on computer hardware - Assembling, Troubleshooting, Installation and Maintenance
- Monitored proper working of computers

ATTESTED

Dr. S. RAMABALAN, M.E., Ph.D.,
PRINCIPAL
E.G.S. Pillay Engineering College,
Thethi, Nagore - 611 002,
Nagapattinam (Dt) Tamil Nadu.

EDUCATION

2017 – Present

PhD: Information and Communication Engineering

Area of Research: Load Balancing in Cloud Computing

University: Anna University Chennai.

2012

ME: Computer Science & Engineering

Velalar College of Engineering and Technology, Erode, Tamilnadu, India

2008

BE: Computer Science & Engineering

E.G.S Pillay Engineering College, Nagapattinam, Tamilnadu, India

CERTIFICATIONS

- AWS Academy Cloud Foundations
- AWS Academy Cloud Architecting
- EMC Academic Associate, Cloud Infrastructure and Services(EMCAA)
- Ranksheet Certified Professional(RCP)
- CIU Certified Hardware Associate(CCHA)

AREA OF INTEREST

- Cloud Computing
- Computer Networks

MEMBERSHIP

- Life member of Indian society for technical education(MISTE)

CONFERENCE PUBLICATIONS

International

- A Secure and Integrated P2P Platform for Distributed, Collaborative and Ubiquitous Computing using JXTA
- Designing Graphical Password Scheme Using PCCP
- Dynamic Auditing Protocol for Efficient and Secured Data Storage in Cloud Computing
- Improving Source Privacy and Network Life Time in Energy Efficient Manner
- Phishing Attack Identification using Visual Cryptography
- Fake Wi-Fi Access Point Detector for Android Smart phones
- Innovative Schemes for Resource Allocation in the Cloud for Media Streaming Application

JOURNAL PUBLICATIONS

- **Evolutionary Algorithm Based Adaptive Load Balancing (EA-ALB) in Cloud Computing Framework** – IASC, Intelligent Automation And Soft Computing, ISSN: 1079-8587 Volume 32 Issue 2 – MAY 2022

Dr. S. RAMABALAN, M.E., Ph.D.
PRINCIPAL
E.G.S. Pillay Engineering College,
Thethi, Nagore - 611 002,
Nagapattinam (TN)

- **Competitive Resource Allocation in Hetnets: Pricing, Bandwidth Allocation and Spectrum Sharing** – IRJET, International Research Journal of Engineering and Technology, ISSN: 2395 – 0056 Volume 8 Issue 6 – JUNE 2021
- **Image CAPTCHA Based Authentication for Phishing Websites Identification** - IJETCSE, International journal of emerging technology in computer science and electronics, ISSN: 0976-1353 Volume 13 Issue 4 –MARCH 2015
- **Dynamic Auditing Protocol for Efficient and Secure Data Storage in Cloud Computing** - COMPUSOFT, An international journal of advanced computer technology, 3 (6), June-2014 (Volume-III, Issue-VI)
- **Efficient Authentication Scheme Using PCCP** - COMPUSOFT, An international journal of advanced computer technology, 3 (6), June-2014 (Volume-III, Issue-VI)

DECLARATION

I hereby declare that the information furnished above is true to the best of my knowledge.

Date :

Place:

(J. Noorul Ameen)

ATTESTED



Dr. S. RAMABALAN, M.E., Ph.D.,
PRINCIPAL

E.G.S. Pillay Engineering College,
Thethi, Nagore - 611 002.
Nagapattinam (Dt) Tamil Nadu.

ANEXURE - II
(To be submitted to the inspection Committee)
ANNA UNIVERSITY
CHENNAI – 600 025



RESUME

Name of the College : E.G.S.Pillay Engineering College,
Nagapattinam
Name of the Department : Computer Science & Engg.
Name of the Faculty Member : A. Baskar
Present Designation : Assistant Professor
Residential Address : 1/1-142 Ambalakara street,
Koppampatti(PO), Thuraiyur (tk), Trichy(dist)
Contact Nos. : Landline: Mobile: 9791916587
Email: baskarait@gmail.com
Gender : Male
PAN Number : Passport Number :
Date of Birth : 09.01.1987

1. Particulars of Educational Qualification :

Category	Name of the Degree	Specialization	Year of Passing	Name of the College	Name of the University	% of Marks / Grades obtained	Class obtained
UG	B.E.,	Information Technology	2009	Kurinji College of Engineering & Technology	Anna university	71%	1st
PG	M.E.,	Computer Science & Engg.	2014	BIT Campus, Tiruchirappalli	Anna University	7.07(CGPA)	1st

*Enclose copies of certificates and testimonials duly attested by the faculty member and the principal as proof.

- I. a. Additional Qualification : NIL
i. GATE Score (In case of B.E. / B.Tech.)
ii NET / SLET (In case of M.C.A. / M.Sc. / M.A.)
II. Title of Ph.d. Thesis *
III. Faculty in which Ph.d. was awarded : NIL

IV. Academic Experience as on 31st December 2014:

Name of the College	Designation	Joining Date	Relieving Date	Experience		
				Years	Months	Days
E.G.S.Pillay College Of Engineering	Assistant Professor	12.01.2011	-	5	7	12

ATTESTED

Dr. S. RAMABALAN, M.E., Ph.D.,
PRINCIPAL
E.G.S. Pillay Engineering College,
Thethi, Nagore - 611 002.
Nagapattinam (Dt) Tamil Nadu.

E.G.S. PILLAY ENGINEERING COLLEGE(AUTONOMOUS), NAGAPATTINAM

DEPARTMENT OF CSE

Hands on Training Programme in C Programming for Non Teaching Staffs – 15/07/2020 to 17/07/2020

Attendance Sheet

S. NO	NAME	DESIGNATION	DEPARTMENT	SIGNATURE	
				15/07/2020	16/07/2020
1.	KALIYAMURTHY.G	OFFICE SUPERINTENDENT	ACCOUNTS	<i>[Signature]</i>	<i>[Signature]</i>
2.	ELANCHELIAN	LAB ASSISTANT	CSE	<i>[Signature]</i>	<i>[Signature]</i>
3.	A VIGNESHKUMAR	LAB ASSISTANT	ECE	<i>[Signature]</i>	<i>[Signature]</i>
4.	MATHURABASHINI. R	ASSISTANT LIBRARIAN	LIBRARY	<i>[Signature]</i>	<i>[Signature]</i>
5.	SUMATHI. R	ASSITANT LIBRARIAN	LIBRARY	<i>[Signature]</i>	<i>[Signature]</i>
6.	MURUGANANDAM G	LIBRARIAN	LIBRARY	<i>[Signature]</i>	<i>[Signature]</i>
7.	SRIKRISHNABABU,R	LAB TECHNICIAN	MCA	<i>[Signature]</i>	<i>[Signature]</i>
8.	SAKTHIVEL. S	SKILLED ASSISTANT	MECH	<i>[Signature]</i>	<i>[Signature]</i>
9.	S.VENKATESAN	SKILLED ASSISTANT	MECH	<i>[Signature]</i>	<i>[Signature]</i>
10.	SENTHIL MJRUGAN. S	SKILLED ASSISTANCE	MECH	<i>[Signature]</i>	<i>[Signature]</i>
11.	D.VELAVAN	PHYSICAL DIRECTOR	PHYSICAL EDUCATION	<i>[Signature]</i>	<i>[Signature]</i>
12.	VIJAYASANKAR.S	TECHNICAL ASSISTANT	SAH	<i>[Signature]</i>	<i>[Signature]</i>
13.	RAJU. K	SERVICE ENGINEER	ECE	<i>[Signature]</i>	<i>[Signature]</i>
ATTENDED				<i>[Signature]</i>	<i>[Signature]</i>
ATTENDED				<i>[Signature]</i>	<i>[Signature]</i>

Dr. S. RAMABALAN, M.E., Ph.D.,
PRINCIPAL

E.G.S. Pillay Engineering College,
Thethi, Nagore - 611 002.
Nagapattinam (Dt) Tamil Nadu.

E.G.S PILLAY ENGINEERING COLLEGE, NAGAPATTINAM

DEPARTMENT OF CSE

(Approved by AICTE, Affiliated to Anna University)

(Accredited by NBA)

(Accredited by NAAC with "A" Grade)

Three days hands on Training programme in C Programming for Non Teaching Staffs

COURSE OUTCOMES

At the end of this training programme, attendees can able to

CO Number	Competency	Cognitive level
CO1	Demonstrate fine grained operations in number system.	Understand
CO2	Gain exposure in programming language using C	Apply
CO3	Develop programming skills using the fundamentals and basics of C Language.	Apply

S. No	Name	Department	Designation	CO1	CO2	CO3
1.	KALIYAMURTHY.G	OFFICE SUPERINTENDENT	ACCOUNTS	3	3	3
2.	ELANCHELIAN	LAB ASSISTANT	CSE	3	3	3
3.	A VIGNESHKUMAR	LAB ASSISTANT	ECE	2	2	2
4.	MATHURABASHINI. R	ASSISTANT LIBRARIAN	LIBRARY	3	3	3
5.	SUMATHI. R	ASSITANT LIBRARIAN	LIBRARY	3	3	3
6.	MURUGANANDAM G	LIBRARIAN	LIBRARY	2	2	2
7.	SRIKRISHNABABU,R	LAB TECHNICIAN	MCA	3	3	3
8.	SAKTHIVEL. S	SKILLED ASSISTANT	MECH	3	3	3
9.	S.VENKATESAN	SKILLED ASSISTANT	MECH	3	3	3
10.	SENTHIL MURUGAN. S	SKILLED ASSISTANCE	MECH	3	3	3
11.	D.VELAVAN	PHYSICAL DIRECTOR	PHYSICAL EDUCATION	3	3	3
12.	VIJAYASANKAR.S	TECHNICAL ASSISTANT	SAH	3	3	3
13.	RAJU. K	SERVICE ENGINEER	ECE	2	2	2
14.	MUTHUNAYAKAM. P	LAB ASSISTANT	IT	3	3	3
15.	SHANMUGAM. B	LIBRARIAN	LIBRARY	2	2	2
TOTAL				38	41	39
ATTAINMENT				84	91	87
ATTAINMENT LEVEL				3	3	3

Attainment Level 1,2,3

Attainment Level 1: >70%

Attainment Level 2: >80%

Attainment Level 3: >90%

ATTESTED

Dr. S. RAMABALAN, M.E., Ph.D.,
PRINCIPAL
E.G.S. Pillay Engineering College,
Thethi, Nagore - 611
Nagapattinam, D.T. & C.

E.G.S. PILLAY ENGINEERING COLLEGE(AUTONOMOUS), NAGAPATTINAM
DEPARTMENT OF CSE

Hands on Training Programme in C Programming for Non Teaching Staffs – 15/07/2020 to 17/07/2020

Feedback Form

Name: R. SUMATHI
Designation: Assistent Librarian.
Department: Library

At the end of this training program, attendees can able to

S.NO	COURSE OUTCOME	COGNITIVE LEVEL	RATINGS			
			Highly Agree	Agree	Neutral	Disagree
CO1	Demonstrate fine grained operations in number system.	Understand	—			
CO2	Gain exposure in programming language using C	Apply		—		
CO3	Develop programming skills using the fundamentals and basics of C Language.	Apply		—		

ATTESTED



Dr. S. RAMABALAN, M.E., Ph.D.,
PRINCIPAL

E.G.S. Pillay Engineering College,
Thethi, Nagore - 611 002.
Nagapattinam (Dt) Tamil Nadu.

R. Sumathi
Signature of the Attendee

**E.G.S. PILLAY ENGINEERING COLLEGE(AUTONOMOUS), NAGAPATTINAM
DEPARTMENT OF CSE**

Hands on Training Programme in C Programming for Non Teaching Staffs – 15/07/2020 to 17/07/2020

Feedback Form

Name: **K. RAJU**

Designation: **SERVICE ENGINEER**

Department: **ECE**

At the end of this training program, attendees can able to

S.NO	COURSE OUTCOME	COGNITIVE LEVEL	RATINGS			
			Highly Agree	Agree	Neutral	Disagree
CO1	Demonstrate fine grained operations in number system.	Understand	✓			
CO2	Gain exposure in programming language using C	Apply	✓	✓		
CO3	Develop programming skills using the fundamentals and basics of C Language.	Apply		✓		

ATTESTED



Dr. S. RAMABALAN, M.E., Ph.D.,

PRINCIPAL

**E.G.S. Pillay Engineering College,
Thethi, Nagore - 611 002.
Nagapattinam (Dt) Tamil Nadu.**

Signature of the Attendee

E.G.S. PILLAY ENGINEERING COLLEGE(AUTONOMOUS), NAGAPATTINAM
DEPARTMENT OF CSE

Hands on Training Programme in C Programming for Non Teaching Staffs – 15/07/2020 to 17/07/2020

Feedback Form

Name: **KALIYA MURTHY . S**

Designation: **OFFICE SUPERINTENDENT**

Department: **ACCOUNTS**

At the end of this training program, attendees can able to

S.NO	COURSE OUTCOME	COGNITIVE LEVEL	RATINGS			
			Highly Agree	Agree	Neutral	Disagree
CO1	Demonstrate fine grained operations in number system.	Understand	/			
CO2	Gain exposure in programming language using C	Apply	/			
CO3	Develop programming skills using the fundamentals and basics of C Language.	Apply	/			

ATTESTED



Dr. S. RAMABALAN, M.E., Ph.D.,
PRINCIPAL

E.G.S. Pillay Engineering College,
Thethi, Nagore - 611 002.
Nagapattinam (Dt) Tamil Nadu.

Signature of the Attendee



ATTESTED

Dr. S. RAMABALAN, M.E., Ph.D.,
PRINCIPAL

E.G.S. Pillay Engineering College,
Thethi, Nagore - 611 002
Nagapattinam (Dt) Tamil Nadu.

E.G.S. PILLAY ENGINEERING COLLEGE (AUTONOMOUS)

Accredited by NBA(B.E-CSE,ECE,EEE,Mech,Civil/B.Tech-IT)

Affiliated to Anna University, Chennai | Approved by AICTE, New Delhi



Accredited by NAAC with Grade 'A'

An ISO 9001:2015 Certified Institution | Recognised by UGC 2(f) & 12(B)

principal@egspec.org | enquires@egspec.org

+91-4365-251112 | +91-4365-251114

Counselling Code: **3806**

Old Nagore Road, Thelhi, Nagapattinam - 611002, Tamil Nadu NIRF Engineering Ranking Top **200** in India

DEPARTMENT OF COMPUTER SCIENCE AND ENGINEERING

CERTIFICATE OF COMPLETION

This is to certify that **VIGNESH KUMAR A, LAB ASSISTANT / ECE** has successfully completed **Hands on Training Programme in C Programming for Non Teaching Staffs** Conducted by Department of Computer Science and Engineering, E.G.S Pillay Engineering College, Nagapattinam from 15/07/2020 to 17/07/2020

J. Noorul Ameen
Coordinator

A. Baskar
Coordinator
ATTESTED
Dr. S. RAMABALAN, M.E., Ph.D.,
Principal

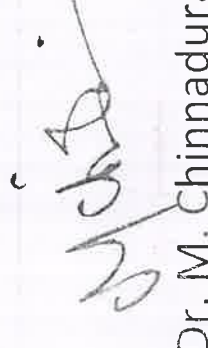
Dr. M. Chinnadurai
HoD

Dr. S. Ramabalan
Principal

E.G.S. Pillay Engineering College,
Thelhi, Nagore - 611 002,
Nagapattinam (Dt) Tamil Nadu.

E.G.S. PILLAY ENGINEERING COLLEGE (AUTONOMOUS)

Accredited by NBA(B.E-CSE,ECE,EEE,Mech,Civil/B.Tech-II)

Affiliated to Anna University, Chennai | Approved by AICTE, New Delhi



Accredited by NAAC with Grade 'A'

An ISO 9001:2015 Certified Institution | Recognised by UGC 2(f) & 12(B)

principal@egspec.org | enquires@egspec.org

+91-4365-251112 | +91-4365-251114

Counselling Code : **3806**

Old Nagore Road, Thelhi, Nagapattinam - 611002, Tamil Nadu NIR Engineering Ranking Top 200 in India

DEPARTMENT OF COMPUTER SCIENCE AND ENGINEERING

CERTIFICATE OF COMPLETION

This is to certify that **SAKTHIVELS, SKILLED ASSISTANT / MECH** has successfully completed **Hands on Training Programme in C Programming for Non Teaching Staffs** Conducted by Department of Computer Science and Engineering, E.G.S Pillay Engineering College, Nagapattinam from 15/07/2020 to 17/07/2020

J. Noorul Ameen
Coordinator

ATTESTED

A. Baskar

DR. S. RAMABALAN, M.E., Ph.D.

A. Baskar PRINCIPAL Dr. M. Chinnadurai

E.G.S. Pillay Engineering College,
Nagapattinam - 611 002.

HOD

Nagapattinam (TN) Tamil Nadu.

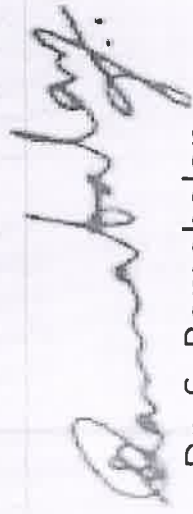

Dr. S. Ramabalan

Principal



**E.G.S.PILLAY ENGINEERING COLLEGE(AUTONOMOUS)
NAGAPATTINAM**

Affiliate to Anna University, Chennai | Approved by AICTE, New Delhi
An ISO 9001:2015 Certified Institutions Recognized by UGC 2(F) & 12(G)
Accredited by NBA(B.E-CSE/CIVIL/ECE/EEE/ MECH /B.Tech IT)
Accredited By NAAC with Grade 'A'



**DEPARTMENT OF COMPUTER SCIENCE
AND ENGINEERING**

**TWO DAYS ONLINE WORKSHOP ON "1704CS043
NETWORKING"**

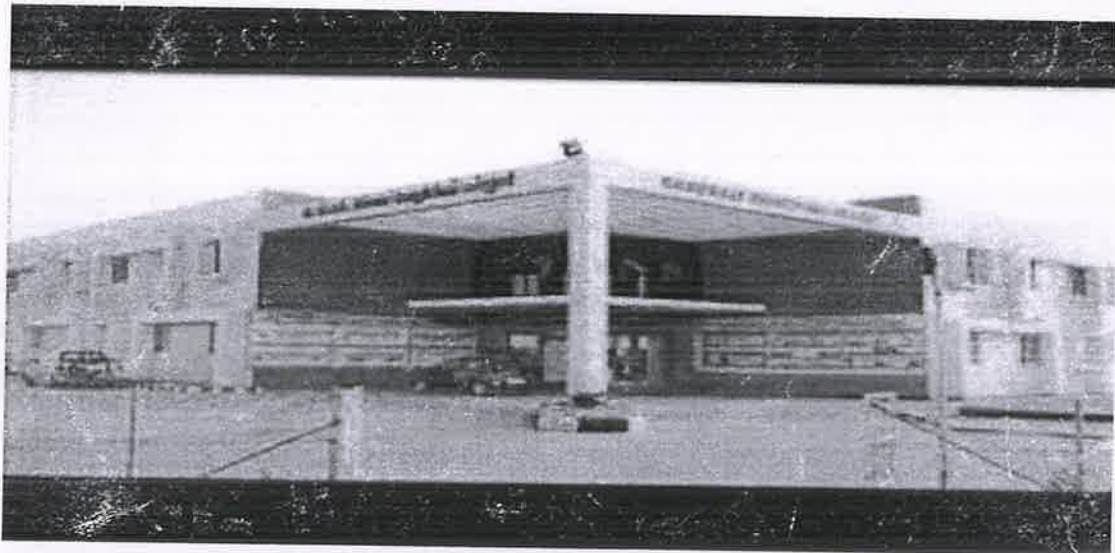

DATE: 12.09.2020 TO 13.09.2020

GOOGLE MEET LINK:

<https://meet.google.com/eaq-crhr-wzc>

Coordinator(s)

- 1. Dr. K. BALA SUBRAMANIAN**
Associate Professor/CSE
- 2. Mrs. B. RANJANI**
Assistant Professor/CSE
- 3. Dr. R. MANIVANNAN**
Associate Professor/CSE

Convenor

Dr.M.CHINNADURAI
Professor & Head / CSE

ATTESTED

Dr. S. RAMABALAN, M.E., Ph.D.,
PRINCIPAL
E.G.S. Pillay Engineering College,
Thethi, Nagore - 611 002.
Nagapattinam (Dt) Tamil Nadu.

**DEPARTMENT OF COMPUTER SCIENCE AND ENGINEERING
TWO DAYS ONLINE WORKSHOP ON "1704CS043 NETWORKING"**

TABLE OF CONTENTS

S.No	Content
1.	Requisition letter
2.	Poster
3.	Circular
4.	Program Schedule
5.	Report
6.	Participants Attendance
7.	Questions
8.	Assessment
9.	Impact Analysis
10.	CO's & PO Mapping
11.	Feedback
12.	Sample Certificates
13.	Sample Screenshots

HOD/CSE
Dr. M. CHINRIAJAN, M.E., Ph.D.,
Professor & HOD,
Dept. of Computer Science & Engg.,
E.G.S. Pillay Engineering College,
Nagapattinam.

ATTESTED

Dr. S. RAMABALAN, M.E., Ph.D.,
PRINCIPAL
E.G.S. Pillay Engineering College,
Thethi, Nagore - 611 002.
Nagapattinam (Dt) Tamil Nadu.

REQUISITION LETTER TO CONDUCT ONLINE WORKSHOP

From

Dr. R.Manivannan
Associate Professor/CSE
Department of CSE,
E.G.S Pillay Engineering College,
Nagapattinam.

To

The Principal,
E.G.S Pillay Engineering College,
Nagapattinam

Through

The HOD,
Department of CSE,
E.G.S Pillay Engineering College,
Nagapattinam.

Respected Sir,

Sub: Two days online workshop – Reg

We are happy to inform you that we have planned to organize two days' workshop on title "1704CS043 NETWORKING" for external participants from 12/09/2020 to 13/09/2020. Herewith, we enclose name list and session details. Kindly give permission for conducting the workshop.

Thanking you

yours faithfully,

[Dr. R.Manivannan]

PRINCIPAL

Dr. S. RAMABALAN, M.E., Ph.D.,
PRINCIPAL
E.G.S. PILLAY ENGINEERING COLLEGE
NAGAPATTINAM - 611 002.



Dr. M. Chidambaram, M.E., Ph.D.,
HoD/CSE, Professor & HOD,
Dept. of Computer Science & Engg.,
E.G.S. Pillay Engineering College,
Nagapattinam.

ATTESTED
ATTESTED

Dr. S. RAMABALAN, M.E., Ph.D.,
PRINCIPAL
E.G.S. PILLAY ENGINEERING COLLEGE,
NAGAPATTINAM - 611 002.

Nagapattinam (Dt) Tamil Nadu.



**E.G.S. PILLAY ENGINEERING COLLEGE
(AUTONOMOUS)
NAGAPATTINAM**

**DEPARTMENT OF COMPUTER SCIENCE AND
ENGINEERING**

organizing

**TWO DAYS ONLINE WORKSHOP
ON
1704CS043 - NETWORKING**

[DATE : 12.09.2020 - 13.09.2020]

GOOGLE MEET LINK

<https://meet.google.com/caq-cxhr-wzx>



**Dr.M.Aramudhan
PKIET**

SPEAKERS



**Dr.M.Chinnadurai
EGSPEC**

COORDINATORS

**Dr.K.Balasubramanian Dr.R.Manivannan
Mrs.B.Ranjani**

ATTESTED

**Dr. S. RAMABALAN, M.E., Ph.D.
PRINCIPAL**

E.G.S. Pillay Engineering College

Registration Form Link:

<https://forms.gle/T4HkQwwXAK48oChs3>

**E.G.S. PILLAY ENGINEERING COLLEGE (AUTONOMOUS),
NAGAPATTINAM
DEPARTMENT OF CSE**

CIRCULAR

Date: 09.09.2020

Warm greetings from E.G.S. Pillay Engineering College (An Autonomous Institutions, Affiliated to Anna university).

It's our immense pleasure to inform you that the Department of Computer Science and Engineering, E.G.S. Pillay Engineering College, Nagapattinam, organizing a two days workshop on 1704CS043 NETWORKING from 12.09.2020 to 13.09.2020. Hence, all the faculty members are asked to attend the workshop.

Interested persons are informed, to register for the workshop using the link given below

<https://forms.gle/T4HkQwwXAK48oChs3>



COORDINATORS

Dr. R. MANIVANNAN
Associate Professor
Department of Computer Science & Engineering
E.G.S. Pillay Engineering College,
Nagapattinam - 611 002.

HoD/CSE

Dr. M. C. SURAL, M.E., Ph.D.
Professor & HOD,
Dept. of Computer Science & Engg.,
E.G.S. Pillay Engineering College,
Nagapattinam.

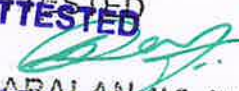
ATTESTED

ATTESTED
Dr. S. RAMABALAN, M.E., Ph.D.
PRINCIPAL
E.G.S. Pillay Engineering College,
Thelai, Nagore - 611 002,
Nagapattinam (Dt), Tamil Nadu.

E.G.S. PILLAY ENGINEERING COLLEGE (AUTONOMOUS)
DEPARTMENT OF COMPUTER SCIENCE AND ENGINEERING
PROGRAM SCHEDULE

S.No	Date	Session	Topics
1.	12.09.2020	FN	INTRODUCTION TO NETWORKING : Networking Connectivity, Network Extension, Network Topologies, OSI Layers – Physical layer, Data link Layer, Network Layer, Transport Layer and Networking Tools
		AN	NETWORKING DEVICES : Introduction about Networking Devices, Hub, Switch, Bridge, Router, Relays and Repeaters, Interfaces. Cable types – LAN cables, Fiber Cables. Maintenance and Monitoring, Trouble shooting Networking Devices.
2.	13.09.2020	FN	NETWORK DESIGN : IP Address Types – Class A, Class B, Class C and Class D, Switching Technology, Collision Domain, Broadcast Domain, Routing Technology. WAN TECHNOLOGY : Configure and verify PPP and MLPPP on WAN interfaces using local authentication, Describe WAN topology options - Point-to-point, Hub and spoke, Full mesh, Single vs dual-homed
		AN	IP ROUTING : RIP, IGRP, EIGRP, OSPF, Layer 2 Device configure, VLAN, Firewall, NAT. Assessment Test

Mds
HoD/CSE

Dr. M. CHINNADURAI, M.E., Ph.D.,
 Professor & HOD.
 Dept. of Computer Science & Engg.,
 E.G.S. Pillay Engineering College,
 Nagapattinam.

ATTESTED

[Signature]
DR. S. RAMABALAN, M.E., Ph.D.,
PRINCIPAL
 E.G.S. Pillay Engineering College,
 Thethi, Nagore-611002.
 Nagapattinam (Dt) Tamil Nadu.

E.G.S. PILLAY ENGINEERING COLLEGE (AUTONOMOUS)
DEPARTMENT OF COMPUTER SCIENCE AND ENGINEERING
“1704CS043 NETWORKING”

REPORT

Two days' workshop was successfully conducted on 12th and 13th September 2020 organized by Department of CSE, E.G.S. Pillay Engineering College, Nagapattinam. Total of 42 participants from the various colleges/institutions/universities of Nagapattinam had attended the workshop. Dr.S.Ramabalan, Principal and Dr.M.Chinnadurai, Professor & Head, CSE initially addressed the participants and gave a brief introduction about the workshop. Then, Mrs.B.Ranjani, Assistant Professor, CSE welcomes and emphasized on the importance of workshop and how to work and grow in the field of innovation lab problems and finally Dr.M.Aramudhan, Professor, PKIET and Dr.M.Chinnadurai, Professor & Head, CSE, EGSPEC, speakers of the workshop has ended their speech on a note to motivate all the participants.

ATTESTED

Dr. S. RAMABALAN, M.E., Ph.D.,
PRINCIPAL
E.G.S. Pillay Engineering College,
Thethi Nadore - 625 037
Nagapattinam, (Dt) Tamil Nadu.

REGISTRATION FORM

E.G.S. PILLAY ENGINEERING COLLEGE (AUTONOMOUS), NAGAPATTINAM

1704CS043 NETWORKING - TWO DAYS ONLINE WORKSHOP [12.09.20 & 13.09.20] -
REGISTRATION FORM

 ranjanf@egspegc.org (not shared) [Switch account](#) 

* Required

NAME *

Your answer

DEPARTMENT *

Your answer

COLLEGE NAME *

Your answer

LOCATION OF COLLEGE *

Your answer

LOCATION OF COLLEGE *

Your answer

EMAIL_ID *

Your answer

CONTACT NUMBER *

Your answer

Submit

Clear form

Never submit passwords through Google Forms.

Google Forms

ATTESTED



**Dr. S. RAMABALAN, M.E., Ph.D.,
PRINCIPAL**

E.G.S. Pillay Engineering College,
Thethi, Nagore - 611 002

Nagapattinam (Dt) Tamil Nadu

**DEPARTMENT OF COMPUTER SCIENCE AND ENGINEERING
TWO DAYS ONLINE WORKSHOP ON "1704CS043 NETWORKING"
PARTICIPANTS LIST**

S.No	Name	Designation	Dept	College
1.	Suresh V M	Assistant Professor	IT	EGSPEC
2.	Anand Babu R	Assistant Professor	IT	EGSPEC
3.	Padmanaban B	Professor	ECE	EGSPEC
4.	Sundar Raj A	Associate Professor	ECE	EGSPEC
5.	Kalaipoonguzhali V	Associate Professor	ECE	EGSPEC
6.	Elavarasi V	Assistant Professor	ECE	EGSPEC
7.	Nuthal Srinivasan M	Assistant Professor	ECE	EGSPEC
8.	Senthil Kumar T	Assistant Professor	ECE	EGSPEC
9.	Jim Hawkinson S	Assistant Professor	ECE	EGSPEC
10.	Asha Daisy B	Assistant Professor	MBA	EGSPEC
11.	Mallika C	Associate Professor	MCA	EGSPEC
12.	Selvaganapathy S	Assistant Professor	MCA	EGSPEC
13.	Surendar G	Assistant Professor	MECH	EGSPEC
14.	Manikandan B	Assistant Professor	MECH	EGSPEC
15.	Hari Narayanan G	Assistant Professor	MECH	EGSPEC
16.	Balasubramanian K	Assistant Professor	MECH	EGSPEC
17.	Markco M	Assistant Professor	CSE	EGSPEC
18.	Praveen Kumar S	Assistant Professor	CSE	EGSPEC
19.	Rajesh A	Assistant Professor	CSE	EGSPEC
20.	Vennila P	Assistant Professor	CSE	EGSPEC
21.	Rajakumaran M	Assistant Professor	CSE	EGSPEC
22.	Arulselvan G	Assistant Professor	CSE	EGSPEC
23.	Noorulameen J	Assistant Professor	CSE	EGSPEC
24.	Baskar A	Assistant Professor	CSE	EGSPEC
25.	Priyadharshini M	Assistant Professor	CSE	EGSPEC
26.	Subashri P	Assistant Professor	CSE	EGSPEC
27.	Venkatesan E	Assistant Professor	CIVIL	EGSPEC
28.	Sasirega N	Assistant Professor	CIVIL	EGSPEC
29.	Venkatramanan S	Assistant Professor	CIVIL	EGSPEC
30.	Padmavathy V	Assistant Professor	CSE	AVCCE
31.	Dr.J.Sudha	Associate Professor	CSE	AVCCE
32.	Dr.K.Krishnakumari	Associate Professor	CSE	AVCCE
33.	Mrs.R.Ramya	Assistant Professor	CSE	AVCCE
34.	Mr. K. Pazhanivel	Asst. Professor	CSE	AAMEC
35.	Mrs. G. Kalaiselvi	Asst. Professor	CSE	AAMEC
36.	Mr. G. Suresh	Assistant Professor	CSE	SINCET
37.	Subashini S	Assistant Professor	CSE	SINCET
38.	Mr. Akilan P	Assistant Professor	CSE	SINCET
39.	Mrs. Ambika R	Assistant Professor	CSE	SINCET
40.	Mr. Sathesh Kumar. K	Assistant Professor	CSE	UCET, THIRUKUVALAI
41.	Mr. Madhan. S	Assistant Professor	CSE	UCET, THIRUKUVALAI
42.	Dr. Sasikala. V	Assistant Professor	CSE	UCET, THIRUKUVALAI

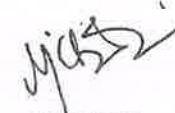
HOD/CSE
 Dr. M. CHINNAPPA, M.E., Ph.D.,
 Professor & HOD,
 Dept. of Computer Science & Engg.,
 E.G.S. Pillay Engineering College,
 Nagapattinam.

ATTESTED

ATTESTED
 Dr. S. RAMABALAN, M.E., Ph.D.,
 Dr. S. RAMABALAN, M.E., Ph.D.,
PRINCIPAL
 E.G.S. Pillay Engineering College,
 E.G.S. Pillay Engineering College,
 Nagapattinam (Dt) Tamil Nadu.
 Nagapattinam (Dt) Tamil Nadu.

1704CS043 - NETWORKING WORKSHOP MCQ TEST

Description

* Required

1. Name *

2. Designation *

3. Department *

4. College *

5. 1. The structure or format of data is called _____ *

1 point

Mark only one oval.

- Syntax
- Semantics
- Struct
- Formatting

ATTESTED

Dr. S. RAMABALAM, M.E., Ph.D.,
PRINCIPAL
E.G.S. Pillay Engineering College,
Theethi, Nagore - 611 002,
Nagapattinam (Dt) Tamil Nadu.

9. 5. Which network topology requires a central controller or hub? *

1 point

Mark only one oval.

- Star
- Mesh
- Ring
- Bus

10. 6. An interconnected collection of piconet is called _____ *

1 point

Mark only one oval.

- scatternet
- micronet
- mininet
- multinet

11. 7. Bluetooth uses _____ *

1 point

Mark only one oval.

- frequency hopping spread spectrum orthogonal
- frequency division multiplexing time division
- multiplexing
- channel division multiplexing

ATTESTED

Dr. S. RAMABALAN, M.E., Ph.D.,
PRINCIPAL
E.G.S. Pillay Engineering College,
Thethi, Nagore - 611 002.
Nagapattinam (Dt) Tamil Nadu.

This content is neither created nor endorsed by Google.

Google Forms

ATTESTED



Dr. S. RAMABALAN, M.E., Ph.D.,
PRINCIPAL

E.G.S. Pillay Engineering College,
Thethi, Nagore - 611 002,
Nagapattinam (Dt) Tamil Nadu.

1704CS043 - NETWORKING WORKSHOP MCQ TEST

Description

Name *

R.Ramya

Designation *

Assistant Professor

Department *

CSE

College *

AVCCE

ATTESTED



Dr. S. RAMABALAN, M.E., Ph.D.,
PRINCIPAL

E.G.S. Pillay Engineering College,
Thethi, Nagore - 611 002
Nagapattinam (Dt) Tamil Nadu.

7. Bluetooth uses _____ *

1 point

- frequency hopping spread spectrum orthogonal
- frequency division multiplexing time division
- multiplexing
- channel division multiplexing

8. Which NetWare protocol works on layer 3—network layer—of the OSI model? Which NetWare protocol works on layer 3—network layer—of the OSI model?

* 1 point

- IPX
- NCP
- SPX
- NETBios

9. Working with the WAN typically entails – *

1 point

- ATM
- Satellite
- Frame delay
- All of these

ATTESTED

Dr. S. RAMABALAN, M.E., Ph.D.,
PRINCIPAL

E.G.S. Pillay Engineering College,
Thechi, Nagore - 611 002,
Nagapattinam (Dt) Tamil Nadu.

10. Two computers C1 and C2 are configured as follows. C1 has IP address 203.197.2.53 * 1 point and netmask 255.255.128.0. C2 has IP address 203.197.75.201 and netmask 255.255.192.0. which one of the following statements is true?

- C1 and C2 both assume they are on the same network
- C2 assumes C1 is on same network, but C1 assumes C2 is on a different network C1
- assumes C2 is on same network, but C2 assumes C1 is on a different network C1 and C2
- both assume they are on different networks.

This form was created inside of E.G.S. Pillay Engineering College.

Google Forms

ATTESTED

Dr. S. RAMABALAN, M.E., Ph.D.,
PRINCIPAL

E.G.S. Pillay Engineering College,
Thethi, Nagore - 611 002,
Nagapattinam (Dt) Tamil Nadu.

**E.G.S.PILLAY ENGINEERING COLLEGE(AUTONOMOUS), NAGAPATTINAM
DEPARTMENT OF COMPUTER SCIENCE AND ENGINEERING**

TWO DAYS ONLINE WORKSHOP ON "NETWORKING"

ASSESSMENT MARK STATEMENT

S.No	Name	Total Marks
1.	Suresh V M	09
2.	Anand Babu R	10
3.	Padmanaban B	10
4.	Sundar Raj A	10
5.	Kalaipoonguzhali V	10
6.	Elavarasi V	09
7.	Nuthal Srinivasan M	10
8.	Senthil Kumar T	10
9.	Jim Hawkinson S	10
10.	Asha Daisy B	10
11.	Mallika C	10
12.	Selvaganapathy S	10
13.	Surendar G	10
14.	Manikandan B	09
15.	Hari Narayanan G	09
16.	Balasubramanian K	10
17.	Markco M	09
18.	Praveen Kumar S	10
19.	Rajesh A	10
20.	Vennila P	09
21.	Rajakumaran M	10
22.	Arulselvan G	10
23.	Noorulameen J	10
24.	Baskar A	10
25.	Priyadharshini M	09
26.	Subashri P	10
27.	Venkatesan E	09
28.	Sasirega N	10
29.	Venkatramanan S	10
30.	Padmavathy V	10
31.	Dr.J.Sudha	10
32.	Dr.K.Krishnakumari	10
33.	Mrs.R.Ramya	09
34.	Mr. K. Pazhanivel	10
35.	Mrs. G. Kalaiselvi	10
36.	Mr. G. Suresh	10
37.	Subashini S	09
38.	Mr. Akilan P	09
39.	Mrs. Ambika R	10
40.	Mr. Satheesh Kumar. K	10
41.	Mr. Madhan. S	10
42.	Dr. Sasikala. V	09

ATTESTED

Dr. S. RAMABALAN, M.E., Ph.D.,

PRINCIPAL

**E.G.S. Pillay Engineering College,
Thethi, Nagore - 611-002.**

Nagapattinam (Dt) Tamil Nadu.

HOD/CSE

**Dr. M. CHINNADURAI, M.E., Ph.D.,
Professor & HOD.**

**Dept. of Computer Science & Engg.,
E.G.S. Pillay Engineering College,
Nagapattinam.**

**E.G.S.PILLAY ENGINEERING COLLEGE(AUTONOMOUS), NAGAPATTINAM
DEPARTMENT OF COMPUTER SCIENCE AND ENGINEERING**

TWO DAYS ONLINE WORKSHOP ON “NETWORKING”

Assessment Impact Analysis

S.No	Name	Q1	Q2	Q3	Q4	Q5	Q6	Q7	Q8	Q9	Q10
1.	Suresh V M	1	1	1	1	1	1	1	0	1	1
2.	Anand Babu R	1	1	1	1	1	1	1	1	1	1
3.	Padmanaban B	1	1	1	1	1	1	1	1	1	1
4.	Sundar Raj A	1	1	1	1	1	1	1	1	1	1
5.	Kalaiipoonguzhali V	1	1	1	1	1	1	1	1	1	1
6.	Elavarasi V	1	1	1	1	1	1	1	1	1	0
7.	Nuthal Srinivasan M	1	1	1	1	1	1	1	1	1	1
8.	Senthil Kumar T	1	1	1	1	1	1	1	1	1	1
9.	Jim Hawkinson S	1	1	1	1	1	1	1	1	1	1
10.	Asha Daisy B	1	1	1	1	1	1	1	1	1	1
11.	Mallika C	1	1	1	1	1	1	1	1	1	1
12.	Selvaganapathy S	1	1	1	1	1	1	1	1	1	1
13.	Surendar G	1	1	1	1	1	1	1	1	1	1
14.	Manikandan B	1	1	1	1	1	1	1	1	0	1
15.	Hari Narayanan G	1	1	1	1	1	1	1	1	1	0
16.	Balasubramanian K	1	1	1	1	1	1	1	1	1	1
17.	Markco M	1	0	1	1	1	1	1	1	1	1
18.	Praveen Kumar S	1	1	1	1	1	1	1	1	1	1
19.	Rajesh A	1	1	1	1	1	1	1	1	1	1
20.	Vennila P	1	0	1	1	1	1	1	1	1	1
21.	Rajakumaran M	1	1	1	1	1	1	1	1	1	1
22.	Arulselvan G	1	1	1	1	1	1	1	1	1	1
23.	Noorulameen J	1	1	1	1	1	1	1	1	1	1
24.	Baskar A	1	1	1	1	1	1	1	1	1	1
25.	Priyadharshini M	1	1	1	1	1	1	1	0	1	1
26.	Subashri P	1	1	1	1	1	1	1	1	1	1
27.	Venkatesan E	1	1	1	1	1	1	1	1	1	0
28.	Sasirega N	1	1	1	1	1	1	1	1	1	1
29.	Venkatramanan S	1	1	1	1	1	1	1	1	1	1
30.	Padmavathy V	1	1	1	1	1	1	1	1	1	1
31.	Dr.J.Sudha	1	1	1	1	1	1	1	1	1	1
32.	Dr.K.Krishnakumari	1	1	1	1	1	1	1	1	1	1
33.	Mrs.R.Ramya	1	1	1	1	1	1	1	1	1	0
34.	Mr. K. Pazhanivel	1	1	1	1	1	1	1	1	1	1
35.	Mrs. G. Kalaiselvi	1	1	1	1	1	1	1	1	1	1
36.	Mr. G. Suresh	1	1	1	1	1	1	1	1	1	1
37.	Subashini S	1	1	1	1	1	0	1	1	1	1
38.	Mr. Akilan P	1	0	1	1	1	1	1	1	1	1
39.	Mrs. Ambika R	1	1	1	1	1	1	1	1	1	1
40.	Mr. Sathesh Kumar. K	1	1	1	1	1	1	1	1	1	1
41.	Mr. Madhan. S	1	1	1	1	1	1	1	1	1	1
42.	Dr. Sasikala. V	1	0	1	1	1	1	1	1	1	1
	TOTAL	42	38	42	42	42	41	42	40	41	38
	ASSESSMENT	100	90.48	100	100	100	97.62	100	95.24	97.62	90.48
	LEVEL OF ASSESSMENT	3 (S)	3 (S)	3 (S)	3 (S)	3 (S)	3 (S)	3 (S)	3 (S)	3 (S)	3 (S)

Attainment level calculation	
>=70%-79%	1 (L)
>=80%-89%	2 (M)
>=90%	3 (S)

ATTENDED

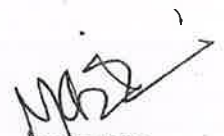
Dr. S. RAMABALAN, M.E., Ph.D.,
PRINCIPAL
E.G.S. Pillay Engineering College,
 The Electronic Complex, 16/10/2021
 Nagapattinam (Dist) Tamil Nadu.



HOD/CSE
Dr. M. CHINNADURAI, M.E., Ph.D.,
 Professor & HOD,
 Dept. of Computer Science & Engg.,
 E.G.S. Pillay Engineering College,
 Nagapattinam.

COURSE OUTCOMES CO-PO –PSO MAPPING

- 1.. Build an understanding of the fundamental concepts of computer networking.
2. Familiarize the student with the basic taxonomy and terminology of the computer networking area.
3. Introduce the student to advanced networking concepts, preparing the student for entry Advanced courses in computer networking.
4. Independently understand basic computer network technology.
5. Identify the different types of network topologies and protocols.

Course Outcomes	PO1	PO2	PO3	PO4	PO5	PO6	PO7	PO8	PO9	P10	PO11	PO12	PSO 1	PSO 2
CO1	-	-	3	3	3	-	-	-	-	2	-	2	3	-
CO2	-	-	3	3	3	-	-	-	-	2	-	2	3	-
CO3	-	-	3	3	3	-	-	-	-	2	-	2	3	-
CO4	-	-	3	3	3	-	-	-	-	2	-	2	3	-
CO5	-	-	3	3	3	-	-	-	-	2	-	2	3	-
CO6	-	-	3	3	3	-	-	-	-	2	-	2	3	-
CO7	-	-	3	3	3	-	-	-	-	2	-	2	3	-
Average	-	-	3	3	3	-	-	-	-	2	-	2	3	-

1. Slight (Low) 2. Moderate (Medium) 3. Substantial (High) “-“No Correlation

HOD/CSE, M.E., Ph.D.,
 Professor & HOD.
 Dept. of Computer Science & Engg.,
 E.G.S. Pillay Engineering College,
 Nagapattinam.

ATTESTED

Dr. S. RAMABALAN, M.E., Ph.D.,
PRINCIPAL
 E.G.S. Pillay Engineering College,
 Thethi, Nagore - 611 002,
 Nagapattinam (Dt) Tamil Nadu.

E.G.S. PILLAY ENGINEERING COLLEGE (AUTONOMOUS), NAGAPATTINAM

1704CS043 NETWORKING - TWO DAYS ONLINE WORKSHOP [12.09.20 & 13.09.20] -
FEEDBACK FORM

* Required

1. Name *

2. Designation *

3. Department *

4. College *

ATTESTED

Dr. S. RAMABALAN, M.E., Ph.D.,
PRINCIPAL

E.G.S. Pillay Engineering College,
Thethi. Nagore - 611 002.
Nagapattinam (Dt) Tamil Nadu.

This content is neither created nor endorsed by Google.

Google Forms

ATTESTED



Dr. S. RAMABALAN, M.E., Ph.D.,
PRINCIPAL

E.G.S. Pillay Engineering College,
Thethi, Nagore - 611 002,
Nagapattinam (Dt) Tamil Nadu.

E.G.S. PILLAY ENGINEERING COLLEGE (AUTONOMOUS), NAGAPATTINAM

1704CS043 NETWORKING - TWO DAYS ONLINE WORKSHOP [12.09.20 & 13.09.20] - FEEDBACK FORM

Name *

SURESH VM

Designation *

Assistant Professor

Department *

IT

College *

EGSPEC

ATTESTED

Dr. S. RAMABALAN, M.E., Ph.D.,
PRINCIPAL

E.G.S. Pillay Engineering College,
Thethi, Nagore - 611 002.
Nagapattinam (Dt) Tamil Nadu.

DEPARTMENT OF COMPUTER SCIENCE AND ENGINEERING

TWO DAYS ONLINE WORKSHOP ON "NETWORKING"

FEEDBACK ANALYSIS REPORT

S.No	Name	Covered Useful Material	Useful Visual Aids and Handouts	Instructor's Knowledge	Instructor Responded Well to Questions	Overall, how would you evaluate this training session?
43	Suresh V M	1	1	1	1	1
44	Anand Babu R	1	1	1	1	1
45	Padmanaban B	1	1	1	1	1
46	Sundar Raj A	1	1	1	1	1
47	Kalaipoonguzhali V	1	1	1	1	1
48	Elavarasi V	1	1	1	1	1
49	Nuthal Srinivasan M	1	1	1	1	1
50	Senthil Kumar T	1	1	1	1	1
51	Jim Hawkins S	1	1	1	1	1
52	John Daisy B	1	1	1	1	1
53	Mallika C	1	1	1	1	1
54	Selvaganapathy S	1	1	1	1	1
55	Surender G	1	1	1	1	1
56	Manikandan B	1	1	1	1	1
57	Hari Narayanan G	1	1	1	1	1
58	Rajasubramanian K	1	1	1	1	1
59	Marico M	1	0	1	1	1
60	Bowen Kumar S	1	1	1	1	1
61	Rajesh V	1	1	1	1	1
62	Venkata C	1	0	1	1	1
63	Rajakumaran M	1	1	1	1	1
64	Arulselvan G	1	1	1	1	1
65	Noorulameen J	1	1	1	1	1
66	Baskar A	1	1	1	1	1
67	Priyadharshini M	1	1	1	1	1
68	Subashri P	1	1	1	1	1
69	Venkatesan E	1	1	1	1	1
70	Sasirega N	1	1	1	1	1
71	Venkatramanan S	1	1	1	1	1
72	Padmavathy V	1	1	1	1	1
73	Dr J.Sudha	1	1	1	1	1
74	Dr.K.Krishnakumari	1	1	1	1	1
75	Mrs R.Ramya	1	1	1	1	1
76	Mr. K. Pazhanivel	1	1	1	1	1
77	Mrs. G. Kalaselti	1	1	1	1	1
78	Mr. G. Suresh	1	1	1	1	1
79	Subashini S	1	1	1	1	1
80	Mr. Akilan P	1	0	1	1	1
81	Mrs. Ambika R	1	1	1	1	1
82	Mr. Balaji Kumar K	1	1	1	1	1
83	Mr. Madhan S	1	1	1	1	1
84	Dr. Sankaranarayanan	1	0	1	1	1
	TOTAL	208	201	194	201	207
	ASSESSMENT	3.0	2.9	2.8	2.9	3.0
	LEVEL OF ASSESSMENT	3 (S)	3 (S)	3 (S)	3 (S)	3 (S)

Attainment Level 0.5-1 = L, 1.5 - 2 = M, 2.5 - 3 = S

HOD/CSE
 Dr. M. CHINNADURAI, M.E., Ph.D.,
 Professor & HOD,
 Dept. of Computer Science & Engg.,
 E.G.S. Pillay Engineering College,
 Nagapattinam.

ATTESTED

 Dr. S. RAMABALAN, M.E., PH.D.,
 PRINCIPAL,
 E.G.S. Pillay Engineering College,
 Thethi, Nagore- 641002,
 Nagapattinam, Tamil Nadu.

E.G.S. PILLAY ENGINEERING COLLEGE (AUTONOMOUS)

Accredited by NBA/B.E-CSE.EEE.EEE.Mech., Civil/B.Tech-IT)
Affiliated to Anna University, Chennai | Approved by AICTE, New Delhi
principal@egspec.org | enquires@egspec.org



Accredited by NAAC with Grade 'A'
An ISO 9001:2015 Certified Institution | Recognised by UGC 2(F) & 12(B)
+91-4365-2511121+91-4365-251114

Counselling Code: 3806 Old Nagore Road, Thethi, Nagapattinam - 611002, Tamil Nadu NIRF Engineering Ranking top 200 in India

CERTIFICATE OF PARTICIPATION

This is to certify that

Padmarathi D

A.V.C College of Engineering

has participated in the Two days workshop on "1704CS043 NETWORKING" organized by the Department of Computer Science and Engineering, E.G.S Pillay Engineering College, Nagapattinam through online pedagogy on 12/09/2020 & 13/09/2020.

B. Rajan

Coordinator

Nidha

ATTESTED

Head of Department

Principal

Dr. S. RAMAPALAN, M.E., Ph.D.,
PRINCIPAL
E.G.S. Pillay Engineering College,
Thethi, Nagore - 611 002,
Nagapattinam (Dt) Tamil Nadu.

E.G.S. PILLAY ENGINEERING COLLEGE (AUTONOMOUS)

Accredited by NBA/B.E-CSE.EEE.Mech., Civil/B.Tech-IT)
Affiliated to Anna University, Chennai | Approved by AICTE, New Delhi
principal@egspec.org | enquires@egspec.org



Accredited by NAAC with Grade 'A'
An ISO 9001:2015 Certified Institution | Recognised by UGC 2(f) & 12(B)
+91-4365-2511121+91-4365-2511114

Counselling Code: 3806 Old Nagore Road, Thethi, Nagapattinam - 611002, Tamil Nadu NIRF Engineering Ranking top 200 in India

CERTIFICATE OF PARTICIPATION

This is to certify that

Vennila S

E.G.S.Pillay Engineering College

has participated in the Two days workshop on "1704CS043 NETWORKING" organized by the Department of Computer Science and Engineering, E.G.S Pillay Engineering College, Nagapattinam through online pedagogy on 12/09/2020 & 13/09/2020.

6/Jan/21
B. Rajan
B. Rajan
PRINCIPAL

6/Jan/21
B. Rajan
PRINCIPAL

N. S. Ramabalan
N. S. Ramabalan
PRINCIPAL

N. S. Ramabalan
N. S. Ramabalan, M.E., Ph.D.,
PRINCIPAL

E.G.S. Pillay Engineering College,
Thethi, Nagore - 611 002,
Nagapattinam (Dt) Tamil Nadu.

N. S. Ramabalan
Principal

E.G.S. Pillay Engineering College,
Thethi, Nagore - 611 002,
Nagapattinam (Dt) Tamil Nadu.

ATTESTED

Dr.M.Aramudhan PKIET is presenting

Advantage of Networking

Networking Enables:

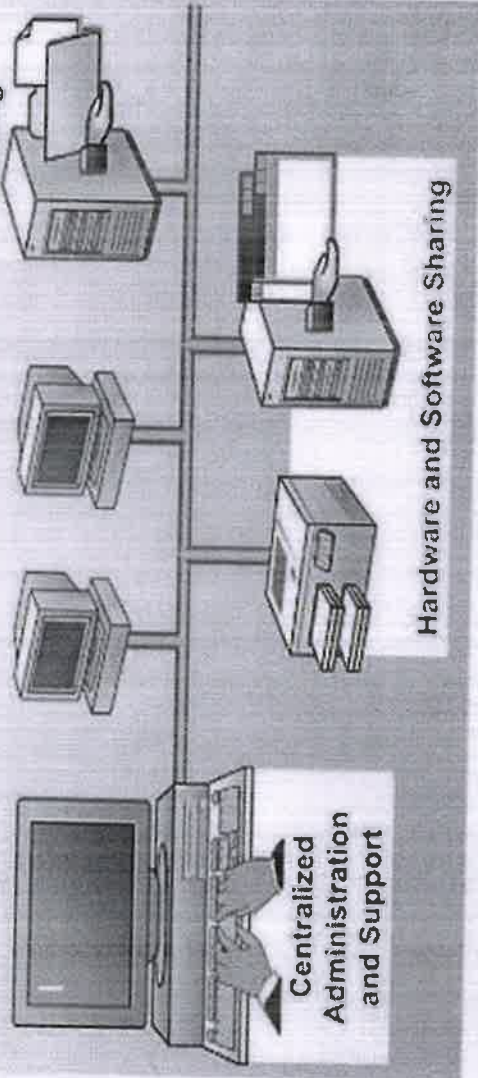

5

11:08 AM | eaq-crhr-wzc

www.screencapture.com is sharing your screen and audio. Stop sharing Hide

Dr.M.Aramudhan PK.	Ranjani B	Subashri P
Chinnadurai M	Rajesh A	Manivannan R
G. Kalaiselvi	31 others	You

S. Ramabalan
Dr. S. RAMABALAN, M.E., Ph.D.,
PRINCIPAL
 E.G.S. Pillay Engineering College,
 Thethi, Nagore - 611 002,
 Nagapattinam (Dt) Tamil Nadu.

11:08

A	B	C	D	E	F	G	H	I	J	K
Timestamp	Score	Name	Designation	Department	College	1. The structure or format 2. A	3. The HTTP request mes.4. The values GET, POST.5. Which net			
9/13/2020 16:37:46		9/10 Suresh VM	Assistant Professor	IT	E.G.S.Pillay Engineering Syntax	Medun	Third	Request line	Star	
9/13/2020 22:56:41		10/10 Padminaban E	Professor	ECE	E.G.S.Pillay Engineering Syntax	Medun	Third	Request line	Star	
9/13/2020 16:46:24		10/10 Kalai poonguzhal Y	Associate Professor	ECE	EGSPEC	Medun	Third	Request line	Star	
9/13/2020 16:48:57		9/10 P. Hyderabadini M	Assistant Professor	CSE	EGSPEC	Medun	Third	Request line	Star	
9/13/2020 16:51:04		10/10 P. adminaathiy V	Assistant Professor	Computer Science and Engin	AVCOE	Medun	Third	Request line	Star	
9/14/2020 16:36:14		9/10 R. Ramya	Assistant Professor	CSE	AVCOE	Medun	Third	Request line	Star	
9/14/2020 16:37:28		10/10 G. Suresh	Assistant Professor	CSE	Sir Isaac Newton College Syntax	Medun	Third	Request line	Star	
9/14/2020 16:36:59		9/10 S. Subashini S	Assistant Professor	Computer science and Engin	university College, Thiruk Syntax	Medun	Third	Request line	Star	
9/13/2020 16:58:15		10/10 S. adithesh Kumar k	Assistant Professor	Cse	UCET, Tirukuvai	Path	Third	Request line	Star	
9/13/2020 16:57:21		9/10 Dr.S. Saikathala	Assistant Professor	CSE	e G.S.Pillay Engineering Syntax	Medun	Third	Request line	Star	
9/13/2020 16:58:32		10/10 S. Saitega N	Assistant Professor	cnl	EGSPEC	Medun	Third	Request line	Star	
9/13/2020 16:59:30		10/10 Jim Hawkinson S	Assistant Professor	ECE	EGSPEC	Medun	Third	Request line	Star	
9/13/2020 17:16:40		10/10 Asha Daisy B	Assistant Professor	MBA	EGSPEC	Medun	Third	Request line	Star	
9/13/2020 17:01:50		10/10 Selvamaneopathy S	Assistant Professor	MCA	E.G.S.Pillay Engineering Syntax	Medun	Third	Request line	Star	
9/13/2020 17:16:45		10/10 Rajesh A	Assistant Professor	CSE	EGSPEC	Medun	Third	Request line	Star	
9/13/2020 17:17:58		10/10 Noorul Ameen J	Assistant Professor	Computer science and Engin	E.G.S.Pillay Engineering Syntax	Medun	Third	Request line	Star	
9/13/2020 17:17:03		9/10 Venkatesan E	Assistant Professor	CIVIL	E.G.S.Pillay Engineering Syntax	Medun	Third	Request line	Star	
9/13/2020 17:06:07		10/10 Venkataramanan S	Assistant Professor	CIVIL	EGSPEC	Medun	Third	Request line	Star	
9/13/2020 17:07:23		10/10 Dr.J. Sudha	Associate Professor	CSE	AVCOE	Medun	Third	Request line	Star	
9/13/2020 17:08:37		10/10 Dr.K. Krishnakumari	Associate Professor	Computer Science & Engin	A.V.C. College of Engin	Medun	Third	Request line	Star	
9/13/2020 17:08:41		10/10 G. Kalaseni	Assistant Professor	CSE	A.A.M.E.C	Medun	Third	Request line	Star	
9/13/2020 17:56:31		9/10 Akilan P	Assistant Professor	CSE	SINCE T	Prdood	Third	Request line	Star	
9/13/2020 17:11:13		10/10 Anand Babu R	Assistant Professor	IT	EGSPEC	Medun	Third	Request line	Star	
9/13/2020 17:56:21		9/10 Elaverasi V	Assistant Professor	ECE	E.G.S.Pillay Engineering Syntax	Medun	Third	Request line	Star	
9/13/2020 18:57:11		9/10 Marihandan B	Assistant Professor	MECH	EGSPEC	Medun	Third	Request line	Star	
9/13/2020 17:56:02		10/10 Balasubramanian K	Associate Professor	MECH	EGSPEC	Medun	Third	Request line	Star	
9/13/2020 18:57:24		10/10 Ambika R	Assistant Professor	CSE	SINCE T	Medun	Third	Request line	Star	
9/13/2020 17:16:06		9/10 Vernila P	Assistant Professor	CSE	EGSPEC	Prdood	Third	Request line	Star	

Dr. S. RAMABALAN, M.E., Ph.D.,
PRINCIPAL
 E.G.S. Pillay Engineering College,
 Thethi, Nagore - 611 002.

Questions Responses **42** Settings Total points: 10

42 responses

View in Sheets

Accepting responses

Summary

Question

Individual

Insights

Average 9.71 / 10 points

Median 10 / 10 points

Range 9 - 10 points

Total points distribution

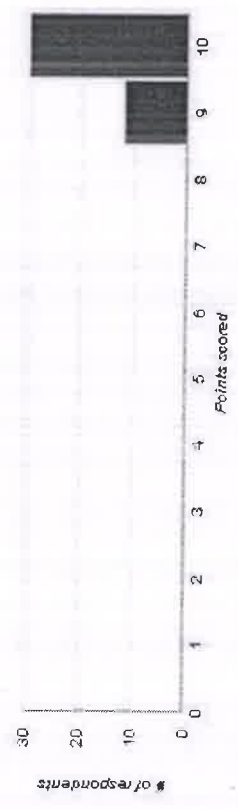

Name
42 responses



Dr. S. RAWABALAN, M.E., Ph.D.,
PRINCIPAL

E.G.S. Pillay Engineering College,
Thethi, Nagore - 611 002.
Mangalore, (D) Taluk, Madh.

E.G.S. PILLAY ENGINEERING COLLEGE (AUTONOMOUS), NAGAPATTINAM

1704CS043 NETWORKING - TWO DAYS ONLINE WORKSHOP [12.09.20 & 13.09.20] - FEEDBACK FORM

Name Short answer

Short answer text

Required

Designation *

Short answer text

Department *

Short answer text

ATTESTED 

DR. C. RAVI BABAN, M.E., Ph.D.,
PRINCIPAL
E.G.S. Pillay Engineering College,
Thattai Nagar - 611 602
Nagapattinam (Dt) Tamil Nadu.

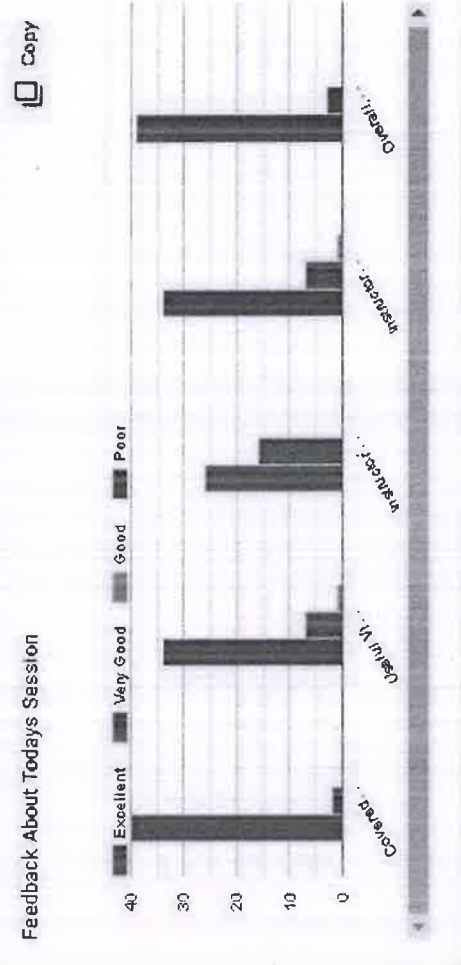

Any other Suggestions

42 responses

Feedback	Response
nil	
no	
good	
No	

ATTESTED

PRINCIPAL
E.G.S. Pillay Engineering College,
 Thottai, Nagore - 611 002.
 Nagapattinam (Dt) Thanil Nadu.

Or. S. RAMABALAN, M.E., PH.D.

E.G.S PILLAY ENGINEERING COLLEGE

Nagapattinam – 611 002.Tamil Nadu, India.

(An Autonomous Institution, Affiliated to Anna University, Chennai.)

DEPARTMENT OF INFORMATION TECHNOLOGY

FDP ON INDUSTRY 4.0

(DIGITIZATION AND OPPORTUNITIES FOR SUSTAINABILITY)

S.NO	CONTENT
1.	Brochure
2.	Circular
3.	Permission Letter
4.	Schedule
5.	Resource Person Profile
6.	Attendance
7.	Certificate
8.	Feedback
9.	Report

R. Srinivasan - *Arumugam*

Coordinators

Dr. S. Manikandan
Dr. S. MANIKANDAN
Associate Professor and Head
Chairman - Board of Studies
Department of Information Technology
E.G.S. Pillay Engineering College
Nagapattinam - 611 002.

ATTESTED
Dr. S. Ramabalan
Dr. S. RAMABALAN, M.E., Ph.D.,
PRINCIPAL
E.G.S. Pillay Engineering College,
Thethi, Nagore - 611 002.
Nagapattinam (Dt) Tamil Nadu.

IT-6

E.G.S. PILLAY ENGINEERING COLLEGE (AUTONOMOUS)

Accredited by NBA(B.E-CSE,ECE,EEE,Mech,Civil/B.Tech-IT)
Affiliated to Anna University, Chennai | Approved by AICTE, New Delhi



Accredited by NAAC with Grade 'A'
An ISO 9001:2015 Certified Institution | Recognised by UGC 2(F & 12(B)

principal@egspec.org | enquires@egspec.org

+91-4365-251112 | +91-4365-251114

DEPARTMENT OF INFORMATION TECHNOLOGY

Organizes the Faculty Development Programme on

INDUSTRY 4.0

(DIGITIZATION AND OPPORTUNITIES FOR SUSTAINABILITY)

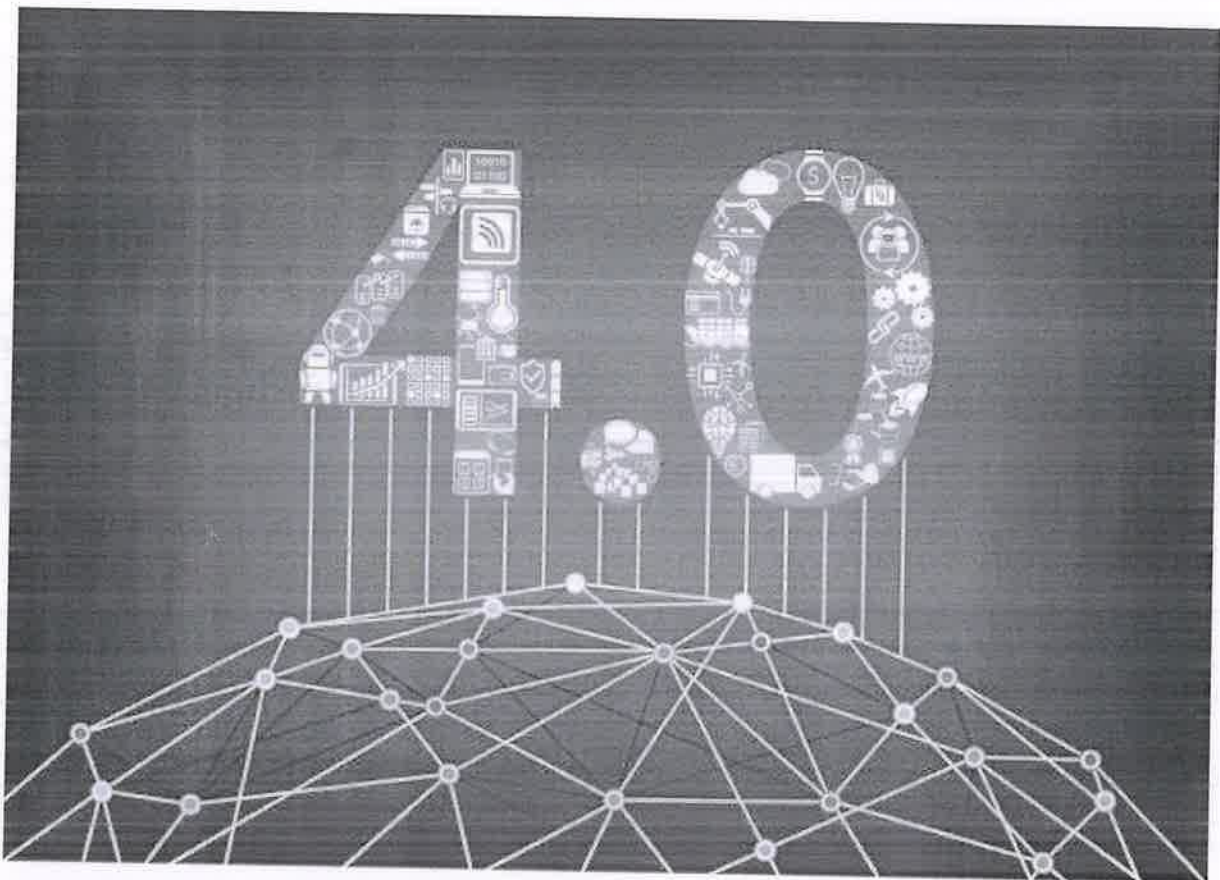

Coordinators

ATTESTED 

Dr. S. RAMABALAN, M.E., Ph.D.,
PRINCIPAL
E.G.S. PILLAY ENGINEERING COLLEGE
NAGAPATTINAM - 611 002.

K.Nagalakshmi
R.Lavanya

Programme Content:

- Introduction to industry 4.0.
- Industry 4.0 modality : Need and Challenges
- Adoption of Industry 4.0 in various sectors
- Industry 4.0 implementation across countries
- Innovative teaching learning method using augmented reality technology- an industry 4.0 initiative.
- Key trending technologies and their use cases for industry 4.0-- AR/VR, 5G, blockchain, etc.
- Conclusion, implications, and future directions
- Stress management, meditation and human values and ethics.
- Hands-on sessions.

Resource Person

1. **Jaya Sakthi K, Senior IoT Architect,**
Menba Technologies,
Chennai.
2. **Saravanan G, IIoT Expert,**
Larson and Toubro Info Tech,
Chennai.

Course Coordinator

- Mrs. K. Nagalakshmi**
Assistant Professor
- Mrs. R.Lavanya**
Assistant Professor

ATTESTED



Dr. S. RAMABALAN, M.E., Ph.D.,
PRINCIPAL
E.G.S. Pillay Engineering College,
Thethi, Nagore - 611 002.
Nagapattinam (Dt) Tamil Nadu.

Faculty Development Programme

For (EEE, ECE, MECH, CSE, CSBS, IT, CIVIL, MCA, MBA)

On

Industry 4.0 – Digitalization and Opportunities

For Sustainability



28/04/2021 - 30/04/2021



09:00 am to 4:30 pm

Organized by

Department of Information Technology

(Accredited by NBA)

E.G.S PILLAY ENGINEERING COLLEGE

(AUTONOMOUS)

Nagapattinam – 611 002

Affiliated to Anna University ,Chennai

Approved by AICTE ,New Delhi

Accredited by NAAC with GRADE 'A'



About The Institution

E. G. S. Pillay Engineering College (Autonomous) is one of the pioneering non-grant engineering Colleges in the State. It was established by the G.S. Pillay & Sons Educational & Charitable Trust, Nagapattinam in the year 1995 with the sanction of the Government of Tamil Nadu, approval of the All-India Council for Technical Education, New Delhi and affiliated to Anna University, Chennai. The college has accredited by NAAC with 'A' Grade and all the UG programmes are accredited by NBA. The College has earned the reputation of being one of the most preferred colleges by the students and parents all these years. Known for its excellent infrastructure and facilities for learning, the outstanding non-grant engineering college has registered impressive performance consistently. A gate-way to success, the college has now set on long-range planning to enlarge and enrich its programs and activities to empower the youth who aspire to become successful Engineers, Scientists and Managers.

Vision

Envisioned to transform out institution into a "Global Centre of Academic Excellence"

Mission

- ✓ To provide world class education to the students and to bring out their inherent talents
- ✓ To establish state-of-the-art facilities and resource required to achieve excellence in teaching-learning and supplementary processes
- ✓ To recruit competent faculty and staff and to provide opportunity to upgrade their knowledge and skills
- ✓ To have regular interaction with the industries in the area of R&D and offer consultancy, training and testing services.
- ✓ To establish centers of excellence in the emerging areas of research
- ✓ To offer continuing education and non-formal vocational education programs beneficial to the society.

Department Vision

To produce globally competent information technologist and to inculcate values of leadership and research qualities in them.

Department Mission

- ✓ To provide a high quality education to the students by our competent faculty members, effective teaching learning process and value-added courses
- ✓ To create a centers of excellence by interacting with industries for better employability and to contribute to the society through consultancy and R&D works
- ✓ To improve the soft skills, interpersonal skills, ethical behavior and communication skill of students by involving team works and technical event.

Objective of the FDP

The main objective of conducting FDP on Industry 4.0 is to fill the gap between industry and academics and to transfer knowledge by imparting quality training (Both theory and hands-on) to participants.

Course Overview

The fourth industrial revolution, sometimes known as Industry 4.0, and the underlying digital transformation are both advancing exponentially. Regarding the potential for sustainability that the digital revolution may provide, the public is still upbeat. Analysis reveals that the more immediate effects of Industry 4.0 likely to be those related to economic sustainability, such as production efficiency and business model innovation. The sustainability of energy, the reduction of hazardous emissions, and the enhancement of social sustainability are additional remote socio-environmental sustainability functions.

ATTESTED
sustainability
ME, Ph.D.

DR. S. RAMABALAM
PRINCIPAL
E.G.S. Pillay Engineering College,
Thethi, Nagore - 611 002.
Nagapattinam (Dt) Tamil Nadu.

E.G.S PILLAY ENGINEERING COLLEGE

Nagapattinam – 611 002.Tamil Nadu, India.

(An Autonomous Institution, Affiliated to Anna University, Chennai.)

DEPARTMENT OF INFORMATION TECHNOLOGY

CIRCULAR

EGSPEC/IT/APR 2021

25/04/2021

Greetings from the department of Information Technology. We are going to organize “ Three day Faculty development programme on Industry 4.0 digitization and opportunities for sustainability” on 28/04/2021 to 30/04/2021. In this regard all the faculty members are asked to attend the FDP and get benefitted.



HOD/IT

Dr. S. MANIKANDAN
Associate Professor and Head
Chairman - Board of Studies
Department of Information Technology
E.G.S. Pillay Engineering College
Nagapattinam - 611 002.

ATTESTED

Dr. S. RAMABALAN, M.E., Ph.D.,
PRINCIPAL
E.G.S. Pillay Engineering College,
Thethi, Nagore - 611 002
Nagapattinam (Ut) T.

From

K.Nagalakshmi ,R.Lavanya
Associate Professor, Assistant Professor
Coordinator of FDP
Department of Information Technology
E.G.S. Pillay Engineering College
Nagapattinam-611002

To

The principal
E.G.S. Pillay Engineering College
Nagapattinam-611002

Through the HOD

Respected Sir,

Sub: Requesting to conduct two days faculty development programme -reg

We are happy to inform you that we plan to conduct a Three-day faculty development programme on "Industry 4.0 digitalization and opportunities for sustainability" from 28/04/2021 to 30/04/2021. This programme will be useful for EEE, ECE, MECH, CSE, CSBS, IT, CIVIL, MCA, MBA Department faculty members, through this faculty members can able to understand the industry 4.0. We request you to provide permission to conduct the same.

Thank You

Yours Truly,

ATTESTED

Dr. S. RAMABALAN, M.E., Ph.D.,
PRINCIPAL
E.G.S. Pillay Engineering College,
Thethi, Nagore - 611 002.
Nagapattinam (Dt) Tamil Nadu.



Dr. S. MANIKANDAN
Associate Professor and Head
Chairman - Board of Studies
Department of Information Technology
E.G.S. Pillay Engineering College
Nagapattinam - 611 002.

E.G.S PILLAY ENGINEERING COLLEGE

Nagapattinam – 611 002.Tamil Nadu, India.

(An Autonomous Institution, Affiliated to Anna University, Chennai.)

DEPARTMENT OF INFORMATION TECHNOLOGY

FDP ON INDUSTRY 4.0

(DIGITIZATION AND OPPORTUNITIES FOR SUSTAINABILITY)

SCHEDULE

S.No.	DATE	SESSION I	SESSION II	L U N C H B R E A K	SESSION III	SESSION IV
1.	28.04.2021	Introduction to industry 4.0	Industry 4.0 modality: Need and challenges		Adoption of Industry 4.0 in various sectors	Industry 4.0 implementation across countries
2.	29.04.2021	Innovative teaching learning method using augmented reality technology-an industry 4.0 initiative.	Key trending technologies and their use cases for industry4.0-- AR/VR, 5G, blockchain, etc.		Conclusion and implications	future directions
3.	30.04.2021	Stress management, meditation and human values and ethics			Hands-on sessions	

ATTESTED

Dr. S. RAMABALAN, M.E., Ph.D.,
PRINCIPAL
E.G.S. Pillay Engineering College,
Thethi, Nagore - 611 002.
Nagapattinam (Dt) Tamil Nadu.

Coordinators

JAYA SAKTHI K
Senior IoT Architect

Mobile : +91- 8870448049
Email : shakthik92@gmail.com
www.shakthi.me

OBJECTIVE

Middle level assignments in IoT and software Application Development with an organisation of high repute

SKILL SET	PROFILE SNAPSHOT
Software Development	<ul style="list-style-type: none"> • A result-oriented professional with 5+ years of experience in Web designing and Application Development • Working an IoT for the past 3 year. • Presently associated with CannySoft, Chennai as Senior Web Developer • Drove efforts towards maintaining software development practices; adhered to company standards for coding and unit/functional test coverage • Abilities in studying state-of-the-art development tools, programming techniques & computing equipment and maintaining personal networks • Track record of providing solutions to client's requirements involving design and debugging jobs for cleansing & transforming data according to business rules • A keen communicator with honed interpersonal, problem solving and negotiation abilities
Internet of Things	
Web Designing	
Project Execution	
Requirement Gathering	
Coding	
Client Servicing	

TECHNICAL SKILLS

Coding Languages:	PHP , Python, WordPress, Drupal, chart.js, Handlebar.js,three.js
Web Technologies:	HTML, CSS , JavaScript, JQuery, AJAX, XML, JSON, Bootstrap
Databases:	MySQL
Miscellaneous:	Rational Rose, Tortoise SVN, PhotoShop, CPanal and WHM, Filezilla, MS Office

ACADEMIC DETAILS

- **B.E.** (Computer Science and Engineering) from Anna University – Chennai, in 2013; secured 6.58 CGPA (1st class)
- 12th from PACM.Hr.Sec.School, Rajapalayam, in 2009; secured 78%
- 10th from PACM.Hr.Sec.School, Rajapalayam, in 2007; secured 80.4%

EMPLOYMENT DETAILS

Company Name:	Membha Technologies , Chennai - www.membha.com
Working Period :	May 2016 - Present
Position:	IoT Architect

PRINCIPAL
E.G.S. Pillay Engineering College,
Thethi, Nagore - 611 002.
Nagapattinam (Dt) Tamil Nadu.

Project Name: Water Plant Monitoring

Duration: May 2018 to Present (6 Months)

Description: Monitoring TDS, Raw Water flow/volume, product water flow/volume. The outcome is, increasing the efficiency of the entire plant.

Technologies & Components Used: TDS, Flow, NodeMCU, ModeBUS Gateway, MQTT, Mango DB, PHP, JQuery

My Role: Project Manager

Project Name: TrackJoy

Duration: December 2017 to April 2018 (5 Months)

Description: It is a fleet management application for the perishable goods. It helps to keep track the health of the goods, as well as fleet's position and fuel level.

Technologies & Components Used: GPS/ GSM module, NodeMCU, Freeboard, MySQL, JQuery, JS, D3.JS, MQTT

My Role: Project Manager

Project Name: ColdMagic

Duration: May 2017 to November 2017 (6 Months)

Description: High level Plug and play Cold Storage Management Solution. Live updates with remote monitoring.

Technologies & Components Used: Raspberry Pi 0 W, Django, MySQL, JQuery, JS, Chart.JS, MQTT

My Role: Project Manager

Project Name: Pharma Digilock

Duration: January 2017 to April 2017 (4 Months)

Description: RFID based door control system in a pharma company where raw materials under go to the chemical reaction in a particular Pressure.

Technologies & Components Used: Arduino, RFID, PHP, MySQL, JQuery, JS, HTML, CSS

My Role: IoT Developer

ATTESTED

Dr. S. RAMABALAN, M.E., Ph.D.,
PRINCIPAL
E.G.S. Pillay Engineering College,
Thethi, Nagore - 611 002.
Nagapattinam (Dt) Tamil Nadu.

Project Name: 1 MW Solar Power Plant on Chennai Trade centre (Roof top)

Duration: August 2016 to December 2016 (4 Months)

Description: 137 KW solar power plant. I developed remote monitoring solution to control the device and collect the data.

Technologies & Components Used: NodeMCU, Raspberry Pi 3, MQTT, PHP, MySQL, JQuery, JS, HTML, CSS, D3.JS

My Role: Senior IoT Engineer

Project Name: Adhive NanoPV Solar Power plant

Duration: May 2016 to July 2016 (2 Months)

Description: 137 KW solar power plant. I developed remote monitoring solution to control the device and collect the data.

Technologies & Components Used: Arduino, Zigbee, PHP, MySQL, JQuery, JS, HTML, CSS, D3.JS

My Role: IoT Developer

Company Name :	CannySoft, Chennai
Working Period :	August 2015 – April 2016
Position :	Senior Web Developer

Project Name: MyCliniQ

Duration: January 2016 to May 2016 (6 Months)

Description: Clinic maintenance software. This gives variety of options to the clinic admins and doctors to manage their patients.

Technologies Used: PHP, MySQL, AJAX, JQuery, JS, HTML, CSS

My Role: Team Leader

Project Name: Sri Sankalpa

Duration: November 2015 to December 2015 (2 Months)

Description: Complete Temple Administrative software. This gives full control to manage Users, Accounts, Inventory, Products and donors to the Administrator

Technologies Used: PHP, MySQL, JQuery, JS, HTML, CSS

My Role: Team Leader

ATTESTED

**Dr. S. RAMABALAN, M.E., Ph.D.,
PRINCIPAL
E.G.S. Pillay Engineering College,
Thethi, Nagore - 611 002.
Nagapattinam (Dt) Tamil Nadu.**

Project Name: Trepcred

Duration: July 2015 to October 2015 (3 Months)

Description: Real time bidding website (Like Freelancer and Taskrabbit)

Technologies Used: Drupal, PHP, MySQL, JQuery

My Role: Team Leader

Company Name	CannySoft, Chennai
Working Period	August 2014 – August 2015
Position	Web Developer

Project Name: CannyIMS

Duration: March 2015 to July 2015 (4 Months)

Description: Campus Management System. This can be useful for both schools and universities. Complete tracking of Students Academic, attendance and others.

Technologies Used: PHP, MySQL, AJAX, JQuery, JS, HTML, CSS

My Role: Developer

Project Name: Dcentral

Duration: January 2015 to March 2015 (3 Months)

Description: Easy Customisable Form solution, which can be suitable for any kind of office environment.

Technologies Used: PHP, MySQL, JQuery, JS, HTML, CSS

My Role: Junior Developer

Project Name: Waitease

Duration: September 2014 to December 2014 (3 Months)

Description: Taxi booking site (Like Uber). This Simple user Interface site can give the new comfort way to book taxi.

Technologies Used: Python, HTML, CSS, JQuery, MySQL

My Role: Developer cum Designer

ATTESTED

Dr. S. RAMABALAN, M.E., Ph.D.,
PRINCIPAL
E.G.S. Pillay Engineering College,
Thethi. Nagore - 611 002.
Nagapattinam (Dt) Tamil Nadu.

Company Name :	CannySoft, Chennai
Working Period :	March 2013 – August 2014
Position :	Junior Web Developer / Designer

I've developed, maintained many corporate Intranet and internet Websites, applications, and Blogs.

PERSONAL DETAILS

Languages :	Tamil, English
Hobbies :	Quora , IoT, Buzzle solving
Date of Birth :	May 25th 1992
Address :	7, Saraswathy Nagar, Neelankarai, ECR, Chennai- 41. (Available for relocation)

I hereby declare that the above information is true to the best of my knowledge and belief.

ATTESTED



**Dr. S. RAMABALAN, M.E., Ph.D.,
PRINCIPAL**

**E.G.S. Pillay Engineering College,
Thethi, Nagore - 611 002
Nagapattinam (Dt) Tamil Nadu**

FDP on Industry 4.0 (Digitization & Opportunities for Sustainability)

(For E.E, ECE, MECH, CSE, CSBS, IT, CIVIL, MCA, MBA)

Venue: CC3 Lab

Date: 28/04/2021 to 30/04/2021

S.No	Name of the Faculty	Designation/Dept	Signature					
			28/04/2021		29/04/2021		30/04/2021	
			FN	AN	FN	AN	FN	AN
	S. Anand Kumar	Asp/IT	[Signature]	[Signature]	[Signature]	[Signature]	[Signature]	[Signature]
	V.M. SUBASH	AP/IT	[Signature]	[Signature]	[Signature]	[Signature]	[Signature]	[Signature]
	Dr. V. Sathiga	ECF/ASP	[Signature]	[Signature]	[Signature]	[Signature]	[Signature]	[Signature]
	Dr. T. Suresh Kumar	ECE/Prof	[Signature]	[Signature]	[Signature]	[Signature]	[Signature]	[Signature]
	A. Heera	AP/MCA	[Signature]	[Signature]	[Signature]	[Signature]	[Signature]	[Signature]
	R. Anand Babu	AP/IT	[Signature]	[Signature]	[Signature]	[Signature]	[Signature]	[Signature]
	S. Praveen Kumar	AP/CSE	[Signature]	[Signature]	[Signature]	[Signature]	[Signature]	[Signature]
	Devi S. K.	AP/CSBS	[Signature]	[Signature]	[Signature]	[Signature]	[Signature]	[Signature]
	K. Nagalakshmi	ASPI/IT	[Signature]	[Signature]	[Signature]	[Signature]	[Signature]	[Signature]
	A.M. Priya	P/CSE	[Signature]	[Signature]	[Signature]	[Signature]	[Signature]	[Signature]
	V. YOKESHWAR	AP/EEE	[Signature]	[Signature]	[Signature]	[Signature]	[Signature]	[Signature]
	R. Lavanya	AP/IT	[Signature]	[Signature]	[Signature]	[Signature]	[Signature]	[Signature]
	S. J. Mahalingam	AP/ECE	[Signature]	[Signature]	[Signature]	[Signature]	[Signature]	[Signature]
	S. Murgesh	AP/Mech	[Signature]	[Signature]	[Signature]	[Signature]	[Signature]	[Signature]
	Dr. V. Sivarama	Prof/Mech	[Signature]	[Signature]	[Signature]	[Signature]	[Signature]	[Signature]
	P. Venkatesh	AP/CSE	[Signature]	[Signature]	[Signature]	[Signature]	[Signature]	[Signature]
	P. J. Suresh Babu	AP/CSE	[Signature]	[Signature]	[Signature]	[Signature]	[Signature]	[Signature]
	S. Sathi Kanakalakshmi	AP/IT	[Signature]	[Signature]	[Signature]	[Signature]	[Signature]	[Signature]
	Mrs. C. Mallika	ASG PWT/MCA	[Signature]	[Signature]	[Signature]	[Signature]	[Signature]	[Signature]
	K. RAJU	AP/IT	[Signature]	[Signature]	[Signature]	[Signature]	[Signature]	[Signature]
	M. Meenu	AP/ECE	[Signature]	[Signature]	[Signature]	[Signature]	[Signature]	[Signature]
	S. Santhikumar	AP/ECE	[Signature]	[Signature]	[Signature]	[Signature]	[Signature]	[Signature]
	P. Poornima	AP/IT	[Signature]	[Signature]	[Signature]	[Signature]	[Signature]	[Signature]

ATTESTED



Dr. S. RAMABALAN, M.E., Ph.D.,
 PRINCIPAL
 E.G.S. Pillay Engineering College,
 Thethi, Nagore - 611 002.
 Nagapattinam (Dt) Tamil Nadu.

FDP on Industry 4.0 (Digitization & Opportunities for Sustainability)

(For I.T., E.C.E., M.E.C.H., CSE, CSBS, IT, CIVIL, MCA, MBA)

Date: 28/04/2021 to 30/04/2021

Venue: C.T. Lab

S.No	Name of the Faculty	Designation/Dept	Signature					
			28/04/2021		29/04/2021		30/04/2021	
			IN	AS	IN	AS	IN	AS
1	A. Baskar	AP/CSE						
2	G. Anand Selvaraj	AP/CSE						
3	Manikanda Kurumagan	AP/IT						
4	K. Parthasarathi	AP/IEE						
5	N. Murali	AP/CSE						
6	Subasri P.	AP/CSE						
7	Anakathas	prof/IT						
8	Rajesh. I.	AP/CSE						
9	Ramachandran	AP/ECE						
10	Mungara	AP/CSBS						
11	Uthra	AP/ECE						
12	T. Senthil Kumar	AP/ECE						
13	Rakiraman	AP/CSBS						
14	K. Srinivas	AP/ECE						
15	R. Sivakala	AP/IT						
16	Selvaganesan	AP/MCA						
17	Vanitha. J	AP/MCA						

HOB II

1.
 2.
 Course Coordinator

ATTESTED

Dr. S. RAMABALAN, M.E., Ph.D.,
PRINCIPAL
 E.G.S. Pillay Engineering College,
 Thethi, Nagore - 611 002.
 Nagapattinam (Dt) Tamil Nadu.



E.G.S PILLAY ENGINEERING COLLEGE

(Autonomous)

NAGAPATTINAM.

Affiliated to Anna University, Chennai

Approved by AICTE, NEW – DELHI

FACULTY DEVELOPMENT PROGRAMME

ON

INDUSTRY 4.0-DIGITALIZATION AND SUSTAINABILITY

This is to certify that Sathiya V has attended the Three-day faculty development programme on “*Industry 4.0-Digitalization and Sustainability*” Organized by the Department of Information Technology from 28/04/2021 to 30/04/2021

Dr. S. Manikandan

HoD of IT
E.G.S Pillay Engineering
College

Dr. S. Ramabalan

Principal
E.G.S Pillay Engineering
College

ATTESTED

**Dr. S. RAMABALAN, M.E., Ph.D.,
PRINCIPAL**

E.G.S. Pillay Engineering College,
Thethi, Nagore - 611 002.
Nagapattinam (Dt) Tamil Nadu.



E.G.S PILLAY ENGINEERING COLLEGE

(Autonomous)

NAGAPATTINAM.

Affiliated to Anna University, Chennai

Approved by AICTE, NEW – DELHI

FACULTY DEVELOPMENT PROGRAMME

ON

INDUSTRY 4.0-DIGITALIZATION AND SUSTAINABILITY

This is to certify that Anand Babu R has attended the Three-day faculty development programme on “*Industry 4.0-Digitalization and Sustainability*” Organized by the Department of Information Technology from 28/04/2021 to 30/04/2021

Dr. S. Manikandan
HoD of IT
E.G.S Pillay Engineering
College

Dr. S. Ramabalan
Principal
E.G.S Pillay Engineering
College

ATTESTED

Dr. S. RAMABALAN, M.E., Ph.D.,
PRINCIPAL

E.G.S. Pillay Engineering College,
Thethi, Nagore - 611 002.
Nagapattinam (Dt) Tamil Nadu.



E.G.S PILLAY ENGINEERING COLLEGE

(Autonomous)

NAGAPATTINAM.

Affiliated to Anna University, Chennai

Approved by AICTE, NEW - DELHI

FACULTY DEVELOPMENT PROGRAMME

ON

INDUSTRY 4.0-DIGITALIZATION AND SUSTAINABILITY

This is to certify that Sivaramakrishnan V has attended the Three-day faculty development programme on "**Industry 4.0-Digitalization and Sustainability**" Organized by the Department of Information Technology from 28/04/2021 to 30/04/2021

Dr. S. Manikandan
HoD of IT
E.G.S Pillay Engineering
College

Dr. S. Ramabalan
Principal
E.G.S Pillay Engineering
College

ATTESTED

Dr. S. RAMABALAN, M.E., Ph.D.,
PRINCIPAL
E.G.S. Pillay Engineering College,
Thethi, Nagore - 611 002.
Nagapattinam (Dt) Tamil Nadu.



E.G.S PILLAY ENGINEERING COLLEGE

(Autonomous)

NAGAPATTINAM.

Affiliated to Anna University, Chennai

Approved by AICTE, NEW - DELHI

FACULTY DEVELOPMENT PROGRAMME

ON

INDUSTRY 4.0-DIGITALIZATION AND SUSTAINABILITY

This is to certify that Sakthi Kamalanathan S
has attended the Three-day faculty development
programme on “*Industry 4.0-Digitalization and
Sustainability*” Organized by the Department of
Information Technology from 28/04/2021 to
30/04/2021

Dr. S. Manikandan
HoD of IT
E.G.S Pillay Engineering
College

Dr. S. Ramabalan
Principal
E.G.S Pillay Engineering
College

ATTESTED

Dr. S. RAMABALAN, M.E., Ph.D.,
PRINCIPAL
E.G.S. Pillay Engineering College,
Thetti, Nagore - 611 002
Nagapattinam (Dt) Tamil Nadu



E.G.S PILLAY ENGINEERING COLLEGE

(Autonomous)

NAGAPATTINAM.

Affiliated to Anna University, Chennai

Approved by AICTE, NEW - DELHI

FACULTY DEVELOPMENT PROGRAMME

ON

INDUSTRY 4.0-DIGITALIZATION AND SUSTAINABILITY

This is to certify that Ramachandran R has attended the Three-day faculty development programme on "**Industry 4.0-Digitalization and Sustainability**" Organized by the Department of Information Technology from 28/04/2021 to 30/04/2021

ATTESTED

Dr. S. RAMABALAN, M.E., Ph.D.,
PRINCIPAL

E.G.S. Pillay Engineering College,
Thethi, Nagore - 611 002.
Nagapattinam (Dt) Tamil Nadu.

Dr. S. Manikandan
HoD of IT
E.G.S Pillay Engineering
College

Dr. S. Ramabalan
Principal
E.G.S Pillay Engineering
College

E.G.S Pillay Engineering College
(Autonomous), Nagapattinam
Department of Information Technology

Feedback of FDP

Name of Faculty/Staff: Dr./Ms./Mr. Sakthi Kamalanathan . S
 Department: MBA Designation: Ap
 Title of FDP: Industry 4.0 - Digitalization and sustainability
 Mode of FDP: online /offline / web casting
 Dates of FDP: From 28 / 04 / 2021 To 30 / 04 / 2021

Please respond below with 1, 2, 3, 4 or 5, where 1 and 5 are explained.

		YES / NO
(1)	Were objectives of the FDP clear to you?	<input checked="" type="checkbox"/> / <input type="checkbox"/>
(2)	The Programme contents met with your expectations <i>1. Strongly disagree 5. Strongly agree</i>	5
(3)	The lecture sequence was well planned <i>1. Strongly disagree 5. Strongly agree</i>	4
(4)	The level of the FDP was <i>1. Too low 5. Too high</i>	5
(5)	The FDP contents compared with your expectations <i>1. Too theoretical 5. Too empirical</i>	4
(6)	The FDP exposed you to new knowledge and practices <i>1. Strongly disagree 5. Strongly agree</i>	4
(7)	Will you expect FDP from our department? <i>1. Not at all 5. Very strongly</i>	5
(8)	The lectures were clear and easy to understand <i>1. Strongly disagree 5. Strongly agree</i>	4
(9)	The teaching aids were effectively used <i>1. Strongly disagree 5. Strongly agree</i>	5

ATTESTED

Dr. S. RAMABALAN, M.E., Ph.D.
PRINCIPAL
 E.G.S. Pillay Engineering College,
 Thethi, Nagore - 611 002.
 Nagapattinam (Dt) Tamil Nadu.

(10)	The FDP material handed out was adequate <i>1. Strongly disagree 5. Strongly agree</i>
(11)	The Resource Person encouraged interaction and were helpful <i>1. Strongly disagree 5. Strongly agree</i>
(12)	Were objectives of the FDP realized?

5

4

YES / NO
 /

Any other Feedback

Organized well and useful for me

Signature

ATTESTED

Dr. S. RAMABALAN, M.E., Ph.D.,
PRINCIPAL
 E.G.S. Pillay Engineering College,
 Thethi, Nagore - 611 002,
 Nagapattinam (Dt) Tamil Nadu.

E.G.S Pillay Engineering College
(Autonomous), Nagapattinam
Department of Information Technology

Feedback of FDP

Name of Faculty/Staff: Dr./Ms./Mr. Venugula - P

Department: CSE Designation: AP

Title of FDP: Industry 4.0 - Digitalization and Sustainability

Mode of FDP: online /offline / web casting

Dates of FDP: From 28 / 04 / 2021 To 30 / 04 / 2021

Please respond below with 1, 2, 3, 4 or 5, where 1 and 5 are explained.

		YES / NO
(1)	Were objectives of the FDP clear to you?	<input checked="" type="checkbox"/> / <input type="checkbox"/>
(2)	The Programme contents met with your expectations <i>1. Strongly disagree 5. Strongly agree</i>	5
(3)	The lecture sequence was well planned <i>1. Strongly disagree 5. Strongly agree</i>	4
(4)	The level of the FDP was <i>1. Too low 5. Too high</i>	4
(5)	The FDP contents compared with your expectations <i>1. Too theoretical 5. Too empirical</i>	5
(6)	The FDP exposed you to new knowledge and practices <i>1. Strongly disagree 5. Strongly agree</i>	4
(7)	Will you expect FDP from our department? <i>1. Not at all 5. Very strongly</i>	5
(8)	The lectures were clear and easy to understand <i>1. Strongly disagree 5. Strongly agree</i>	3
(9)	The teaching aids were effectively used <i>1. Strongly disagree 5. Strongly agree</i>	4

ATTESTED

Dr. S. RAMABALAN, M.E., Ph.D.
PRINCIPAL

E.G.S. Pillay Engineering College,
Thethi, Nagore - 611 002.
Nagapattinam (Dt) Tamil Nadu.

(10)	The FDP material handed out was adequate <i>1. Strongly disagree 5. Strongly agree</i>
(11)	The Resource Person encouraged interaction and were helpful <i>1. Strongly disagree 5. Strongly agree</i>
(12)	Were objectives of the FDP realized?

4

4

YES / NO
 /

Any other Feedback

Organized nice.

Signature

PM

ATTESTED

Dr. S. RAMABALAN, M.E., Ph.D.,
PRINCIPAL
 E.G.S. Pillay Engineering College,
 Thethi Nagore - 611 002,
 Nagapattinam (Dt) Tamil Nadu.

E.G.S PILLAY ENGINEERING COLLEGE

Nagapattinam – 611 002.Tamil Nadu, India.

(An Autonomous Institution, Affiliated to Anna University, Chennai.)

DEPARTMENT OF INFORMATION TECHNOLOGY

FDP ON INDUSTRY 4.0

(DIGITIZATION AND OPPORTUNITIES FOR SUSTAINABILITY)

REPORT

Three-day Faculty Development programme on “Industry 4.0” was successfully conducted on 28/04/2021 to 30/04/2021 organized by the department of Information technology, E.G.S.Pillay Engineering college, Nagapattinam. Total number of 40 participants were attended the FDP.

Dr.S. Manikandan, Associate professor department of Information technology addressed the participants and gave brief introduction about the FDP. Then Mrs. K. Nagalakshmi Associate professor welcomes and emphasized on the importance and flow of the FDP.

Mr.Jayasakthi senior IoT architect handled the sessions with recent trends Industry 4.0 digitalization and opportunities for sustainability, The sessions were very informative and interactive. Feedback was collected from all the participants and certificates are distributed to all active participants.

Finally Mrs.R.Lavanya Assistant professor, department of information technology given vote of thanks.



Dr. S. MANIKANDAN
Associate Professor and Head
Chairman - Board of Studies
Department of Information Technology
E.G.S. Pillay Engineering College
Nagapattinam - 611 002.

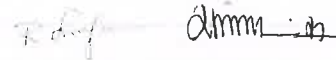

Coordinator

ATTESTED

Dr. S. RAMABALAN, M.E., Ph.D.,
PRINCIPAL
E.G.S. Pillay Engineering College,
Thethi, Nagore - 611 002.
Nagapattinam (Dt) Tamil Nadu.

E.G.S. PILLAY ENGINEERING COLLEGE, NAGAPATTINAM

(An Autonomous Institution)

Affiliated to Anna University, Chennai | Approved by AICTE, New Delhi
Accredited by NAAC with "A" Grade | An ISO 9001:2015 Certified Institution

25
YEARS OF
EXCELLENCE

***Faculty Development Programme on "Introduction to
Securities market"***

by Dr. P. Karthika & Dr. K. Prabhakaran

A SEBI Sponsored Program

Organized by Department of Management Studies

Date: Monday, January 25, 2021

Time: 02.00 pm to 04.30 pm

Cisco Webex

Meeting Web-

<https://sebibcp.webex.com/sebibcp/j.php?MTID=md5133c1b308849f3f4de2e9e61c72608>

Meeting number: 176 684 1111

Password: 1234

ATTESTED

**Dr. S. RAMABALAN, M.E., Ph.D.,
PRINCIPAL**

**E.G.S. Pillay Engineering College,
Thethi, Nagore - 611 002.
Nagapattinam (Dt) Tamil Nadu.**

E.G.S. PILLAY ENGINEERING COLLEGE, NAGAPATTINAM

(An Autonomous Institution)

Affiliated to Anna University, Chennai | Approved by AICTE, New Delhi
Accredited by NAAC with "A" Grade | An ISO 9001:2015 Certified Institution

25
YEARS OF
EXCELLENCE

***Faculty Development Programme on "Introduction to
Securities market"***

by Dr. P. Karthika & Dr. K. Prabhakaran

A SEBI Sponsored Program

CONVENED BY : DR. R. KARTHI, Director, Department of Management Studies

BENEFICIARIES : FACULTY MEMBERS

GUEST SPEAKER : Dr. P. KARTHIKA & DR. K. PRABHAKARAN

CONDUCTED ON : January 25, 2021 between 02.00 PM & 04.30PM

30/01/2021
Convenor

**Dr. R. Karthi,
Director/MBA**

ATTESTED

**Dr. S. RAMABALAN, M.E., Ph.D.,
PRINCIPAL**

**E.G.S. Pillay Engineering College,
Thethi, Nagore - 611 002.
Nagapattinam (Dt) Tamil Nadu.**

Contents

S. No	Description
1	Participants Name List
2	Profile of Guest Speaker
3	Event Invitation
4	Welcome Note
5	Synopsis of the Event & Event Photos
6	Feedback Form
7	Feedback Procured from Students
8	Feedback Analysis

ATTESTED



**Dr. S. RAMABALAN, M.E., Ph.D.,
PRINCIPAL**

E.G.S. Pillay Engineering College,
Thethi, Nagore - 611 002.
Nagapattinam (Dt) Tamil Nadu,

Participants List

ATTESTED



Dr. S. RAMABALAN, M.E., Ph.D.,
PRINCIPAL

E.G.S. Pillay Engineering College,
Thethi, Nagore - 611 002.
Nagapattinam (Dt) Tamil Nadu

Participants List:

NAME	DESIGNATION	DEPARTMENT	INSTITUTION
Jamuna	Ap	Maths	Admc
VELLINGIRI P	Associate Professor	Commerce	VET Institute of Arts and Science
Dr R Velmurugan	Associate Professor	Commerce	Karpagam Academy of Higher Education, Coimbatore
SakthiKamalNathan	Assistant Professor	MBA	EGS PILLAY ENGINEERING COLLEGE
Sathish kumar	Assistant professor	MBA	E. G.S.Pillay Engineering college
Sayee Sudha	Assistant professor	MBA	EGS Pillay engineering college
Dr. G. Sridevi	Professor	MBA	A. V. C. College of Engineering
BALAIKSHWARYA P	Assistant professor	MBA	E.G.S.Pillay Engincering college, Nagapattinam
A. Sowarna lakshmi	Assistant professor	MBA	E.G.S Pillay Engineering college.
Dr.V.RENUGA	Associate Professor	Commerce	A.DM.COLLEGE FOR WOMEN (AUTONOMOUS), NAGAPATTINAM
Dr.R.Manimozhi	Assistant Professor	English	A.D.M.College for Women(Autonomous) Nagapattinam
Dr. B. KARTHIKEYAN	Associate Professor	Business Administration	Annamalai University
Dr. V.Thamodaran	Associate Professor	Business Administration	Annamalai university
Dr.K.GUNASEKARAN	Assistant Professor	Dept.of.Business Administration	Annamalai University
Mohamed Naina Maricar	Placement officer	T&P	Egsp
V.Ravichandran	Assistant professor	Business Administration	Government Arts college, Kulithalai
KARTHIKEYAN M	Research Scholar	Commerce	Sri Paramakalyani College Alwarkurichi
Dr.J.SUNDARARAJ	Associate Professor	Commerce	Annamalai University
M.pallavi	Associate professor	Business management	Sardar Patel college
Dr.Sivakumar P	Assistant Professor	Department of Management Studies	University of Madras
Dr. J.Tamilselvi	Associate Professor	Department of Business Administration	Annamalai University
B. Asha Daisy	Asst.Prof	MBA	E.G.S.Pillay Engineering College

Dr. S. RAMABALAN, M.E., Ph.D.,
PRINCIPAL

E.G.S. Pillay Engineering College,
Thethi, Nagore - 611 002.
Nagapattinam (Dt) Tamil Nadu.

Stalin	Assistant professor	Master of business administration	EGS Pillai Engineering college
Dr.S.Fabiyola Kavitha	Associate Professor	Department of Management Studies	SRM Trichy Arts and science college
VINOTH BALAJI V	ASSISTANT PROFESSOR	MANAGEMENT STUDIES	SRM TRICHY ARTS AND SCIENCE COLLEGE
Balasaraswathi.G	Assistant professor	MBA	E.G.S.pillai engineering college
Monika Dasharath Gorkhe	Assistant Professor	MBA	Dr D Y Patil Institute of Management Studies (DYPIMS)
Sourav Khan	Meom	Commerce	University of calcutta
Dr.Shruthi S	Assistant Professor	Commerce	PES College of Science Arts and Commerce
SUJATHA S.L	Assistant professor	MBA	Bangalore Institute of Technology
Subhash Chandra Sharma	Regional PF Commissioner	HR	EPFO
Dr Renuka Deshmukh	Assistant Professor	School of Management (PG)	MIT World Peace University
Prof Supriya Balasaheb Zargad	Assistant professor	Management	Mahatma Phule institute of management and computer studies Hadapsar
Infanta.x	Assistant professor	Professional accounting	Nirmala College for Women
Dr MINI MATHEW K C	ASSISTANT PROFESSOR	COMMERCE	LOYOLA COLLEGE (AUTONOMOUS) CHENNAI
Heena	Research Scholar	University school of applied management	Punjabi university Patiala
Netravathi P	Lecturer	Department of studies in Economics and cooperation	University of Mysore
Ramireddy Devarapalli	P.G student (LLM)	Legal	Mahatma Gandhi Law College, Osmania University, Hyderabad.
Dr.G.Parimalarani	Professor	Banking Management	Alagappa University
Mr Sidharth Rajendra Patil	Assistant Professor	Management	Abasaheb Garware Institute of Management Studies Sangli
DR. NISHIT DAVE	HOD	Accountancy Dept.	Ladhidevi Ramdhar Maheshwari College
Charu Sharma	Junior Research Fellow	Accountancy and Business Statistics	Mohanlal Sukhadia University, udaipur
SNEHA PRASAD	PG STUDENT	ELECTRONICS AND COMMUNICATION ENGINEERING	SIR M VISVESVARAYA INSTITUTE OF TECHNOLOGY
Dr. Pallavi Kiran Ingale	Assistant Professor	Center for Management Education	Vaikunth Mehta National Institute of Cooperative Management
ANITHA KUMARI.B	ASSISTANT PROFESSOR	MANAGEMENT STUDIES	Dr. S. RAMABALAN, M.E., Ph.D., REVA UNIVERSITY

E.G.S. Pillay Engineering College,
Thethi, Nagore - 611 002.
Nagapattinam (Dt) Tamil Nadu.

Jayalakshmi N A	Assistant professor	Management	REVA University
Ramesh Chandrasaha	Assistant Professor	MBA	Institute of Management Studies, Davanagere University
Pooja P R	Scholar	Management	Institute of management studies Davanagere University
Dr. Bipin Chandra Pant	Associate professor	Hotel management	K.L.University
SUBODH G KRISHNA	Assistant Professor	Management	Mount Zion Institute of Management, Chengannur
Dr.S.SINGARAVADIVEL	Assistant Professor	Commerce	Swami Dayananda College of Arts and Science, Manjakkudi
G.PRAVEENRAJ	Student	M.B.A (HRM)	B.D.U.C.college nagapatinam
SHAIK ABDUL RAFI	RESEARCH SCHOLAR	BUSINESS MANAGEMENT	YOGI VEMANA UNIVERSITY, KADAPA
Dr.M.S.GAYATHRI	Assistant professor	MBA	A.V.C.college of Engineering
Dr.K.Keerthi	Assistant professor	Management studies	A.V.C College of Engineering
RENUKADEVI R	Assistant Professor	Management Studies	A.V.C.College of Engineering
Jayashree N	Assistant Professor	Department of Management Studies	New Horizon College of Engineering
Dr.S.SaiGanesh	Deputy Director	Management Studies	Dayananda Sagar Business School
Dr.Priyank mishra	Associate professor	Commerce	Dr.C.V.R.U
Ashwini T K	Assistant professor	MBA	RNS Institute of Technology
Dr.S.GAYATHRI	Principal	Business Administration	Bon Secours Arts and Science College for Women, Dindigul.
Dr.Swathi.S	Assistant professor	Management science	Yuvaraja college
Sridevi C	Assistant Professor	Computer Science Department	Bon Secours Arts and Science College, Dindigul
Dr.M.Guhapriya	Assistant professor	Computer science	Bon secours arts and science college for women, Dindigul.
A P Sri Charan	Student	Commerce	Jamal Mohamed college
Dr.S PADMA ANNAKAMU	Assistant professor	Economics	PSGR Krishnammal college
P sreenivasa gopal	Founder & Director	Engineering	Beegee consults
Ms. Neeta M	Assistant Professor	Management	St. Claret College, Bangalore
RASHEEDHA BEGUM S	Assistant professor	COMMERCE	BON SECOURS ARTS AND SCIENCE COLLEGE DINDIGUL
Jimlinda.P	Assistant Professor	Commerce	Bon Secours Arts and Science College for Women, Dindigul

**Dr. S. RAMABALAN, M.E., Ph.D.,
PRINCIPAL**

E.G.S. Pillay Engineering College,
Thethi, Nagore - 611 002,
Nagapattinam (Dt) Tamil Nadu.

Profile of Guest Speaker

ATTESTED



Dr. S. RAMABALAN, M.E., Ph.D.,
PRINCIPAL

E.G.S. Pillay Engineering College,
Thethi, Nagore - 611 002.
Nagapattinam (Dt) Tamil Nadu.

Dr.P.KARTHIKA, B.Sc, MBA, Ph.D., NET.,
Assistant Professor-Finance
Department of MBA,
Vidyavardhaka College of Engineering,
Mysuru-Karnataka 570002
India



Google Scholar: <https://scholar.google.com/citations?user=kisrKLEAAAAAJ&hl=en&authuser=1>

Email: karthi.nathan21@gmail.com.

Mobile: 9095021200

Career Summary: Experience 10 Years teaching+ 1 Year Industry

- An innovative and knowledgeable professional having **10 years'** experience as a Teaching Faculty under Technical University affiliated college.
- Proficient in **Financial Derivatives, Financial Market and Institutions, Banking and Financial Services, Security Analysis and Insurance-Risk Management, Business Analytics and Research Methodology.**
- **National Stock Exchange (NSE)** certified Market professional for conducting Training courses.
- **SEBI RP and NCEF Trainer** acted as a resource person for more than 30 workshops in various colleges.
- Published **20 papers** in national and international level journals
- Presented more than 25 papers in various national/international level conference/seminars
- **CII empaneled Examiner for Banking and Financial Services and Financial Derivatives.**
- Recognized **Research Guide** under Visvesvaraya Technological University
- **Evaluated 4 Ph.Dtheses and guided more than 70 projects for MBA students**
- Organized seminars and workshop in the key area of Finance.
- Coordinator for NBA and NAAC Accreditation
- Coordinator for the Digital Learning.
- Board of Examiner in Visvesvaraya Technology University and PES college

Educational Background:

1. Ph.D.– Management (Finance-Financial Market)

Title: A study on impact of future trading and Macroeconomic variables on stock price volatility of S&P CNX Nifty Index.

University- Anna University, Chennai. (Among the top 15 Universities in India as per the NIRF ranking 2020)

Year of passing: 2016

ATTESTED

Dr. S. RAMABALAN, M.E., Ph.D.,
PRINCIPAL

E.G.S. Pillay Engineering College,
Thethi, Nagore - 611 002.

Nagapattinam (Dt) Tamil Nadu.

Achievements:

- **Patent Filed** on “Sustainable Leak proof Lunch Box made of by Aloe Vera Fiber” on August 2020
- **Patent Granted** on “Green Human Resource Management Practices Framework for Healthcare Organizations Under Stressful Covid-19” on 15th July 2020 by the Commissioner of IP Australia (Australian Government) Patent number: 2020101189
- **Patent publication** on “Data Integration Platform of unified payment interface for seasonal entrepreneurs” in the year 2020
- **Developed Excel Template model** for measuring course outcome and program outcome (Outcome Based Education) for present organization.
- **Conducted more than 30 Financial Education workshop** for various college student and self-help groups
- **Inventory Management project** was done for Anupam Textile, Tirupur
- **Technical Analysis of Index Future** with special reference to the National Stock Exchange project is completed at Angel Broking Ltd, Tirupur.
- **Top Academic performer** in Postgraduate

ATTESTED



**Dr. S. RAMABALAN, M.E., Ph.D.,
PRINCIPAL**

**E.G.S. Pillay Engineering College,
Thathi, Nagore - 611 002,
Nagapattinam (Dt) Tamil Nadu.**

Dr. K. Prabhakaran

Faculty –Finance & Accounting

E-Mail Id : praba_mba2003@yahoo.co.in

Mobile No: +91 9965466999



Summary

Qualifications	MBA,M.Phil., PGDMM,Ph.D.
Experience in Abroad	3 Years (Teaching & Research)
Experience in India	12 Years (Teaching, Industry& Research)
Subject Expertise	Security Analysis and Portfolio Management, Financial Derivatives, Financial Management, Financial Analysis, Financial Reporting Analysis, Wealth Management, Financial Accounting and Management Accounting
Certification	NSE Certified Market Professional (NCMP) SEBI Financial Education Resource Person
Visiting Faculty	MCUBE Academy (P) Ltd, Chennai, EDII TamilNadu and Premier Institutes in TamilNadu
Resource Person of Various Programmes	SEBI Financial Education Workshops-240, EDII Programmes -9, Guest Lectures-80, FDP -5 and BSE GFMA Star plus Program- 360 Hours
Publications	ABDC/Scopus Journals -2 International & National Journals- 27
Papers Presented	International & National Level Conferences - 40
Ph.D Thesis Evaluation	16 Theses (As a Foreign & Indian Examiner)
Projects Guided	MBA: 150 (Anna University, Chennai) & BA Honours:10 (Stirling University, UK)

Educational Qualification

Degree	University/Board	Area	Year
Ph.D	Bharathiyar University, Coimbatore, India	Finance	2014
M.Phil	Bharathiyar University, Coimbatore, India	Management	2008
MBA	School of Management, AnnamalaiUniversity, India	Finance	2005
B.Com	Sri Vasavi College, Erode, India	Commerce	2003

Experience Summary

Abroad Exposure

Designation	Institution	ATTESTED Period		Experience
		From	To	
		From	To	

Dr. S. KAMABALAN, M.E., Ph.D.,
PRINCIPAL

E.G.S. Pillay Engineering College,
Thethi, Nagore - 611 002.
Nagapattinam (Dt) Tamil Nadu.

Assistant Professor	Muscat College, Sultanate of Oman. (Affiliated with the University of Stirling, UK & Universiti of Malaysia Pahang, Malaysia)	February 2015	December 2017	3 Years
---------------------	--	---------------	---------------	---------

India Exposure

Designation	Institutions	Period		Experience
		From	To	
Visiting Faculty	Kalaignar Karunanidhi Institute of Technology (Autonomous) Coimbatore, MCUBE Academy (P) Ltd, Chennai, EDII, TamilNadu and Premier Institutes in TamilNadu	January 2018	Till Date	2 year
Assistant Professor(SRG)	RVS Faculty of Management, Coimbatore, India.	July 2010	Jan 2015	4 Year & 7 Months
Assistant Professor	Maharaja Prithvi Engineering College, Coimbatore, India.	Dec 2008	June 2010	1 Year & 7 Months
Investor Relations Officer	Karvy Stock Broking Ltd, Gobichettipalayam, India.	July 2005	Nov 2008	3 Years & 5 Months

Description

- ❖ Outcome based touched by International Universities.
- ❖ Chair of Departmental Development, Research and Entrepreneurship Development.
- ❖ Handled theory and problem papers (Especially Finance and Accounting papers).
- ❖ Coordinator of Placement and Training Cell and Alumni Association, etc.
- ❖ Trainer for NISM/NCFM certificate exams.
- ❖ Organized National and International level Seminars/Conferences, Guest lectures, Corporate Interactions, FDP'S&PDP'S.
- ❖ Question paper setter and evaluation of Ph. D thesis for various Universities.

Competencies

Security Analysis and Portfolio Management, Financial Derivatives, Financial Management, International Financial Management, Wealth Management, Financial Accounting, Management Accounting and Financial Reporting Analysis.

Research Interest

- ❖ Stock Market Volatility
- ❖ Financial Econometrics (Time Series Analysis)
- ❖ Technical Analysis

ATTESTED



Dr. S. RAMABALAN, M.E., Ph.D.,
PRINCIPAL

E.G.S. Pillay Engineering College,
Thethi, Nagore - 611 002,
Nagapattinam (Dt) Tamil Nadu.

- ❖ Capital Market Efficiency & Portfolio Construction
- ❖ FOREX Market

Research Projects

- ❖ Forecasting Stock Price Volatility - A Study with Reference to CNX NIFTY Companies in India. (During Ph.D.).
- ❖ A Study on the Financial Performance of Seshasayee Paper and Boards Ltd., Erode. (During MBA).

M, NCFM & BCFM Certificate Exams in India

1. NSE Certified Market Professional (NCMP)
2. Security Operation and Risk Management
3. Equity Derivative Modules
4. Depository Operations Certification Examination
5. Capital Market (Dealers) Module
6. Derivatives Market (Dealers) Module
7. Equity Derivative Certification Examination
8. Commodities Market Module
9. BSE Certification on Securities Markets

Awards

- ❖ Best Faculty award received by National Foundation for Entrepreneurship and Development (NFED) Chennai, India.
- ❖ Best NCC Under Officer Award received by National Integration Camp held at Karnal (Haryana State) and Sri Vasavi College, Erode, India.
- ❖ Best NSS volunteer Award received by Annamalai University, India.

Associate Editor/ Editorial Board Member

- ❖ Editorial board member of Amity Journal of Finance (AJF)-An International, Biannual, Refereed Journal of Finance.
- ❖ Associate Editor of Journal of Management and Science (ISSN No.2249-1260/Online ISSN: 2250-1819).
- ❖ Editorial cum Advisory board member of International Journal of Advanced Research In Commerce, Management & Social Science(IJARCMSS).
- ❖ Editorial cum Advisory board member of International Journal of Education, Modern Management, Applied Science & Social Science (IJEMASS).
- ❖ Editorial board member of Nehru School of Management Journal(NSMJ) – (ISSN: 2349-4883).
- ❖ Associate Editor of Indo Asian Journal of Management and Entrepreneurship (ISSN: 2319-2992).
- ❖ Editorial board member of Asia Pacific International Journal of Engineering Science (ISSN: 2455-3883).
- ❖ Editorial board member of International Journal of Advanced Research in Commerce and Management (ISSN: 2395-2539).

M/NSE Certification Courses Conducted

1. Kalaignar Karunanidhi Institute of Technology, Coimbatore
2. KGISL College of Arts and Science Coimbatore
3. Kamadhenu Arts and Science College, Sathiyamangalam, Erode
4. AJK Institute of Management, Coimbatore
5. SNS College of Arts and Science, Coimbatore
6. Kongu Arts and Science College, Erode

ATTESTED
Dr. S. RAMABALAN, M.E., Ph.D.,
PRINCIPAL
 E.G.S. Pillay Engineering College,
 Thethi, Nagore - 611 002.
 Nagapattinam (Dt) Tamil Nadu,

er Activities

- ❖ Number of sessions Chaired in National/International level Conferences: 25
- ❖ Number of Guest lecture's given: 80
- ❖ SEBI Financial Education programs across India: 240
- ❖ Entrepreneurship Awareness/NEEDS/PMEGP/UYEGP Programmes: 15

Personal Information

Name : Dr. K. Prabhakaran
Age : 38 Years
Date of Birth : 12-05-1982
Sex : Male
Marital Status : Married with one son
Passport Data : Z3032106
International Driving License : 101128932 issued by Royal Oman Police, Sultanate of Oman
Number : (Valid till December 2026)

Declaration

I hereby declare that all the information furnished by me is true to the best of my knowledge.

Dr. K. Prabhakaran

ATTESTED

Dr. S. RAMABALAN, M.E., Ph.D.,
PRINCIPAL
E.G.S. Pillay Engineering College,
Thethi, Nagore - 611 002.
Nagapattinam (Dt) Tamil Nadu.

Event Invitation

ATTESTED



Dr. S. RAMABALAN, M.E., Ph.D.,
PRINCIPAL

E.G.S. Pillay Engineering College,
Thethi, Nagore - 611 002,
Nagapattinam (Dt) Tamil Nadu.

e-Invite:



E.G.S. PILLAY ENGINEERING COLLEGE, NAGAPATTINAM

(An Autonomous Institution)

Affiliated to Anna University, Chennai, Approved by AICTE, New Delhi,
Accredited by NAAC with "A" Grade, An ISO 9001:2015 Certified Institution



DEPARTMENT OF MANAGEMENT STUDIES

ORGANIZES

AN ONLINE FACULTY DEVELOPMENT PROGRAM

INTRODUCTION TO SECURITIES MARKET

On January 25, 2021 between 02.00PM & 04.00PM

Hosts of the day are,



Dr. K. Prabhakaran,

SEBI & NCFE Financial Education Resource Person,
Faculty – Finance & Entrepreneurship,
Visiting Faculty – Premier Institutes in TamilNadu

Dr. P. Karthika,

Assistant Professor,
School of Management Studies,
Kongu Engineering College, Erode.



Organized and Convened by

Dr. R. Karthi,

Director & Head,
Department of Management Studies, EGSPEC

ATTESTED

**Dr. S. RAMABALAN, M.E., Ph.D.,
PRINCIPAL**

E.G.S. Pillay Engineering College,
Thethi, Nagore - 611 002.
Nagapattinam (Dt) Tamil Nadu.

Welcome Note

ATTESTED



Dr. S. RAMABALAN, M.E., Ph.D.,
PRINCIPAL

E.G.S. Pillay Engineering College,
Thethi, Nagore - 611 002.
Nagapattinam (Dt) Tamil Nadu,

Welcome Note by Mr. S. Sakthi Kamal Nathan

Good morning everyone, On behalf of E.G.S.Pillay Engineering college, Department of Management studies, I am very much glad to organize the SEBI sponsored Faculty Development Programme on "Introduction to Securities market". Its my pleasure to welcome our beloved Secretary Chev. Shri.S.Paramesvaran sir for encouraging us to organise series of events like this. I welcome you sir. I welcome our respected Principal Dr.S.Ramabalan sir. I welcome you sir. I welcome the today's resource persons Dr. K. Prabhakaran, Faculty Finance, SEBI & NCFE Financial Education Resource Person, Trainer for NISM/NCFM certificate exams, worked in Muscat College, Sultanate of Oman and having more than 15 years of teaching experience. I welcome you sir, and the another resource person Dr.P.Karthika, Assistant Professor, School of Management Studies, Kongu Engineering College, Erode. She has published more than 20 research papers and having proficient in Financial Derivatives, Financial Market and Institutions, Banking and Financial Services, Security Analysis and Insurance-Risk Management, Business Analytics and Research Methodology. She is an National Stock Exchange (NSE) certified Market professional for conducting Training courses. Also she is the SEBI RP and NCEF Trainer acted as a resource person for more than 30 workshops in various colleges. I welcome you madam. I welcome all the faculty members of MBA department for this wonderful session. And the most important I welcome all the faculty members, Industry Persons and Research Scholars from various institutions as participants of this programme. Once again I welcome you all for this FDP on Introduction to Securities Market.

ATTESTED

Dr. S. RAMABALAN, M.E., Ph.D.,
PRINCIPAL
E.G.S. Pillay Engineering College,
Thathi, Nagere - 611 002.
Nagapattinam (Dt) Tamil Nadu.

Synopsis of the event

ATTESTED



Dr. S. RAMABALAN, M.E., Ph.D.,
PRINCIPAL

E.G.S. Pillay Engineering College,
Thelhi, Nagore - 611 002.
Nagapattinam (Dt) Tamil Nadu.

Synopsis of the event:

The program was convened by Dr. R. Karthi, Director and Head of the Department of Management Studies, E.G.S. Pillay Engineering College. The program was conducted online to cultivate the awareness on securities market among the faculty members.

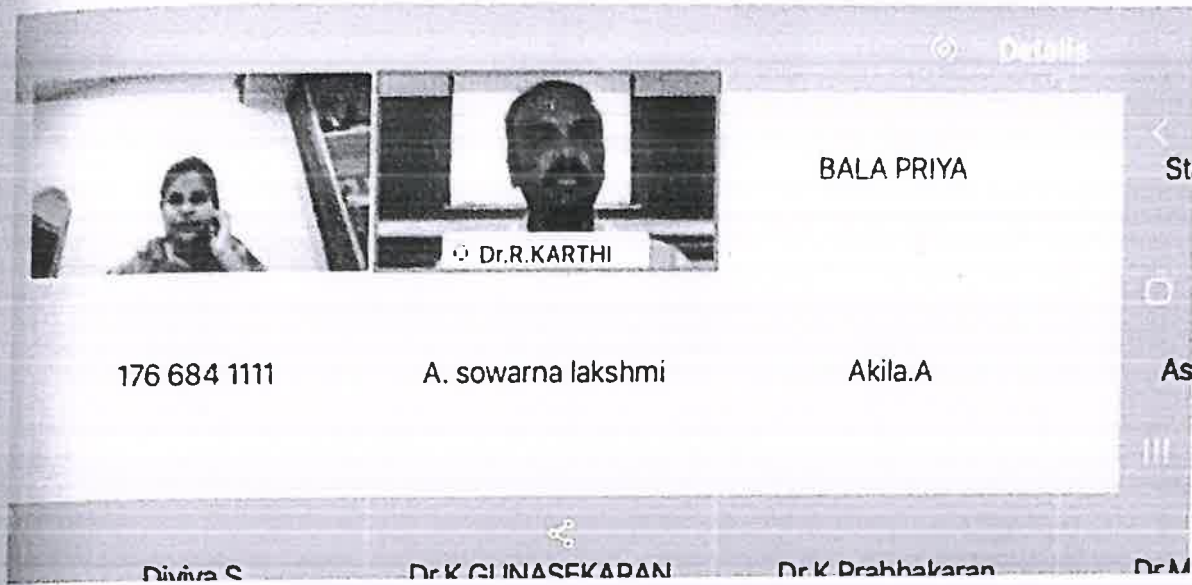

Zoom Meeting Controls: Call, Mute, Meeting Info, Hide Menu Bar, File, Edit, Share, View, Audio & Video, Participant, Meeting Help

Participants (35)

- Dr.R.KARTHI
- Dr.Karthika P
- Dr.K.Drahhakaran
- Dr.v.renuga
- 176 684 1111
- Dr.R.KARTHI
- Dr.Karthika P
- 176 684 1111
- A. A. sowarna lakshmi
- A. Akila.A
- Ak. Ashwini P.K
- BD. B. Asha Dany
- BP. BALA PRIYA
- DS. Divya S
- DV. Dr.v.renuga
- DD. Dr. Renuka Desmukh
- D. Dr.K.GIINASEKARAN

Primary v/s Secondary Market : Key Differentiation

Features	Primary Market	Secondary Market
Definition	Securities issued first time to the public	Trading of already issued and listed securities
Also called as	New Issue Market	Post Issue Market
Price Determination	By Issuer Company in consultation with Merchant Bankers	Supply and Demand Forces of Market
Key Intermediaries	Merchant Bankers and RTAs	Stock Brokers and DPs
Purpose	Raise capital for expansion, diversification, etc.	Trading of securities Providing liquidity to investors.

Meeting Controls: Unmute, Start video, Share, Chat

ATTESTED

Dr. S. RAMABALAN, M.E., Ph.D.,
PRINCIPAL
 E.G.S. Pillay Engineering College,
 Thelhi, Nagore - 611 002.
 Nagapattinam (Dt) Tamil Nadu.

The program started with the greeting note and the welcome note by Dr. R. Karthi, Director of Management Studies Followed by which, the Resource person started their session. There were more than 60 participants attended the session.

She started the session by explaining the Securities Market.

Introduction to Securities Market

The securities markets provide a regulated framework for efficient flow of capital (equity and debt) from investors to business in the financial market system. Securities markets are basically a platform for allocation of savings to investments. Like any market, the securities market is also a place where buyers and sellers get

ATTESTED

DR. S. RAMABALAN, M.E., Ph.D.
PRINCIPAL
E.G.S. Pillay Engineering College,
Thethi, Nagore - 611 002,
Nagapattinam (Dt) Tamil Nadu.

Zoom Meeting | Meeting Info | Hide Menu Bar

File Edit Share View Audio & Video Participant Meeting Help

Participants (46)

Dr. R. EARTH P
Dr. E. Prabhakaran
Dr. v renuga
A. Abirha

SEBI's recent Investor Protection measures

E-KYC

- Online KYC Process
- Aadhaar authentication
- e-Sign signature framework

Power of Attorney (PoA)

- Not a compulsory document
- Only required for availing internet trading facility

Pledge/Re-pledge frameworks

- Acceptance of securities by way of pledge by client

Basic Services Demat Account (BSDA)

- Demat account at reduced costs
- For Retail Investors

Mutual Funds

- Product labeling on basis of risk associated with the scheme.

Unmute | Start video | Share

Zoom Meeting | Meeting Info | Hide Menu Bar

File Edit Share View Audio & Video Participant Meeting Help

Participants (45)

Dr. R. EARTH P
Dr. E. Prabhakaran
Dr. v renuga
A. Sowarna Lakshmi

Why Mutual Fund?

```

graph TD
    WHY((WHY?)) --- D((Diversification))
    WHY --- PM((Professional Management))
    WHY --- TA((Tax Advantages))
    WHY --- LL((Liquidity & Liquidity))
    WHY --- RP((Return Potential))
    WHY --- C((Convenience))
    
```

Unmute | Start video | Share

ATTESTED

(Signature)

Dr. S. RAMABALAN, M.E., Ph.D.
PRINCIPAL
 E.G.S. Pillay Engineering College,
 Thethi, Nagore - 611 002.
 Nagapattinam (Dt) Tamil Nadu.

together; the only difference being that the securities market also contributes to capital formation, apart from providing liquidity and price discovery. Due to the power of securities markets, the savings of households, business firms and government can be channelized to fund the capital requirements of a business enterprise.

Key Characteristics of Securities

Before we understand what are securities markets let us first understand what a Security is? A security could be a share / bond or any other financial instrument that has value or is linked to an underlying instrument that has value. According to the Securities Contracts Regulation Act (SCRA), a security is one that is exchange tradable. Here are some key features of securities; as applicable to financial markets.

- Securities represent the terms of exchange of money between two parties; the buyer and the seller in this case.
- Securities can be issued by borrowers / equity funders to raise money at a reasonable cost and gives security ownership to investors.
- Businesses issue securities to raise money from investor with surplus funds through a regulated contract and a regulated and monitored mechanism.
- While the issuer of the security provides the terms for raising capital, investors have a claim to the rights represented by the securities.
- Securities can be broadly classified into equity (risk participation) or debt (claim on cash flows).
- While debt securities are issued for a specific period, equity securities are perpetual. Debt securities pay interest while equity pays out dividends, but it is not assured.

Security Markets: Structure and Participants

Securities market can be broken up into three broad segments, although both are very closely inter-related.

- Primary market refers to the segment of the market where the securities are issued by companies either as a new issue or as an offer for sale. Both equity and debt securities have a primary market where they are first issued.
- Secondary markets are where the actual trading of these securities takes place. Primary issues of debt and equity eventually get traded in the secondary market for price discovery. The secondary market is the normal trading market.
- Derivatives market deals in futures and options. Unlike equities that signify ownership, derivatives are just contracts and are used to manage the risk underlying in the security. Traders can also trade in derivative contracts.

Let us now turn to the key participants in the securities market

Investors are individuals or institutions with surplus funds which are used to purchase securities. The objective of investors is to convert savings into financial investments. Such investors can be retail or institutional.

Issuers are the businesses or fund raisers looking to raise money by issuing securities. They issue securities for short-term and long-term capital needs of the business. Issuers include companies, governments, financial institutions, PSUs, mutual funds etc.

Other than the issuers and the investors who are the essential participants, there are a number of intermediaries who make the smooth functioning of securities market possible.

ATTESTED

Dr. S. RAMABALAN, M.E., Ph.D.
PRINCIPAL
E.G.S. Pillay Engineering College,
Thethi, Nagore - 611 002,
Nagapattinam (Dt) Tamil Nadu.

Key Intermediaries in the Securities Market

Intermediaries, as the name suggests, are agents coordinating between investors and issuers. SEBI (Intermediaries) Regulations, 2008, classifies intermediaries as follows.

- AMCs / Portfolio Managers manage a portfolio of securities and offer units that represent participation in a pool of money. They help investors diversify risk and build wealth.
- Investment bankers or lead managers manage IPOs, rights issues, debt raising, raising of FDs, and placement with institutions, syndication and give corporate advisory services too.
- Underwriters guarantee the sale of an IPO and give comfort to issuers by undertaking to take up shares that don't get sold. They are paid an underwriting fee for this service.
- Brokers are registered trading members of stock exchanges and they execute transactions in the secondary market. They also market IPOs and also give appropriate advice to clients.
- Sub-brokers / Franchisees are affiliated to brokers and help the brokers to reach out to a larger network of investors in specific geographies.
- Clearing members are members of the stock exchange who are responsible for the clearing and settlement of trades on a daily basis on the stock exchange.
- Bankers to an issue are appointed during IPOs, to collect application forms and monies from investors and coordinate with lead managers and facilitate transfer of funds.
- Registrars & Transfer Agents (RTAs) maintain the record of investors on behalf of the issuer. They manage allotment of IPOs, effect transfer of ownership and execute corporate actions.
- Depository Participants (DPs) are the link between the depository (NSDL/CDSL) and the investors. They hold the shares of investors in custody in electronic form.
- Custodians are to institutional investors what the DP is to retail investors. Custodians manage transactions pertaining to delivery of securities and money after a trade is made through the broker, and also provides accounting for securities and money.
- Trustees are appointed when beneficiaries may not be able to directly supervise if money invested is being managed properly. Mutual funds and debentures have trustees.
- Credit rating agencies rate a debt security based on the ability of the company to service its interest and principal obligations on time. Ratings are periodically reviewed.
- Investment advisers help investors to make an informed choice of securities in a manner that is in sync with their long term goals.

Regulatory Framework For The Securities Market

Regulation of the capital markets happens at multiple levels. There is a regulation by the nodal regulator, Securities, and Exchange Board of India (SEBI). Additionally, the securities markets are also regulated by the RBI, Department of Economic Affairs (DEA) of the Ministry of Finance and Ministry of Corporate Affairs (MCA). In addition, the stock exchanges and the depositories also exercise first level regulation of the securities market, apart from SEBI.

- Securities and Exchange Board of India (SEBI) is the principal regulator of the securities market and has 3 principal objectives viz. facilitating the growth of capital markets, protecting the interests of small investors and maintaining the integrity of markets.

ATTESTED

[Signature]
DR. S. RAMABALAN, M.E., Ph.D.,
PRINCIPAL
E.G.S. Pillay Engineering College,
Thethi, Nagore - 611 002.
Nagapattinam (Dt) Tamil Nadu.

- Reserve Bank of India (RBI) regulates the money market segment of the securities market. As the manager of the government's borrowing program, RBI is the issue manager for government debt. Exchange-traded currency futures also come under RBI purview.
- Ministry of Corporate Affairs (MCA) regulates the functioning of the corporate sector. It covers setting up of companies, functioning, audit and control. The issuance of securities is also subject to the provisions of the Companies Act 2013.
- Ministry of Finance (MOF) regulates markets through the Department of Economic Affairs. It broadly regulates capital markets and its participants and also initiates discussions on reforms and oversees the implementation of various governing acts.

Detailed Functions of SEBI

While SEBI broadly works to develop the market and to protect investor interest, its specific functions, inter alia, include the following.

- SEBI regulates the functioning of the stock exchanges and provides for direct or indirect control of all aspects of securities trading and functioning of stock exchanges. Stock exchanges are also required to send daily monitoring reports.
- SEBI has codified regulations that cover all activities and intermediaries in the securities markets, which includes brokers, sub brokers, investment bankers, depositories, depository participants, custodians, trustees, registrars etc.
- It oversees functioning of primary (IPO) markets. This includes general conditions for public and rights issuances, Institutional Placement Programme (IPP), Qualified Institutions Placement (QIP) etc; eligibility requirements, general obligations etc.
- Inspections of the intermediaries to ensure compliance with prescribed standards. SEBI can also order investigations into operations of any constituent of the securities market to prevent price manipulation, circular trading, insider trading, unfair practices etc.

Major Functions of The Securities Market

Securities markets are a barometer of the health and robustness of the economy and the investment scenario in the economy. Here are some of the key functions that securities markets perform.

- They enable efficient allocation of financial capital. By bringing investors, savers and issuers together, the securities market channel funds from those who are willing to take risk for the sake of returns to businesses that need capital to grow.
- Securities markets channelize the widespread and diverse savings of millions of small investors into long term wealth creation. Thus savings are productively employed enabling small investors to also participate in economic growth.
- An important function of securities market is that they provide liquidity to stocks and bonds that would have otherwise been illiquid. The availability of a liquid securities market also encourages investors and issuers to participate with greater confidence.
- Securities markets are an important platform for price discovery. Pricing of equities is lot more complex and securities markets manage to combine the wisdom of analysts, traders, investors and arbitrageurs to discover the real worth of an asset.

Dr. S. RAMABALAN, M.E., Ph.D.,
 PRINCIPAL
 E.G.S. Pillay Engineering College,
 Thethi, Nagore - 611 002,
 Nagapattinam (Dt) Tamil Nadu.

Securities Types And Characteristics

There are two broad types of securities that are issued by seekers of capital from investors:

- Equity
- Debt

While equity represents risk capital, debt represents more of an assured capital with lesser degree of risk. Equity capital has nothing like assured returns. Dividends are only paid out of profits and if the company performs well consistently then it also results in capital appreciation. Debt entails regular payment of interest as well as repayment of principal at the end of the tenure of the bond / debenture. Equity investors are the owners of the company while the debt investors are the creditors of the business. Equity investors can also participate in the management of the company and voting on resolutions.

Process of Investing In Equities

Equities offer a wide choice with over 4500 listed companies on the BSE. How do you go about selecting stocks to invest in? Here is the process.

Security selection: entails shortlisting of stocks based on screeners to reduce the sample. Then specific stock is selected based on business, future prospects, profit forecasts and intangible factors like management bandwidth and corporate governance.

Timing the market: is something you can do through the use of technical analysis. Charts are used to identify supports and resistances for stocks which guides on entry price, exit price and the price to place stop losses and reversal trades.

Industry group weighting: is suggested exposure to sectors like steel, automobiles, banking, IT, pharma etc and also to themes like high beta, cyclicals, brand strength, rate sensitives etc. Here is where sectoral risks come in.

Equity Research: is about in-depth research into the stock and institutional investors do very incisive in-house research before investing. Retail investors normally rely on their broker's research teams for research ideas on stocks.

Equity Valuation and Approaches to Equity Research

Equity valuation is the output and equity research is the process to get there. We will look at approaches to equity valuation first and then look at the equity research process. There are essentially two approaches to valuation:

- Discounted cash flow models
- Relative valuation models

Discounted cash flow (DCF) models are based on the premise that value can be estimated by projecting future cash flows. In the DCF model, the cash flows are projected for the next 5 years. Sales numbers are projected and then specific heads of income statement are also projected based on realistic assumptions. DCF relies on free cash flows that are the profit adjusted for non-cash items with a provision made for future capital expenditure. The future cash flows are discounted by the cost of capital. Another approach is the dividend discount approach, but that is not a very acceptable model for valuation.

Relative valuation models are based on comparison of ratios of apples and apples like companies in the same industry or business segment. Some of the popular tools of relative valuation are P/E ratio, P/S ratio, P/BV ratio, P/CF ratio, EV / EBITDA ratio, Dividend yield etc. Normally, the valuations arrived at through the DCF model are ratified by relative valuation parameters to ensure that valuations are not divorced from sector reality.

Having understood approaches to valuation, let us also look at the various approaches to equity research and analysis.

ATTESTED

Dr. S. RAMABALAN, M.E., Ph.D.
PRINCIPAL
E.G.S. Pillay Engineering College,
Theethi, Nagore - 611 002,
Nagapattinam (Dt) Tamil Nadu.

Fundamental analysis is the study of the financial statements and information pertaining to a stock, to estimate the future potential. Fundamental analysis can either be top down or bottom up. In top-down you start with the economy, then the industry and finally the company. In bottom up, you identify the company first and ratify with macro analysis. Bottom approach is more suited for mid cap stocks.

Technical analysis entails the study of price and volume charts to identify the right levels of entry and exit. Technicals are based on the principle that past patterns tend to repeat and hence future price movements can be estimated by studying past patterns.

Eclectic analysis is a combination of fundamental and technical analysis. Here fundamental analysis is used to identify the right stock and technical analysis used to time the entry and exit in the market to fine tune the trade. Eclectic is most commonly used in practice.

ATTESTED



Dr. S. RAMABALAN, M.E., Ph.D.
PRINCIPAL

E.G.S. Pillay Engineering College,
Thethi, Nagore - 611 002.
Nagapattinam (Dt) Tamil Nadu.

Event Feedback And Analysis

ATTESTED



Dr. S. RAMABALAN, M.E., Ph.D.,
PRINCIPAL

E.G.S. Pillay Engineering College,
Thethi, Nagore - 611 002.
Nagapattinam (Dt) Tamil Nadu.

Event Feedback Form created using Google Forms:

15:47

68%

Feedback on FDP
"Introduction to
Securities Market"
Sponsored by SEBI
and Organized by
E.G.S.Pillay
Engineering
College,
Nagapattinam

Dear Participants,

I thank all the participants for attending the FDP organized by Department of Management Studies, E.G.S.Pillay Engineering College, Nagapattinam. I request all the participants to fill the form. Certificate will send you to your mail ID.

Dr.R.Karthi
Director/MBA
E.G.S.Pillay Engineering College
(Autonomous)
Nagapattinam 611002

|||

○

<

ATTESTED

Dr. S. RAMABALAN, M.E., Ph.D.,
PRINCIPAL

E.G.S. Pillay Engineering College,
Thethi, Nagore - 611 002,
Nagapattinam (Dt) Tamil Nadu.

15:47

68%

Name (Ex: Dr.K.SIVASANTHOSH) *

Your answer

Designation *

- Assistant Professor
- Associate Professor
- Professor
- Head of the Department
- Director

Institution/College name *

Your answer

Organization of the session *

Excellent

|||

○

<

ATTESTED

Dr. S. RAMABALAN, M.E., Ph.D.
PRINCIPAL

E.G.S. Pillay Engineering College,
Thethi, Nagore - 611 002.
Nagapattinam (Dt) Tamil Nadu.

15:47

68%

Coverage of Topic *

- Excellent
- Very Good
- Good
- Average
- Fair

Content delivery of the Speakers

- Excellent
- Very Good
- Good
- Average
- Fair

Effectiveness of Discussion *

- Excellent
- Very Good

III

O

<

ATTESTED

Dr. S. RAMABALAN, M.E., Ph.D.,
PRINCIPAL
E.G.S. Pillay Engineering College,
Thethi, Nagore - 611 002.
Nagapattinam (Dt) Tamil Nadu.

15:47

4G 68%

Effectiveness of learning experience

*

- Excellent
- Very Good
- Good
- Average
- Fair

Any other Suggestions *

Your answer

Contact number *

Your answer

email *

ATTESTED



Dr. S. RAMADALAN, M.E., Ph.D.,
PRINCIPAL

E.G.S. Pillay Engineering College,
Thethi, Nagore - 611 002.

Nagapattinam (Dt) Tamil Nadu.

Feedback Procured from Students

Name of the Respondent	Designation	Institution/College name	Organization of the year	Course/level of the year	Content delivery	Quality of the content	Effectiveness of the content	Effectiveness of learning	Any other Suggestion
1. Dr. S. Ramabalan	Professor	E. G. S. Pillay Engineering College	Excellent	Excellent	Excellent	Excellent	Excellent	Excellent	Good
2. Dr. S. Ramabalan	Assistant Professor	E. G. S. Pillay Engineering College	Excellent	Excellent	Very Good	Very Good	Very Good	Very Good	Good
3. Dr. S. Ramabalan	Assistant Professor	E. G. S. Pillay Engineering College	Excellent	Excellent	Excellent	Excellent	Excellent	Excellent	Good
4. Dr. S. Ramabalan	Professor	E. G. S. Pillay Engineering College	Very Good	Very Good	Very Good	Very Good	Very Good	Very Good	Good
5. Dr. S. Ramabalan	Assistant Professor	A. C. M. College, Thiruvananthapuram	Excellent	Excellent	Very Good	Very Good	Very Good	Very Good	Good
6. Dr. S. Ramabalan	Assistant Professor	SRM Institute of Science and Technology	Excellent	Excellent	Very Good	Very Good	Very Good	Very Good	Good
7. Dr. S. Ramabalan	Assistant Professor	SRM Institute of Science and Technology	Excellent	Excellent	Very Good	Very Good	Very Good	Very Good	Good
8. Dr. S. Ramabalan	Assistant Professor	SRM Institute of Science and Technology	Excellent	Excellent	Very Good	Very Good	Very Good	Very Good	Good
9. Dr. S. Ramabalan	Assistant Professor	SRM Institute of Science and Technology	Excellent	Excellent	Very Good	Very Good	Very Good	Very Good	Good
10. Dr. S. Ramabalan	Assistant Professor	SRM Institute of Science and Technology	Excellent	Excellent	Very Good	Very Good	Very Good	Very Good	Good
11. Dr. S. Ramabalan	Assistant Professor	SRM Institute of Science and Technology	Excellent	Excellent	Very Good	Very Good	Very Good	Very Good	Good
12. Dr. S. Ramabalan	Assistant Professor	SRM Institute of Science and Technology	Excellent	Excellent	Very Good	Very Good	Very Good	Very Good	Good
13. Dr. S. Ramabalan	Assistant Professor	SRM Institute of Science and Technology	Excellent	Excellent	Very Good	Very Good	Very Good	Very Good	Good
14. Dr. S. Ramabalan	Assistant Professor	SRM Institute of Science and Technology	Excellent	Excellent	Very Good	Very Good	Very Good	Very Good	Good
15. Dr. S. Ramabalan	Assistant Professor	SRM Institute of Science and Technology	Excellent	Excellent	Very Good	Very Good	Very Good	Very Good	Good
16. Dr. S. Ramabalan	Assistant Professor	SRM Institute of Science and Technology	Excellent	Excellent	Very Good	Very Good	Very Good	Very Good	Good
17. Dr. S. Ramabalan	Assistant Professor	SRM Institute of Science and Technology	Excellent	Excellent	Very Good	Very Good	Very Good	Very Good	Good
18. Dr. S. Ramabalan	Assistant Professor	SRM Institute of Science and Technology	Excellent	Excellent	Very Good	Very Good	Very Good	Very Good	Good
19. Dr. S. Ramabalan	Assistant Professor	SRM Institute of Science and Technology	Excellent	Excellent	Very Good	Very Good	Very Good	Very Good	Good
20. Dr. S. Ramabalan	Assistant Professor	SRM Institute of Science and Technology	Excellent	Excellent	Very Good	Very Good	Very Good	Very Good	Good

Windows taskbar showing search bar, system tray with date 27-01-2021, and time 11:54.

Google Chrome browser tabs and address bar showing 'docs.google.com' and 'Untitled form (Responses)'.

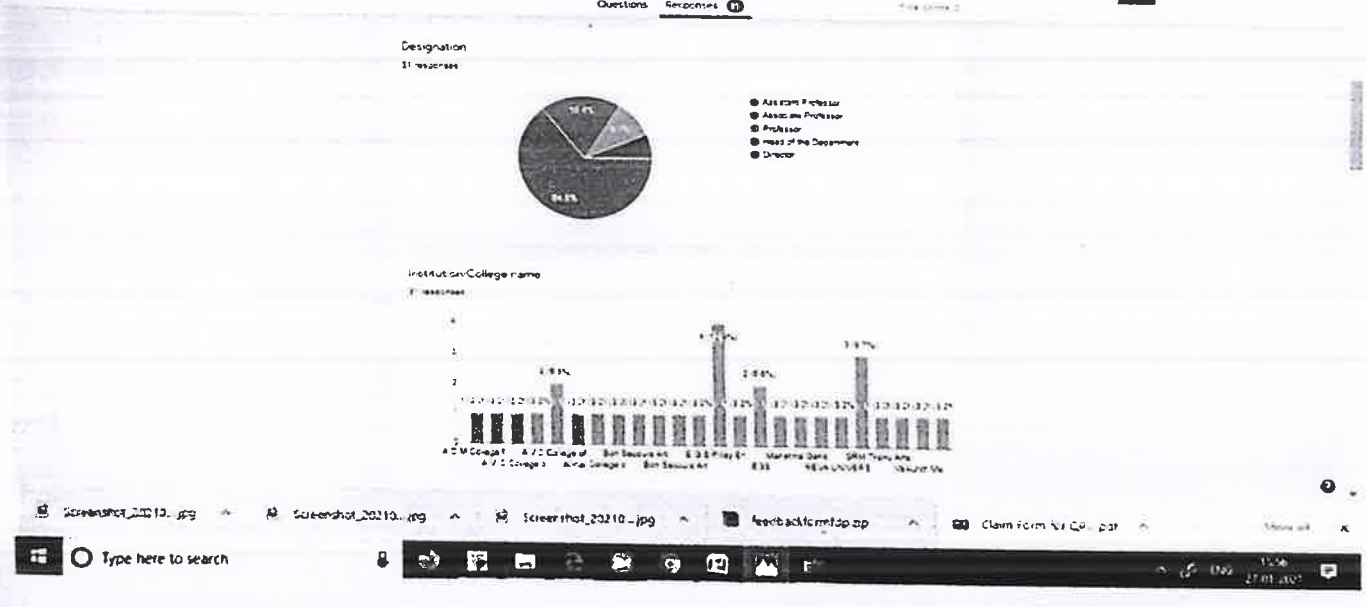

Windows taskbar showing search bar, system tray with date 27-01-2021, and time 11:56.

ATTESTED

Dr. S. RAMABALAN, M.E., Ph.D.,
PRINCIPAL
E.G.S. Pillay Engineering College,
Thethi, Nagore - 611 002.
Nagapattinam (Dt) Tamil Nadu.

Organization of the session
3 responses



- Excellent
- Very Good
- Average
- Fair

Coverage of Topic
3 responses



- Excellent
- Very Good
- Average
- Fair

Content delivery of the Speakers
3 responses



- Excellent
- Very Good
- Average
- Fair

Effectiveness of Discussion
3 responses



- Excellent
- Very Good
- Average
- Fair

ATTESTED

Dr. S. RAMABALAN, M.E., Ph.D.,
PRINCIPAL
E.G.S. Pillay Engineering College,
Thethi, Nagore - 611 002.
Nagapattinam (Dt) Tamil Nadu.

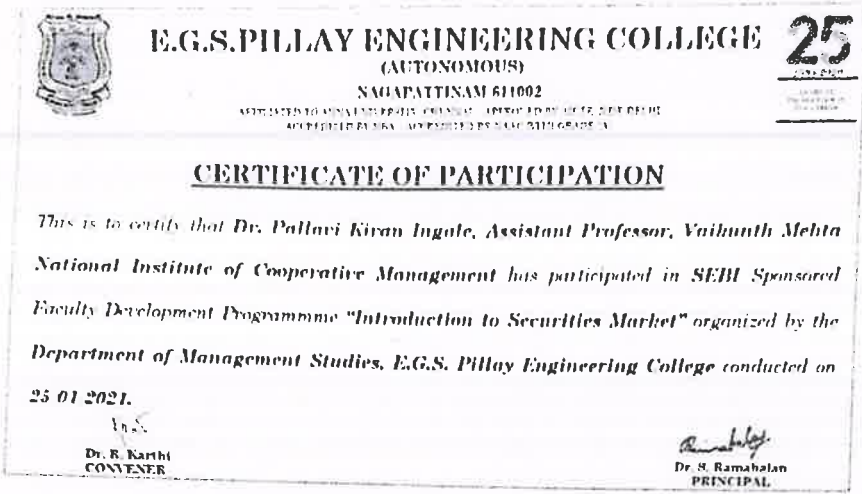

ATTESTED
[Signature]
Dr. S. RAMABALAN, M.E., Ph.D.,
PRINCIPAL
E.G.S. Pillay Engineering College,
Thathi, Nagore - 611 002.
Nagapattinam (Dt) Tamil Nadu.

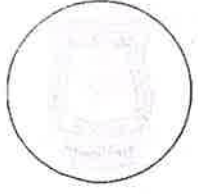

**E.G.S. PILLAY ENGINEERING
COLLEGE, NAGAPATTINAM**

(An Autonomous Institution)

Affiliated to Anna University, Chennai | Approved by AICTE, New Delhi
Accredited by NAAC with "A" Grade | An ISO 9001:2015 Certified Institution

25
YEARS OF
EXCELLENCE

Report on Guest Lecture
“EFFECTIVE COMMUNICATION “

By

Dr. R. MANIMOZHI

Organized by Department of Management Studies

Date: Monday, January 29, 2021

Time: 11:00 am to 12:00pm

Happened on Google Meet <https://meet.google.com/mfd-cvyj-mni>

ATTESTED

**Dr. S. RAMABALAN, M.E., Ph.D.,
PRINCIPAL**

**E.G.S. Pillay Engineering College,
Thethi, Nagore - 611 002.
Nagapattinam (Dt) Tamil Nadu.**

E.G.S. PILLAY ENGINEERING COLLEGE, NAGAPATTINAM
(An Autonomous Institution)

Affiliated to Anna University, Chennai | Approved by AICTE, New Delhi
Accredited by NAAC with "A" Grade | An ISO 9001:2015 Certified Institution

25
YEARS OF
EXCELLENCE

"EFFECTIVE COMMUNICATION "

An NCFE Sponsored Program

CONVENED BY : DR. R. KARTHI, Director, Department of Management Studies
COORDINATED BY : MR. S.K. SUDHAN, Assistant Professor, Department of
Management Studies
GUEST SPEAKER : DR. R. MANIMOZHI
CONDUCTED ON : January 29, 2021 between 11.00AM & 12.30PM



Coordinator

Mr. S.K. SUDHAN



Convenor

Dr. Karthi, Director/MBA

Dr. R. KARTHI

Director

Department of Management Studies
E.G.S. Pillay Engineering College
Nagapattinam - 611 002.

ATTESTED

Dr. S. RAMABALAN, M.E., Ph.D.,
PRINCIPAL

E.G.S. Pillay Engineering College,
Therthi Nagar, 611 002,
Nagapattinam (U) Tamil Nadu.

Contents

S. No	Description
1	Approval Letter
2	Acceptance Letter
3	Event Circular
4	Profile of Guest Speaker
5	Event Invitation
6	Participants Name List
7	Synopsis of the Event
8	Event Photos
9	Sample Feedback

ATTESTED

Dr. S. RAMABALAN, M.E., Ph.D.,
PRINCIPAL
E.G.S. Pillay Engineering College
Thethi, Nagore - 611 002.
Nagapattinam (Dt) Tamil Nadu

E.G.S. PILLAY ENGINEERING COLLEGE (AUTONOMOUS)

Department of management Studies

Circular

24-01-2021

This is to informed to that all faculty members Department of MBA going to conduct Guest Lecture on "Effective Communication" 29-01-2021 through online. All the faculty are requested to participate in this event.

Copy: All the faculty members EGSPEC



Director/MBA

Dr. R. KARTHI

Director

Department of Management Studies
E.G.S. Pillay Engineering College
Nagapattinam - 611 002.

ATTESTED



Dr. S. RAMABALAN, M.E., PH.D.

PRINCIPAL

E.G.S. Pillay Engineering College,

Thethi, Nagore - 611 002.

Nagapattinam (Dt) Tamil Nadu.

Profile of Guest Speaker



Name	Dr.(Mrs.) R.MANIMOZHI		
Designation	Assistant Professor of English / Vice Principal		
Qualification	M.A., M .Phil., Ph.D.,		
Age & DOB	43 years (as on January 2021) & 25.12.1977		
Date of first appointment	19.02.2007		
Date of joining in Govt.	19.02.2007		
Service			
Research Experience (years)	<ul style="list-style-type: none"> • Doctorate Degree was awarded in 27th May 2016. • 5years 		
Area of Research	<ul style="list-style-type: none"> • Indian Writing inEnglish. • Fictional World in Indian EnglishNovels • Feminism in Indian Writing inEnglish • Feministic Aspects in view ofHumanism • Comparative Study (Tradition VsModernity) • Psychological aspects innovels. • CommunicativeEnglish 		
Research Guidance (No.)		M. Phil	Ph .D
	Guided	-	-
	Guiding	-	01
			(Co-Guide, Annamalai University)

ATTESTED
Dr. S. RAMABALAN, M.E., Ph.D.,
PRINCIPAL
E.G.S. Pillay Engineering College,
Thethi, Nagore - 611 002.
Nagapattinam (Dt) Tamil Nadu.

Publication of Research Papers in Journals	<ul style="list-style-type: none"> • 11 research papers got published in International Peer Reviewed Journals / UGC Care Journals with ISSN number.
Publication of Research Articles in Books	<ul style="list-style-type: none"> • 10 Articles were published in Books with ISBN number. • One of the Editors of the book Lime Light – An Anthology of Prose, Biography, Poetry, Short Story and One Act Plays (5 Volumes)
Papers Presented in National / International Seminars / Conferences	<ul style="list-style-type: none"> • 25 Papers were presented in the National & International Seminar and Conferences
Major/Minor Projects	<ul style="list-style-type: none"> • Completed one Minor Research Project under UGC XII plan entitled: Emerging Womanhood in Githa Hariharan's <i>The Thousand Faces of Night and Fugitive Histories</i>
Conference Participation	<ul style="list-style-type: none"> • Participated in 26 National and International Seminars & Conferences to present papers. • Participated in U.G.C. sponsored Regional Workshop on Strategies and Techniques of Teaching Communication Skills to the Rural Learners at A.D.M.College for Women (Autonomous), Nagapattinam on 23rd & 24th July 2007. • Participated in U.G.C. sponsored National Seminar on Remote Sensing & Digital Image Processing at A.D.M.College for Women (Autonomous), Nagapattinam on 3rd & 4th July 2009.

ATTESTED

Dr. S. RAMABALAN, M.E., Ph.D.,
PRINCIPAL
E.G.S. Pillay Engineering College,
Thethi, Nagore - 611 002,
Nagapattinam (Dt) Tamil Nadu.

	<ul style="list-style-type: none"> • UGC Sponsored Three Day Symposium on New Vistas of Research in English Studies at National College (Autonomous) Tiruchirappalli on 6th to 8th March 2014. • Orientation Workshop on SWAYAM, jointly organized by Department of Library & Information Science and UGC – HRDC, Bharathidasan University, Tiruchirappalli at UGC – Human Resource Development Centre, Bharathidasan University, Khajamalai Campus, Tiruchirappalli on 29th June 2018 .
<p>Conference / Seminar Organized</p>	<ul style="list-style-type: none"> • Member of the Organizing Committee for conducting the UGC sponsored “Regional Workshop on Strategies and Techniques of Teaching Communication Skills to the Rural Learner” at A.D.M.College for Women, Nagapattinam, during 23rd & 24th July 2007. • Member of the Organizing Committee for conducting the UGC sponsored National Seminar on Environmental Concerns reflected in Indian Writing in English at A.D.M.College for Women, Nagapattinam on 10th & 11th April 2014. • Organizing Secretary – UGC sponsored Two Day National Workshop on “Functional English” at A.D.M.College for Women, Nagapattinam on 27th & 28th February 2020 .

ATTESTED

Dr. S. RAMABALAN, M.E., Ph.D.,
PRINCIPAL
 E.G.S. Pillay Engineering College,
 Thethi, Nagore - 611 002,
 Nagapattinam (Dt) Tamil Nadu.

	<ul style="list-style-type: none"> Organized 07 Faculty Development Programmes as IQAC Co-ordinator during 2017 – 2019.
Awards/ Honours Received	<ul style="list-style-type: none"> “ TamilSudar” award in 2009. ” Senthamizh Tilagam” award in 2011. “ ElakkiaSudar” award in 2012. “Senthamizh Ko” award in 2013.
Invited Talk	<ul style="list-style-type: none"> Motivational Speech at SKS Government School, Vedaranyam on 24th October 2018. Special Lecture on “Recent Trends in Indian Writing in English” in One Day National Level Conference on “Representation of New Directions in Indian Literature” at Bharathidasan University Model College, Vedaranyam on 19th December 2019. Special Invitee to initiate the steps to constitute IQAC and to speak on NAAC Criteria’s: An overview at Thiru. Vi. Ka. Government Arts College, Thiruvarur on 24th July 2019.
Extension Activities	<ul style="list-style-type: none"> Acted as Resource Person to teach Basics in English for 4th and 5th standard students at Nellukadai Middle School during the academic year 2009 – 2010.

ATTESTED

Dr. S. RAMABALAN, M.E., Ph.D.,
PRINCIPAL

E.G.S. Pillay Engineering College,
Thethi, Nagore - 611 002.
Nagapattinam (Dt) Tamil Nadu.

Event Invitation

e-Invite:

 **E.G.S. PILLAY ENGINEERING COLLEGE, NAGAPATTINAM**
(An Autonomous Institution)
Affiliated to Anna University, Chennai, Approved by AICTE, New Delhi,
Accredited by NAAC with "A" Grade, An ISO 9001:2015 Certified Institution



**DEPARTMENT OF MANAGEMENT STUDIES
ORGANIZES
AN ONLINE WORKSHOP ON
EFFECTIVE COMMUNICATION FOR MANAGERS**

Dr. R. MANIMOZHI,
Vice Principal & Associate Professor of English
ADM College of Women, Nagapattinam

Coordinator
Mr. S. Sathish Kumar
Asst. Prof/MBA

On
29-01-2021



At
11 AM

Convenor
Dr. R. Karthi
Director/MBA

 meet.google.com/bpt-chgo-tap

ATTESTED

Dr. S. RAMABALAN, M.E., Ph.D.,
PRINCIPAL
9 E.G.S. Pillay Engineering College,
Thethi, Nagore - 611 002.
Nagapattinam (Dt) Tamil Nadu.

Participants List:

S.NO	NAME	Designation
1	Dr.R.Karthi	Director/MBA
2	Dr.S.chandrasekar	Professor/MBA
3	Mr. R. Mohan Kumar	Associate Professor/MBA
4	Dr.B.Asha Daisy	Assistant Professor/MBA
5	Mr.S.Sakthi Kamal Nathan	Assistant Professor/MBA
6	Mr.S.Sathish Kumar	Assistant Professor/MBA
7	A. Sowarna Lakshmi	Assistant Professor/MBA
8	A.Umadevi	Assistant Professor/MBA
9	S.Mohamed Naina Maricar	Assistant Professor/MBA
10	I.Arulprakash	Assistant Professor/MBA
11	Mr.S.K.Sudhan	Assistant Professor/MBA
12	M. Sayee Sudha	Assistant Professor/MBA
13	R Deepa	HOD/ S&H
14	R.Seetha	Assistant Professor/S&H
15	V.Kavitha	Assistant Professor/S&H
16	Rajammal	Assistant Professor/CSE

ATTESTED

Dr. S. RAMABALAN, M.E., Ph.D.,
PRINCIPAL
E.G.S. Pillay Engineering College,
Thetni, Nagore - 611 002.
Nagapattinam (Dt) Tamil Nadu.

Welcome Note by Mr. S.K. SUDHAN,

Respected HOD sir Mr. Karthi,

Beloved faculty members,

Honorable Guest of the Day,

A warm Good Morning to all.

It's a great pleasure for me to introduce our speaker today, who is going to talk to us about,

“EFFECTIVE COMMUNICATION ”

Communication plays a vital role in every person's life, for example a new born child and a mother, between two friends, between managers and employees and so, on...

The result of communication may differ from among those above-mentioned group. A better communication always brings better result. As a management candidate it is very essential for to possess better communication skill.

Now is the time of opportunity to you all to gain the knowledge on how to possess a better communication skill. For the same let me introduce Mrs. Manimozhi,

To speak about her, she is an active Asst Professor and Vice Principal at ADM college-Nagapattinam, with qualification of M.A, M.Phil., Ph.D.

Her research experience involves many contributions in several areas like,

- Indian Writing inEnglish.
- Fictional World in Indian EnglishNovels.
- Feminism in Indian Writing inEnglish.
- Feministic Aspects in view ofHumanism.
- Comparative Study (Tradition VsModernity)
- Psychological aspects innovels.

Apart from that her contribution on publication are also mind blowing, she has published 11 research papers in international peer reviewed journals/ UGC care journals with ISSN number.

She has been awarded for,

- “Tamil Sudar” award in2009.
- ” SenthamizhTilagam” award in2011.

1

ATTESTED

Dr. S. RAMABALAN, M.E., Ph.D.,
PRINCIPAL
E.G.S. Pillay Engineering College,
Thethi, Nagore - 611 002.
Nagapattinam (Dt) Tamil Nadu.

- “ElakkiaSudar” award in2012.
- “Senthamizh Ko” award in2013.

So, let’s welcome Mrs.Manimozhi by giving her a big applause!

Synopsis of the event:

The program was convened by Dr. R. Karthi, Director and Head of the Department of Management Studies, E.G.S. Pillay Engineering College, coordinated by Mr. S. Sathish Kumar Assistant Professor, Department of Management Studies, E.G.S. Pillay Engineering College. In view of the covid-19 pandemic situation, the program was conducted online togainingknowledge learning and development

The program started with the greeting note by Dr. R. Karthi, Director of Management Studies and a welcome note by Mr. S.K. Sudhan, Assistant Professor. Followed by which, the guest speaker started her session.

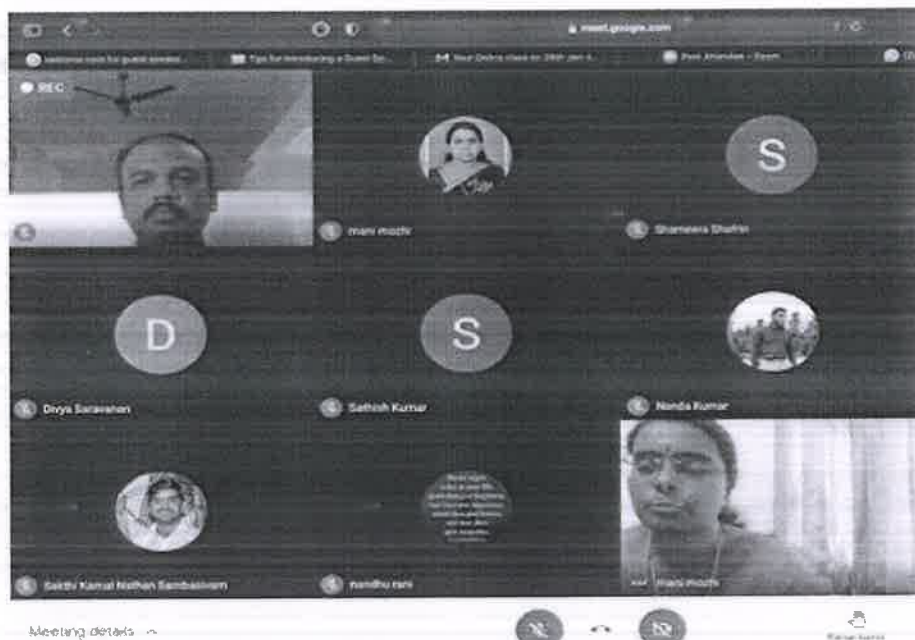

She started first by giving an introductory speech on self-confidence and belief with reference to SWAMI VIVEKANANDA’s sayings “Believe in yourself and the world will be at your feet” so as to encourage students.

The topic part went there on by explaining about verbal communication and its factors involved like,

ATTESTED

Dr. S. RAMABALAN, M.E., Ph.D.,
PRINCIPAL
E.G.S. Pillay Engineering College,
Thethi, Nagore - 611 002.
Nagapattinam (Dt) Tamil Nadu..

- Listening.
- Speaking.
- Reading
- Writing.

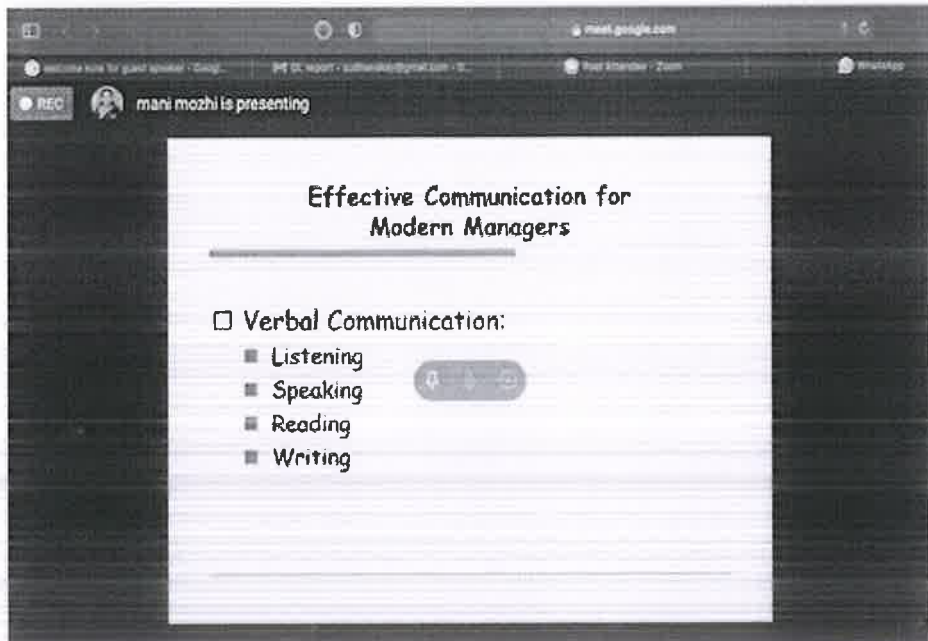

Secondly by explaining the non-verbal communication, body language, postures and gestures. Followed by a great speech on barriers for an effective communication.

ATTESTED
[Signature]
Dr. S. RAMABALAN, M.E., Ph.D.,
PRINCIPAL
E.G.S. Pillay Engineering College,
Thethi, Nagore - 611 002.
Nagapattinam (Dt) Tamil Nadu.

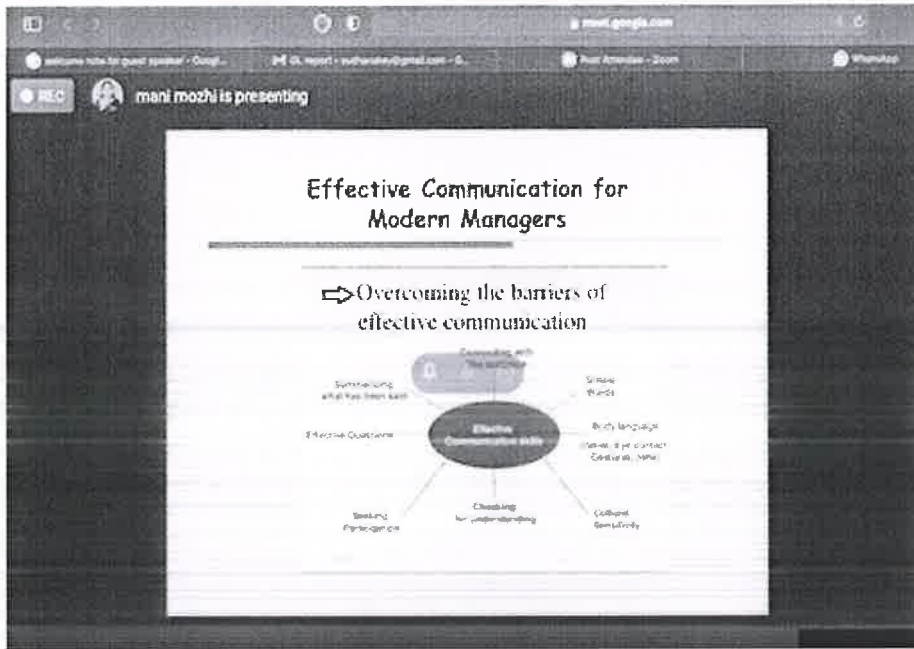

It is also very well understood from her speech that if there is barriers there will also be an even ways on how to overcome those barriers,

She then went on to conclude the speech by explaining about how a modern manager should behave in co-ordination with human resources, technological resources, financial resources within the context of the environment. Also, she spoke about the characteristics of a modern manager.

ATTESTED

Dr. S. RAMABALAN, M.E., Ph.D.,
PRINCIPAL
E.G.S. Pillay Engineering College,
Thethi, Nagore - 611 002.
Nagapattinam (Dt) Tamil Nadu.



EGS PILLAY

Group of Institutions

ENGINEERING | ARTS & SCIENCE | POLYTECHNIC | PHARMACY | B.ED., | INTERNATIONAL SCHOOL (CBSE)
Nagapattinam-611 002.



Certificate of Appreciation

This certificate is presented to

Dr. R. Manimozhi

in grateful recognition and sincere appreciation for sharing her valuable time and knowledge as Resource Speaker during the guest lecture programme on Effective Communication for Modern Managers on 29-01-2021 at Department of Management Studies, E.G.S. Pillay Engineering College (Autonomous), Nagapattinam

Dr.R.Karthi
Director/MBA

Dr.S.Ramabalan
Principal

ATTESTED

Dr. S. RAMABALAN, M.E., Ph.D.,
PRINCIPAL

E.G.S. Pillay Engineering College,
Thethi, Nagore - 611 002.
Nagapattinam (Dt) Tamil Nadu.

E.G.S PILLAY ENGINEERING COLLEGE, NAGAPATINAM

[AUTONOMOUS]

**(Approved by AICTE and Affiliated to Anna university)
(An ISO 9001-2015 certificated institution)
(Approved as Nodal Centre for Quality Improvement)**

Hands on Session

Of

Website Creation

Department of MCA



06.05.2021

<http://www.egspec.org>

COORDINATOR(S)

Dr.P.Arunkumar, AP/MCA

Mr.S.Selvaganapathy,AP/MCA

PHONE: 04364-25114

CONVENER

Dr. J.Vanitha, Professor /HOD/MCA

ATTESTED

**Dr. S. RAMABALAN, M.E., Ph.D.,
PRINCIPAL**

**E.G.S. Pillay Engineering College,
Thethi, Nagore - 611 002.
Nagapattinam (Dt) Tamil Nadu.**

E.G.S PILLAY ENGINEERING COLLEGE, NAGAPATINAM

[AUTONOMOUS]

(Approved by AICTE and Affiliated to Anna university)

(An ISO 9001-2015 certificated institution)

(Approved as Nodal Centre for Quality Improvement)

Hands on Session

Of

Website Creation

Department of MCA

S.NO	DETAILS	PAGE. No
1.	Agenda	01
2.	Permission letter	02
3.	Invitation	03
4.	circular	04
5.	Session Details	05
6.	Participants List	06
7.	Feedback	10
8.	Sample Certificate	14
9.	Sample photo	16

ATTESTED



**Dr. S. RAMABALAN, M.E., Ph.D.,
PRINCIPAL**

**E.G.S. Pillay Engineering College,
Thethi, Nagore - 611 002.
Nagapattinam (Dt) Tamil Nadu.**

E.G.S PILLAY ENGINEERING COLLEGE, NAGAPATINAM

[AUTONOMOUS]

**(Approved by AICTE and Affiliated to Anna university)
(An ISO 9001-2015 certificated institution)
(Approved as Nodal Centre for Quality Improvement)**

Department of MCA

Hands on Session

Of

Website Creation

06.05.2021

AGENDA

- ❖ **Welcome address.**
- ❖ **Introduction to resource person**
- ❖ **Online Website Creation 9.30 A.M to 11.00 A.M**

ATTESTED



**Dr. S. RAMABALAN, M.E., Ph.D.,
PRINCIPAL**

**E.G.S. Pillay Engineering College,
Thethi, Nagore - 611 002.
Nagapattinam (Dt) Tamil Nadu.**

Nagapattinam

02.05.2021

From

Dr.P.Arunkumar,AP/MCA

Mr.S.Selvaganapathy,AP/MCA,

E.G.S.Pillay Engineering College,

Nagapattinam.

To

Dr.J.Vanitha,Prof/HOD/MCA

E.G.S.Pillay Engineering College,

Nagapattinam.

Respected Madam,

Sub: Request to conduct Online Hands on Session Website Creation for Teaching and Non Teaching staff regarding.

The Staff members of MCA department are planning to arrange an Online Hands on Session for Website Creation for All staff members in Our College. 06.05.2021 .So we request you to give the permission to organize the program through Google Meet.

Thanking you,

Yours truly,

1. 

2. 



ATTESTED

Dr. S. RAMABALAN, M.E., Ph.D.,
PRINCIPAL

E.G.S. Pillay Engineering College,
Thethi, Nagore - 611 002.
Nagapattinam (Dt) Tamil Nadu.

E.G.S PILLAY ENGINEERING COLLEGE, NAGAPATINAM

[AUTONOMOUS]

**(Approved by AICTE and Affiliated to Anna university)
(An ISO 9001-2015 certificated institution)
(Approved as Nodal Centre for Quality Improvement)**

Department of MCA

Hands on Session

Of

Website Creation

06.05.2021

Cordially Invites you for the

CHIEF PATRON : Shri.S.Parameswaran, Secretary

**PATRON : Dr.S.Ramabalan, Principal, EGSPEC
Dr.V.Mohan,Vice Principal, EGSPEC**

**RESOURCE PERSON : Dr.K. Nancy Parkavi,Assistant Professor
School of Computer Science Engineering,VIT,Chennai**

ORGANIZER : Dr.J.Vanitha, HOD/MCA

**ORGANIZING SECRETARIES : Dr.P.Arunkumar, AP/MCA
Mr.S.Selvaganapathy,AP/MCA**

ATTESTED

**Dr. S. RAMABALAN, M.E., Ph.D.,
PRINCIPAL**

**E.G.S. Pillay Engineering College,
Thethi, Nagore - 611 002.
Nagapattinam (Dt) Tamil Nadu.**

E.G.S PILLAY ENGINEERING COLLEGE, NAGAPATINAM

[AUTONOMOUS]

**(Approved by AICTE and Affiliated to Anna university)
(An ISO 9001-2015 certificated institution)
(Approved as Nodal Centre for Quality Improvement)**

DEPARTMENT OF MCA

Circular Dated 04/05/2021

We are happy to inform that our MCA department is going to organize an Online Hands on Session of website creation on 06/05/2021 for all staff members of our Institution.

The Sessions are handled by Dr.K.Nancy Parkavi, AP/CSE, VIT, Chennai all the staff members are invited and join through the Google Meeting Link

Meeting link:



<https://meet.google.com/pyk-vbkf-xcy>

COORDINATORS
1. Dr.P.Arunkumar, AP/MCA
2. Mr.S.Selvaganapathy

CONVENER
[Dr.J.Vanitha, Prof/HOD/MCA]

ATTESTED

**Dr. S. RAMABALAN, M.E., Ph.D.,
PRINCIPAL
E.G.S. Pillay Engineering College,
Thethi, Nagore - 611 002.
Nagapattinam (Dt) Tamil Nadu.**

E.G.S PILLAY ENGINEERING COLLEGE, NAGAPATINAM

[AUTONOMOUS]

(Approved by AICTE and Affiliated to Anna university)

(An ISO 9001-2015 certificated institution)

(Approved as Nodal Centre for Quality Improvement)

Hands on Session

Of

Website Creation

06.05.2021

DEPARTMENT OF MCA

Session Details

Date & Time	Topic
06.05.2021, 9.30-11.00 Am	<ul style="list-style-type: none">➤ Introduction about Weebly website➤ Step by step Website creation procedure➤ How Insert the pictures and images into the webpage➤ Demo for sample web site

ATTESTED

**Dr. S. RAMABALAN, M.E., Ph.D.,
PRINCIPAL**

**E.G.S. Pillay Engineering College,
Thethi, Nagore - 611 002.
Nagapattinam (Dt) Tamil Nadu.**

E.G.S PILLAY ENGINEERING COLLEGE, NAGAPATINAM
[AUTONOMOUS]
(Approved by AICTE and Affiliated to Anna university)
(An ISO 9001-2015 certificated institution)
(Approved as Nodal Centre for Quality Improvement)

Hands on Session
Of
Website Creation
06.05.2021
Department of MCA
Participants List

S.NO	Staff Name	Department Name
1	B.Shanmugam	Library
2	R.Mathurabashini	Library
3	R.Sumathi	Library
4	M.Hemalatha	Library
5	D.Prince Ayya	Principal Office
6	R.Shanmugam	Principal Office
7	S.Selvaganapathy	MCA
8	N.Ilakkiya	MCA
9	S.Visalatchy	MCA
10	M.Rajeshwar	MCA
11	R.Vetriselvan	MCA
12	A.Hema	MCA

ATTESTED

Dr. S. RAMABALAN, M.E., Ph.D.,
PRINCIPAL

E.G.S. Pillay Engineering College,
Thethi, Nagore - 611 002.
Nagapattinam (Dt) Tamil Nadu.

13	C.Mallika	MCA
14	P.Arunkumar	MCA
15	D.Velavan	Principal Office
16	Mr. V.M.Suresh	IT
17	Mrs. R.G.Gokila	IT
18	Mr. R.Anand Babu	IT
19	Mrs. R.Lavanya	IT
20	Mr. K.Raju	IT
21	Mrs. P.Ponnaruvi	IT
22	P.Muthunayakam	IT
23	Mr.R.Sundar	Mechanical
24	Mr.G.Surendar	Mechanical
25	Mr.V.Manathuanai Nathan	Mechanical
26	Mr.G.Sundaravadivel	Mechanical
27	Mr.B.ManiKandan	Mechanical
28	Mr.K.Senthil Nathan	Mechanical
29	P.Sudhamathy	Account Office
30	S.Gopinath	Account Office
31	J.Kasthuri	Account Office
32	S.Sakthivel	Mechanical
33	S.Venkatesan	Mechanical

ATTESTED

Dr. S. RAMABALAN, M.E., Ph.D.,
PRINCIPAL

E.G.S. Pillay Engineering College,
Thethi, Nagore - 611 002.
Nagapattinam (Dt) Tamil Nadu.

34	K.Raju	ECE
35	S.Vijayasankar	SAH
36	T.Gopi	EEE
37	I.Arul Prakash	T&P
38	R.Ramya	T&P
39	Mrs.K.Kamalarani	Civil
40	Mr.T.Adhavanathan	Civil
41	Mr.S.Shyam Sundar	Civil
42	Mr.E.Venkatesan	Civil
43	T. Senthilkumar	ECE
44	Mrs.J.Menaka	EEE
45	Mr.V.Yokeswaran	EEE
46	S. Aadhirai	ECE
47	S. Suganya	ECE
48	R. Keerthika	ECE
49	P. Panchali	ECE
50	M.Viji	CSE
51	G.Bakya	CSE
52	P.Swathi	CSE
53	Mr.S.Mohamed NainaMaricar	MBA
54	Mr.S.Sathish kumar	MBA

ATTESTED

**Dr. S. RAMABALAN, M.E., Ph.D.,
PRINCIPAL**

**E.G.S. Pillay Engineering College,
Thethi, Nagore - 611 002.
Nagapattinam (Dt) Tamil Nadu.**

55	Ms.A.Sowarnalakshmi	MBA
56	Ms.P.Tamilazhaghi	MBA
57	Ms.N.Rajeshwari	MBA
58	Mrs.M.Mary Vincy	MBA
59	Dhanasekaran R	S&H
60	Malathi S	S&H
61	R.Kiruthika	BME
62	K.Kalanithi	BME

ATTESTED



**Dr. S. RAMABALAN, M.E., Ph.D.,
PRINCIPAL**

**E.G.S. Pillay Engineering College,
Thethi, Nagore - 611 002.
Nagapattinam (Dt) Tamil Nadu.**

E.G.S PILLAY ENGINEERING COLLEGE, NAGAPATINAM
[AUTONOMOUS]
(Approved by AICTE and Affiliated to Anna university)
(An ISO 9001-2015 certificated institution)
(Approved as Nodal Centre for Quality Improvement)

Hands on Session
Of
Website Creation
06.05.2021
Department of MCA
Feedback

The image shows a screenshot of a Google Forms page. The browser address bar at the top displays "docs.google.com/forms/d/e/". The form content includes the college name "E.G.S.PILLAY ENGINEERING COLLEGE[AUTONOMOUS],NAGAPATTINAM" and the department "DEPARTMENT OF MCA". The form title is "HANDS ON SESSION WEBSITE CREATION FEEDBACK FORM". It shows the user's email as "surya@egspec.org (not shared)" with a "Switch account" option. A red asterisk indicates a required field. The first question is "Enter your Name(eg: Dr/Mr/Mrs Jeba E)" with a text input field containing "Your answer". The second question is "How would you rate your ability to give constructive criticism to achieve your desired outcomes?" with a red asterisk and a dropdown menu.

ATTESTED

Dr. S. RAMABALAN, M.E., Ph.D.,
PRINCIPAL
E.G.S. Pillay Engineering College,
Thethi, Nagore - 611 002.
Nagapattinam (Dt) Tamil Nadu.

How would you rate your ability to give constructive criticism to achieve your desired outcomes?

- Excellent
- Very Good
- Good
- Average

How about Workshop practical session *

- Excellent
- very Good
- Good
- Average

The Objectives/expected outputs of the workshop achieved *

- Excellent
- Very Good
- Good
- Average

ATTESTED



**Dr. S. RAMABALAN, M.E., Ph.D.,
PRINCIPAL**

E.G.S. Pillay Engineering College,
Thethi, Nagore - 611 002.
Nagapattinam (Dt) Tamil Nadu.

Average

Overall how do you rate this workshop *

Excellent

Very Good

Good

Average

How satisfied were you with the workshop? *

Excellent

very good

good

Average

Submit

Clear form

Never submit passwords through Google Forms.

This form was created inside of E.G.S. Pillay Engineering College. [Report Abuse](#)

Google Forms

ATTESTED

Dr. S. RAMABALAN, M.E., Ph.D.,
PRINCIPAL
E.G.S. Pillay Engineering College,
Thethi, Nagore - 611 002.
Nagapattinam (Dt) Tamil Nadu.

E.G.S PILLAY ENGINEERING COLLEGE, NAGAPATINAM
[AUTONOMOUS]
(Approved by AICTE and Affiliated to Anna university)
(An ISO 9001-2015 certificated institution)
(Approved as Nodal Centre for Quality Improvement)

Hands on Session
Of
Website Creation
06.05.2021
Department of MCA
Feedback

E.G.S.Pillay Engineering College(Autonomous),Nagapattinam						
Hands on Session of Website Creation						
Feedback						
Timestamp	Enter your Name	How would you rate your ability to give constructive criticism to achieve your desired outcomes?	How about Workshop practical session	The Objectives /expected outputs of the workshop achieved	Overall how do you rate this workshop	How satisfied were you with the workshop?
6-5-2021 11:08:15	Mr. V.M.Suresh	Excellent	very good	Good	Very Good	Excellent
6-5-2021 11:08:16	Mr.V.Manathuanai Nathan	Excellent	Excellent	very good	Good	Very Good
6-5-2021 11:08:17	S.Gopinath	Good	very good	Good	Very Good	Excellent
6-5-2021 11:08:18	Mr.S.Shyam Sundar	Excellent	Very Good	very good	Good	Very Good
6-5-2021 11:08:25	Mr.V.Yokeswaran	Excellent	Very Good	very good	Good	Very Good
6-5-2021 11:08:29	Mrs. R.G.Gokila	Good	very good	Good	Very Good	Excellent
6-5-2021 11:08:35	Mr.G.Surendar	Good	very good	Good	Very Good	Good
6-5-2021 11:08:39	Mr.K.Senthil Nathan	Excellent	very good	Good	Very Good	Very Good
6-5-2021 11:08:45	S.Venkatesan	Very Good	very good	Good	Very Good	Excellent
6-5-2021 11:08:55	S. Aadhirai	Very Good	Very Good	Good	Very Good	Good
6-5-2021 11:09:15	Mr.E.Venkatesan	Very Good	very good	Good	Very Good	Excellent
6-5-2021 11:09:25	S.Vijayasankar	Very Good	Very Good	very good	Good	Very Good
6-5-2021 11:09:30	Mr. R.Anand Babu	Excellent	very good	Good	Very Good	Excellent
6-5-2021 11:09:36	Mrs. P.Ponnaruvi	Good	very good	Good	Very Good	very good
6-5-2021 11:09:37	Mrs. R.Lavanya	Good	Good	Very Good	Excellent	very good
6-5-2021 11:09:39	Mr.G.Sundaravadivel	Very Good	Very Good	Very Good	Excellent	Very Good
6-5-2021 11:09:45	P.Sudhamathy	Very Good	Good	Very Good	Excellent	Very Good
6-5-2021 11:09:55	K.Raju	Very Good	Good	Very Good	Excellent	Very Good
6-5-2021 11:10:05	Mr.R.Sundar	Excellent	very good	Good	Very Good	Excellent
6-5-2021 11:10:01	P.Muthunayakam	Good	Very Good	very good	Good	Very Good
6-5-2021 11:10:05	Mr. K.Raju	Excellent	Very Good	very good	Good	Very Good

ATTESTED

Dr. S. RAMABALAN, M.E., Ph.D.,
PRINCIPAL

E.G.S. Pillay Engineering College,
Thethi, Nagore - 611 002.

6-5-2021 11:10:06	Mr.B.ManiKandan	Excellent	Good	Very Good	Excellent	Very Good
6-5-2021 11:10:01	I.Arul Prakash	Excellent	very good	Good	Very Good	Excellent
6-5-2021 11:10:01	T. Senthilkumar	Very Good	Good	Very Good	Excellent	Very Good
6-5-2021 11:10:01	R. Keerthika	Very Good	Good	Very Good	Excellent	Very Good
6-5-2021 11:10:01	M.Viji	Very Good	Good	Very Good	Excellent	Very Good
6-5-2021 11:10:01	J.Kasthuri	Very Good	very good	Good	Very Good	Excellent
6-5-2021 11:10:01	S.Sakthivel	Excellent	very good	Good	Very Good	Excellent
6-5-2021 11:10:01	Ms.N.Rajeshwari	Excellent	Good	Very Good	Excellent	Very Good
6-5-2021 11:10:01	G.Bakya	Excellent	Good	Very Good	Excellent	Very Good
6-5-2021 11:10:07	T.Gopi	Excellent	very good	Good	Very Good	Excellent
6-5-2021 11:10:10	Mr.T.Adhavanathan	Excellent	Good	Very Good	Excellent	Very Good
6-5-2021 11:10:13	Mr.S.Sathish kumar	Very Good	very good	Very Good	Excellent	Very Good
6-5-2021 11:10:15	B.Shanmugam	Very Good	very good	Good	Very Good	Excellent
6-5-2021 11:10:16	M.Hemalatha	Excellent	very good	Good	Very Good	Excellent
6-5-2021 11:10:16	S.Selvaganapathy	Excellent	Good	Very Good	Excellent	Very Good
6-5-2021 11:10:18	S.Visalatchy	Very Good	very good	Good	Very Good	Excellent
6-5-2021 11:10:18	R.Vetriselvan	Excellent	very good	Good	Very Good	Excellent
6-5-2021 11:10:20	C.Mallika	Excellent	Good	Very Good	Excellent	Very Good
6-5-2021 11:10:27	D.Prince Ayya	Excellent	very good	Good	Very Good	Excellent
6-5-2021 11:10:29	R.Mathurabashini	Excellent	very good	Good	Very Good	Excellent
6-5-2021 11:10:32	R.Sumathi	Excellent	very good	Good	Very Good	Excellent

ATTESTED

**Dr. S. RAMABALAN, M.E., Ph.D.,
PRINCIPAL**

**E.G.S. Pillay Engineering College,
Thethi, Nagore - 611 002.
Nagapattinam (Dt) Tamil Nadu.**

**E.G.S PILLAY ENGINEERING COLLEGE, NAGAPATINAM
[AUTONOMOUS]**

(Approved by AICTE and Affiliated to Anna university)

(An ISO 9001-2015 certificated institution)

(Approved as Nodal Centre for Quality Improvement)

Hands on Session

Of

Website Creation

06.05.2021

Sample Certificate



CERTIFICATE

OF PARTICIPANTS

This is certify that

Mr.S.Sathish kumar

Assistant Professor,MBA,has attended Online Hands on Session of Website Creation organized by Department of MCA,E.G.S.Pillay Engineering College[Autonomous]Nagapattinam,Tamilnadu 06/05/2021

Coordinator(s)

Dr.P.Arunkumar,AP/MCA
Mr.S.Selvaganapathy,AP/MCA



Convener

Dr.J.Vanitha,Professor/HOD

Made with PosterMyWall.com

ATTESTED

[Signature]
Dr. S. RAMABALAN, M.E., Ph.D.,
PRINCIPAL
E.G.S. Pillay Engineering College,
Thethi, Nagore - 611 002.
Nagapattinam (Dt) Tamil Nadu.

E.G.S PILLAY ENGINEERING COLLEGE, NAGAPATINAM

[AUTONOMOUS]

(Approved by AICTE and Affiliated to Anna university)
(An ISO 9001-2015 certificated institution)
(Approved as Nodal Centre for Quality Improvement)

Hands on Session

Of

Website Creation

06.05.2021

Department of MCA

Screen Shot

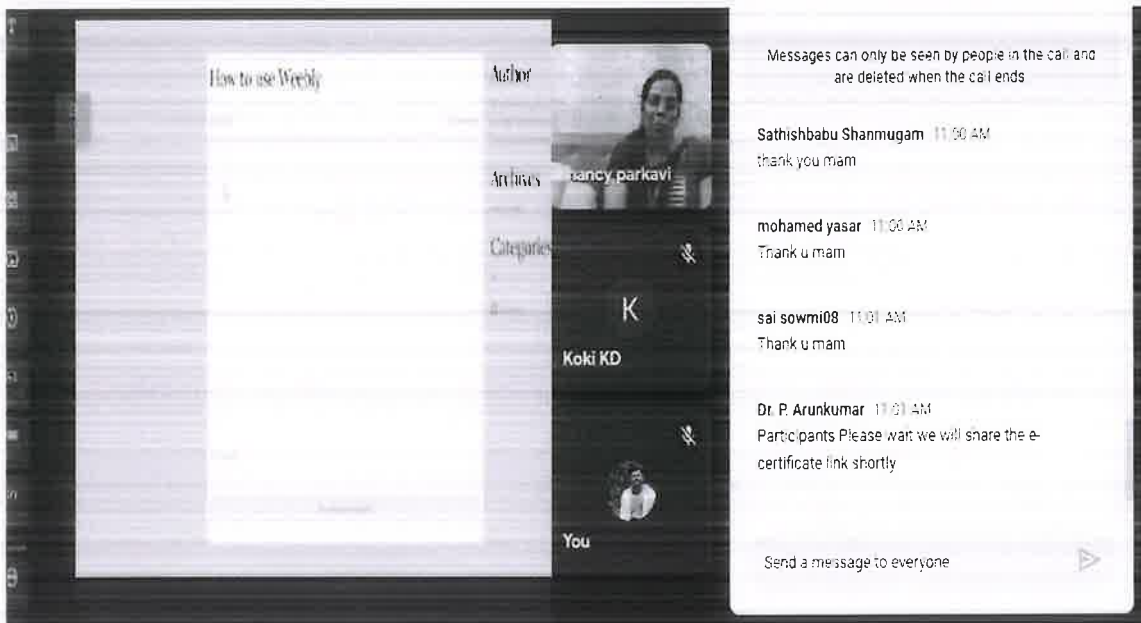

ATTESTED

**Dr. S. RAMABALAN, M.E., Ph.D.,
PRINCIPAL**

**E.G.S. Pillay Engineering College,
Thethi, Nagore - 611 002.
Nagapattinam (Dt) Tamil Nadu.**

E.G.S PILLAY ENGINEERING COLLEGE, NAGAPATINAM

[AUTONOMOUS]

(Approved by AICTE and Affiliated to Anna university)

(An ISO 9001-2015 certificated institution)

(Approved as Nodal Centre for Quality Improvement)

Hands on Session

Of

Website Creation

06.05.2021

Department of MCA

Screen Shot

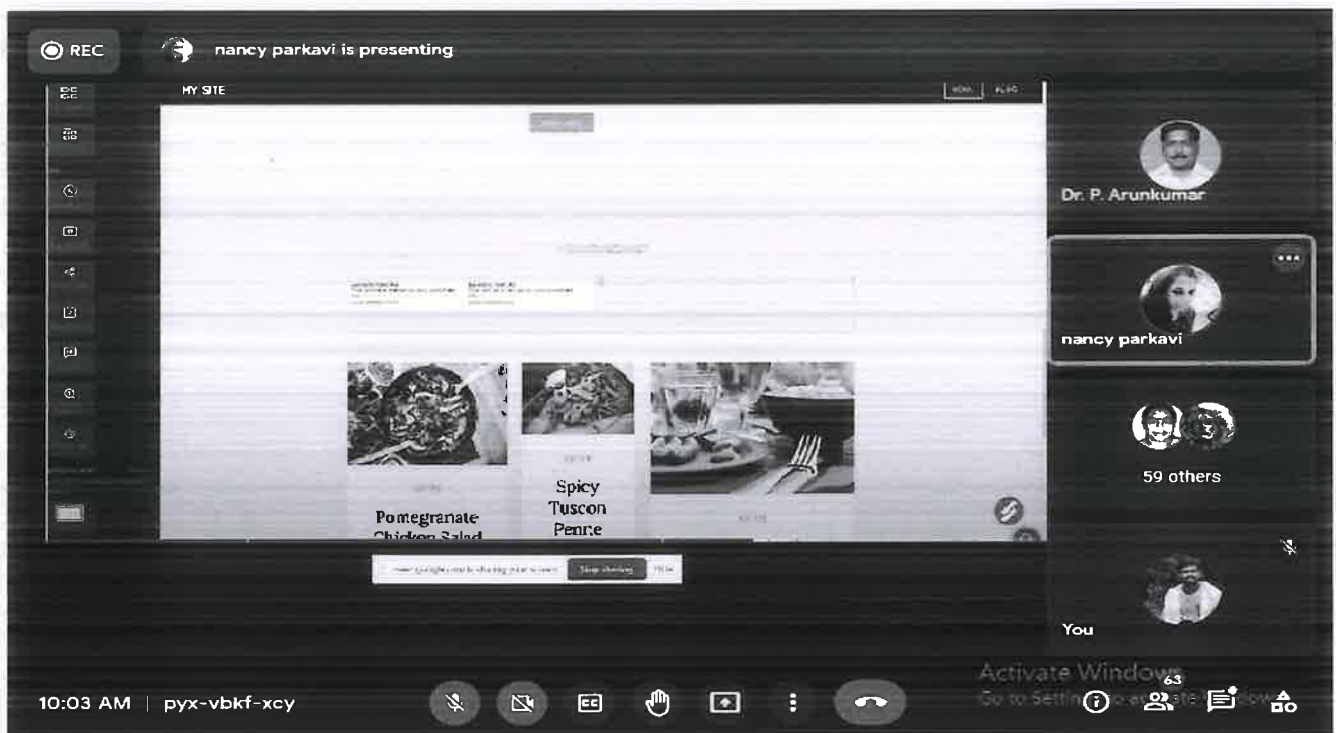

ATTESTED

Dr. S. RAMABALAN, M.E., Ph.D.,
PRINCIPAL
E.G.S. Pillay Engineering College,
Thethi, Nagore - 611 002.
Nagapattinam (Dt) Tamil Nadu.

E.G.S.PILLAY ENGINEERING COLLEGE,[AUTONOMOUS]NAGAPATTINAM – 611002

Approved by AICTE,New Delhi | Affiliated to Anna University,Chennai

Accredited by NAAC with 'A' Grade | An ISO 9001:2015 Certified Institution

Nagapattinam – 611001 Tamil Nadu India

Ph: 04365 -251112 / 251114 | E-mail:enquiries@egspec.org | Website : WWW.egspec.org

ONLINE WEBINAR On AWS

23.04.2021

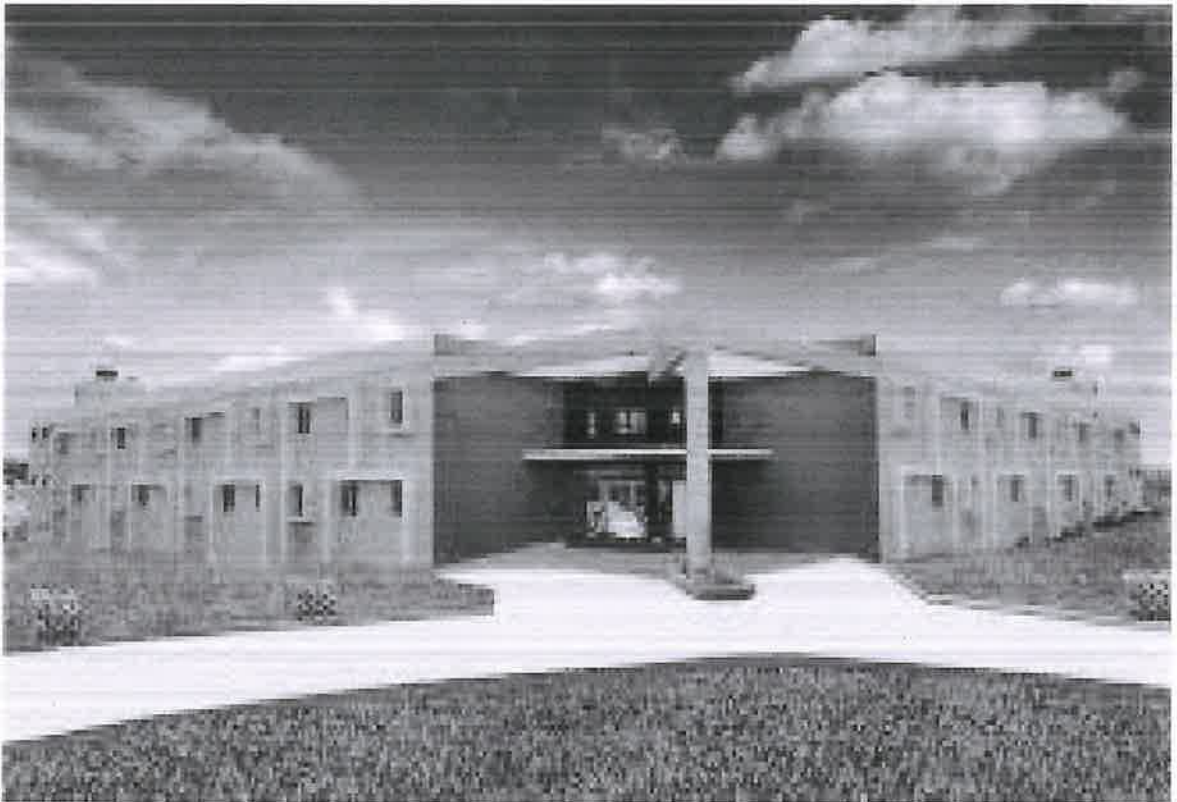

Coordinators

- 1. Mrs. C. Mallika, Assoc.Prof /MCA**
- 2. Mrs. A.Hema, Asst.Prof/MCA**
- 3.Mrs.S.Visalatchy,Asst.Prof/MCA**

Convener

(Dr. J.Vanitha, Professor /MCA)

ATTESTED

Prof.

**Dr. S. RAMABALAN, M.E., Ph.D.,
PRINCIPAL**

**E.G.S. Pillay Engineering College,
Thethi, Nagore - 611 002.**

Nagapattinam (Dt) Tamil Nadu.

E.G.S.PILLAY ENGINEERING COLLEGE,[AUTONOMOUS]NAGAPATTINAM – 611002

Approved by AICTE,New Delhi |Affiliated to Anna University,Chennai

Accredited by NAAC with 'A' Grade | An ISO 9001:2015 Certified Institution

Nagapattinam – 611001 Tamil Nadu India

Ph: 04365 -251112 / 251114 | E-mail:enquiries@egspec.org | Website : WWW.egspec.org

ONLINE WEBINAR on AWS

23.04.2021

S.No	Details	Page No
1.	Invitation	1
2.	Agenda	2
3.	Permission Letter	3
4.	Session Details	4
5.	Feedback Form	5
6.	Sample Photos	8
7.	Sample Certificate	11

ATTESTED



**Dr. S. RAMABALAN, M.E., Ph.D.,
PRINCIPAL**

**E.G.S. Pillay Engineering College,
Thethi, Nagore - 611 002.
Nagapattinam (Dt) Tamil Nadu.**

E.G.S.PILLAY ENGINEERING COLLEGE,[AUTONOMOUS]NAGAPATTINAM – 611002

Approved by AICTE,New Delhi | Affiliated to Anna University,Chennai

Accredited by NAAC with 'A' Grade | An ISO 9001:2015 Certified Institution

Nagapattinam – 611001 Tamil Nadu India

Ph: 04365 -251112 / 251114 | E-mail:enquiries@egspec.org | Website : WWW.egspec.org

Cordially Invites you for the

ONLINE WEBINAR ON AWS

23.04.2021

Resource Person

Mr.P.V.N.S.L.S.S.R.Murthy ME.,(Ph.D.)

Senior Product Manager

Anubavam Technology,Chennai

Organized by

Department of MCA

Will preside over the function

**Ramabalan
Principal,EGSPEC**

**Mrs.J.Vanitha
HOD /MCA**

ATTESTED

**Dr. S. RAMABALAN, M.E., Ph.D.,
PRINCIPAL**

E.G.S. Pillay Engineering College,

Thethi, Nagore - 611 002.

Nagapattinam (Dt) Tamil Nadu.

**E.G.S.PILLAY ENGINEERING COLLEGE, [AUTONOMOUS] NAGAPATTINAM –
611002**

**Approved by AICTE, New Delhi | Affiliated to Anna University, Chennai
Accredited by NAAC with 'A' Grade | An ISO 9001:2015 Certified Institution
Nagapattinam – 611001 Tamil Nadu India**

Ph: 04365 -251112 / 251114 | E-mail:enquiries@egspec.org | Website : WWW.egspec.org

ONLINE WEBINAR ON AWS

On

23.04.2021

AGENDA

Date	Time	Program
	10.00 A.M– 10.10 A.M	Welcome Address
	10.10 A.M– 11.40 A.M	Session1
	11.40 A.M– 12.00 P.M	Interactive Session
23.04.2021	12.00 P.M– 12.30 P.M	Feedback Session
	12.30 P.M– 12.40 P.M	Vote of Thanks

ATTESTED



**Dr. S. RAMABALAN, M.E., Ph.D.,
PRINCIPAL**

**E.G.S. Pillay Engineering College,
Thethi, Nagore - 611 002.
Nagapattinam (Dt) Tamil Nadu.**

Nagapattinam

19.04.2021

From

Mrs.C.Mallika,
Associate Professor/ MCA,
E.G.S.Pillay Engineering College,
Nagapattinam.

To

The Principal,
E.G.S.Pillay Engineering College,
Nagapattinam.

Thru

Dr.J.Vanitha,
Professor & HOD / MCA,
E.G.S.Pillay Engineering College,
Nagapattinam

Respected Sir,

Sub: Permission to organize Online Webinar – Reg.

Our Department is to plan to organize the Online Webinar in AWS . So, I kindly request you to give permission for organizing the Online Webinar on 23.04.2021.

Thanking you,

yours truly,

[Mrs.C.Mallika]

ATTESTED

Dr. S. RAMABALAN, M.E., Ph.D.,
PRINCIPAL
E.G.S. Pillay Engineering College,
Thethi, Nagore - 611 002.
Nagapattinam (Dt) Tamil Nadu.

E.G.S.PILLAY ENGINEERING COLLEGE,[AUTONOMOUS]NAGAPATTINAM – 611002
Approved by AICTE,New Delhi | Affiliated to Anna University,Chennai
Accredited by NAAC with 'A' Grade | An ISO 9001:2015 Certified Institution
Nagapattinam – 611001 Tamil Nadu India
Ph:04365 -251112 / 251114 | E-mail:enquiries@egspec.org | Website : WWW.egspec.org

ONLINE WEBINAR ON AWS

23.04.2021

Session Details

Date	I Session 10.00 a.m. to 12.00 p.m
23.04.2021	<ul style="list-style-type: none">❖ Introduction AWS❖ Event Controls of AWS❖ Explore AWS❖ AWS Cloud❖ Account creation in AWS-Demo

ATTESTED

Dr. S. RAMABALAN, M.E., Ph.D.,
PRINCIPAL

E.G.S. Pillay Engineering College,
Thethi, Nagore - 611 002.
Nagapattinam (Dt) Tamil Nadu.

E.G.S.PILLAY ENGINEERING COLLEGE,[AUTONOMOUS]NAGAPATTINAM – 611002

Approved by AICTE,New Delhi |Affiliated to Anna University,Chennai

Accredited by NAAC with 'A' Grade | An ISO 9001:2015 Certified Institution

Nagapattinam – 611001 Tamil Nadu India

Ph: 04365 -251112 / 251114 | E-mail:enquiries@egspec.org | Website : WWW.egspec.org

ONLINE WEBINAR On AWS

23.04.2021

Feedback

Timestamp	Enter Name	How satisfied were you with the event?	How would you rate the content of the webinar?	The presentation delivery system was stable and met the needs of the attendees	The presentation material contributed to understanding the subject matter.	How satisfied were you with the session content?	The presenter (s) explained concepts clearly and understandably.	overall feedback for the event?
23-04-2021 12:06	Ms.B.Sangeetha,	5	4	4	5	4	5	good
23-04-2021 12:06	Mr. K. Ganesan,	4	5	5	5	5	5	Super
23-04-2021 12:06	Ms.A.Bhuvaneshwari,	5	5	5	5	5	5	Super
23-04-2021 12:06	Mrs.Hema,	5	5	5	5	5	5	Useful for information
23-04-2021 12:06	Mr.Jayakathan,	4	5	5	5	4	5	Shared a lot. Good session.
23-04-2021 12:07	Mrs.RenugaDevi,	4	5	4	4	5	3	good
23-04-2021 12:07	Mr. Mohammed Haris,AP/CSE	5	5	5	5	5	5	This session is very useful for learning the cloud computing and AWS services
23-04-2021 12:08	Mrs.D. Shyamala Devi,AP/IT	4	5	4	5	4	4	Very useful
23-04-2021 12:08	Mrs.Helenchandra,A P/CS	5	4	5	4	4	5	Very useful for session
23-04-2021 12:08	Ms.Suganya,AP/CS	5	5	5	5	5	5	Really very useful for us.

ATTESTED

Dr. S. RAMABALAN, M.E., Ph.D.,
PRINCIPAL

E.G.S. Pillay Engineering College,

Thethi, Nagore - 611 002.

Nagapattinam (Dt) Tamil Nadu.

23-04-2021 12:08	Mrs.Meerabai,AP/C S	5	5	5	5	5	5	Very useful session and we'll knowledgeable person to take the session thank you Guna bro. thank you for the webinar mam.
23-04-2021 12:09	Mr. Mohammed Haris	4	4	4	4	4	4	Excellent
23-04-2021 12:09	Mrs.D. Shyamala Devi	5	4	4	4	5	4	Nice to participate this webinar
23-04-2021 12:09	Mrs.Helenchandra	5	5	5	5	5	5	Very helpful session thank you sir
23-04-2021 12:10	Ms.Suganya	5	5	5	5	5	5	Good.its very usefull
23-04-2021 12:10	Mrs.Meerabai	5	5	5	5	5	5	Very useful to this optturnity in the class listen for job and more this section was very useful to some ideas Thank you...
23-04-2021 12:18	Dr.V.Ramanathan	5	5	4	4	5	4	Thank you so much for ur wonderful session. It's very useful for us.
23-04-2021 12:19	Mr. R. Chozha Prabhu	5	5	4	5	5	4	Super
23-04-2021 12:22	Mrs. P. Ramyadevi	5	5	5	5	5	5	Good.

ATTESTED

Dr. S. RAMABALAN, M.E., Ph.D.,
PRINCIPAL

E.G.S. Pillay Engineering College,
Thethi, Nagore - 611 002,
Nagapattinam (Dt) Tamil Nadu.

23-04-2021 12:26	Ms.N.Saranya	5	5	5	5	5	5	Very useful
23-04-2021 12:29	Mr.R.Raja	5	5	5	5	5	5	Very useful
23-04-2021 12:31	Dr.V.Ramanathan	4	4	5	4	4	4	Very useful

ATTESTED

Dr. S. RAMABALAN, M.E., Ph.D.,
PRINCIPAL
E.G.S. Pillay Engineering College,
Thethi, Nagore - 611 002.
Nagapattinam (Dt) Tamil Nadu,

E.G.S.PILLAY ENGINEERING COLLEGE,[AUTONOMOUS]NAGAPATTINAM – 611002
Approved by AICTE,New Delhi | Affiliated to Anna University,Chennai
Accredited by NAAC with 'A' Grade | An ISO 9001:2015 Certified Institution
Nagapattinam – 611001 Tamil Nadu India
Ph: 04365 -251112 / 251114 | E-mail:enquiries@egspec.org | Website : WWW.egspec.org

ONLINE WEBINAR IN AWS
On
23.04.2021
Sample Screen shots



ATTESTED

Dr. S. RAMABALAN, M.E., Ph.D.,
PRINCIPAL
E.G.S. Pillay Engineering College,
Thethi, Nagore - 611 002.
Nagapattinam (Dt) Tamil Nadu.

**E.G.S.PILLAY ENGINEERING COLLEGE,[AUTONOMOUS]NAGAPATTINAM –
611002**

**Approved by AICTE,New Delhi | Affiliated to Anna University,Chennai
Accredited by NAAC with 'A' Grade | An ISO 9001:2015 Certified Institution
Nagapattinam – 611001 Tamil Nadu India
Ph: 04365 -251112 / 251114 | E-mail:enquiries@egspec.org | Website : WWW.egspec.org**

ONLINE WEBINAR IN AWS

On

23.04.2021

Sample Screen shots

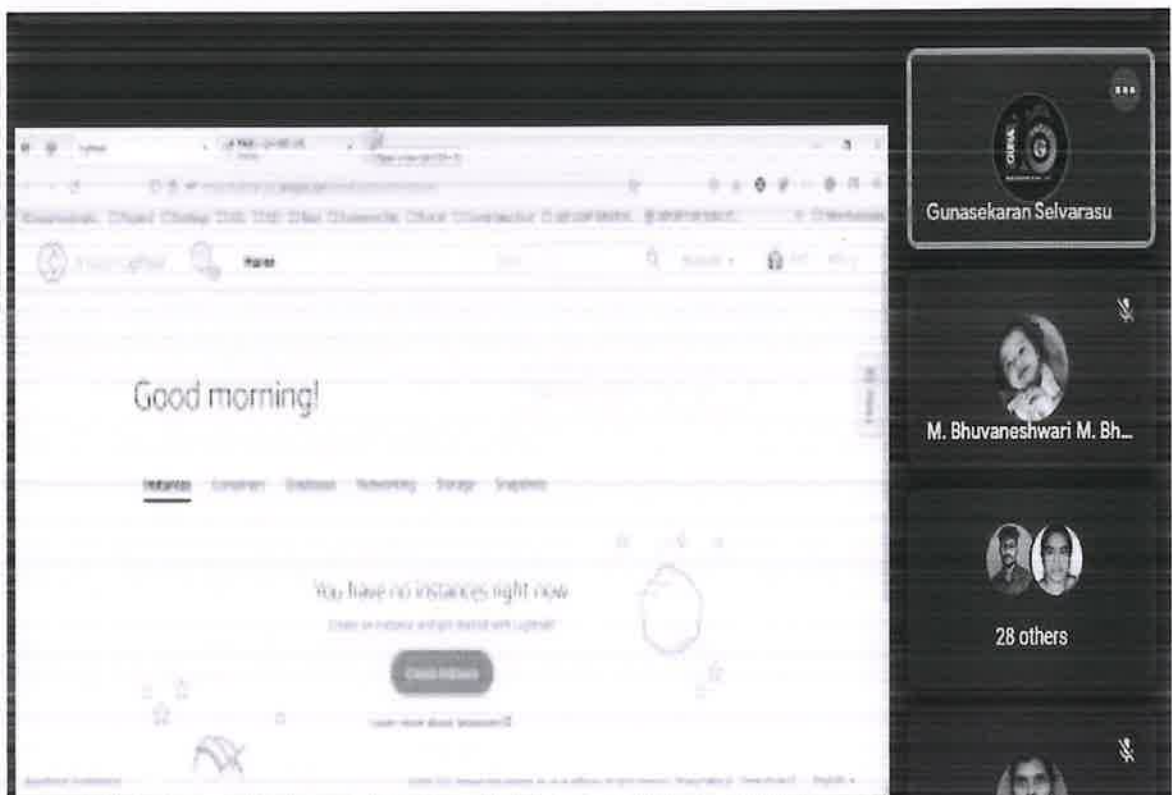

During the Workshop

**Dr. S. RAMABALAN, M.E., Ph.D.,
PRINCIPAL
E.G.S. Pillay Engineering College,
Thethi, Nagore - 611 002.
Nagapattinam (Dt) Tamil Nadu.**

E.G.S.PILLAY ENGINEERING COLLEGE,[AUTONOMOUS]NAGAPATTINAM – 611002

Approved by AICTE,New Delhi |Affiliated to Anna University,Chennai

Accredited by NAAC with 'A' Grade | An ISO 9001:2015 Certified Institution

Nagapattinam – 611001 Tamil Nadu India

Ph: 04365 -251112 / 251114 | E-mail:enquiries@egspec.org | Website : WWW.egspec.org

ONLINE WEBINAR IN AWS

On

23.04.2021

Sample Screen shots



Assessment

ATTESTED

**Dr. S. RAMABALAN, M.E., Ph.D.,
PRINCIPAL**

**E.G.S. Pillay Engineering College,
Thethi, Nagore - 611 002.
Nagapattinam (Dt) Tamil Nadu.**

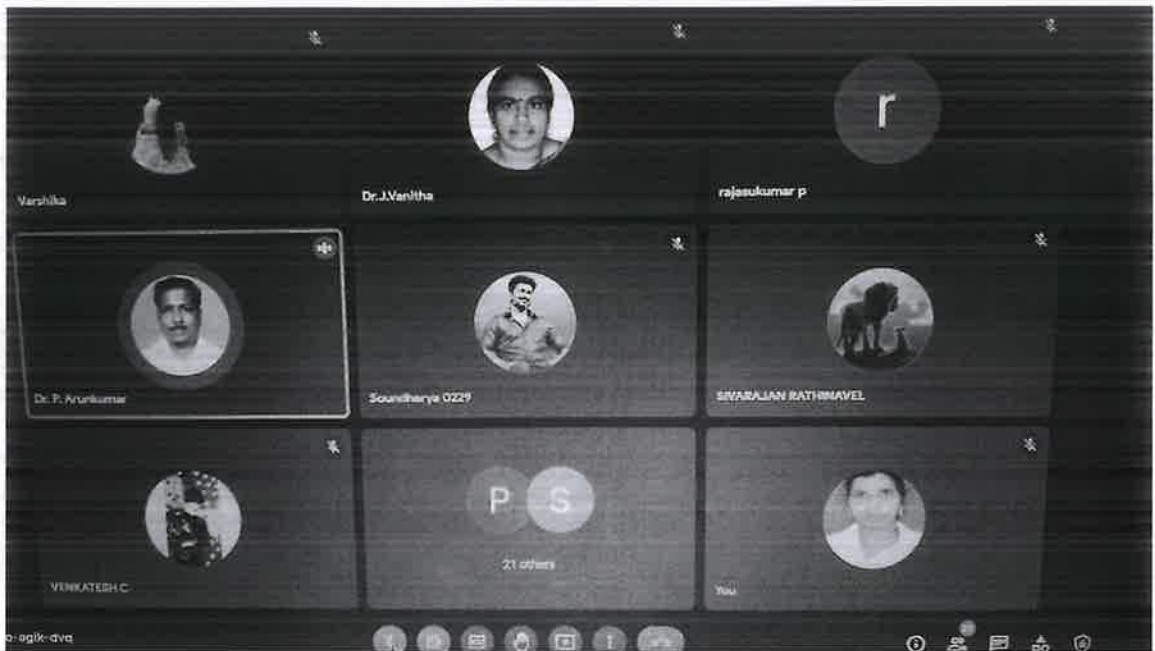

ATTESTED
[Signature]
Dr. S. RAMABALAN, M.E., Ph.D.,
PRINCIPAL
E.G.S. Pillay Engineering College,
Thethi, Nagore - 611 002.
Nagapattinam (Dt) Tamil Nadu.

E.G.S.PILLAY ENGINEERING COLLEGE,[AUTONOMOUS]NAGAPATTINAM – 611002

Approved by AICTE,New Delhi |Affiliated to Anna University,Chennai

Accredited by NAAC with 'A' Grade | An ISO 9001:2015 Certified Institution

Nagapattinam – 611001 Tamil Nadu India

Ph: 04365 -251112 / 251114 | E-mail:enquiries@egspec.org | Website : WWW.egspec.org

ONLINE WEBINAR On AWS

23.04.2021

Sample Certificate

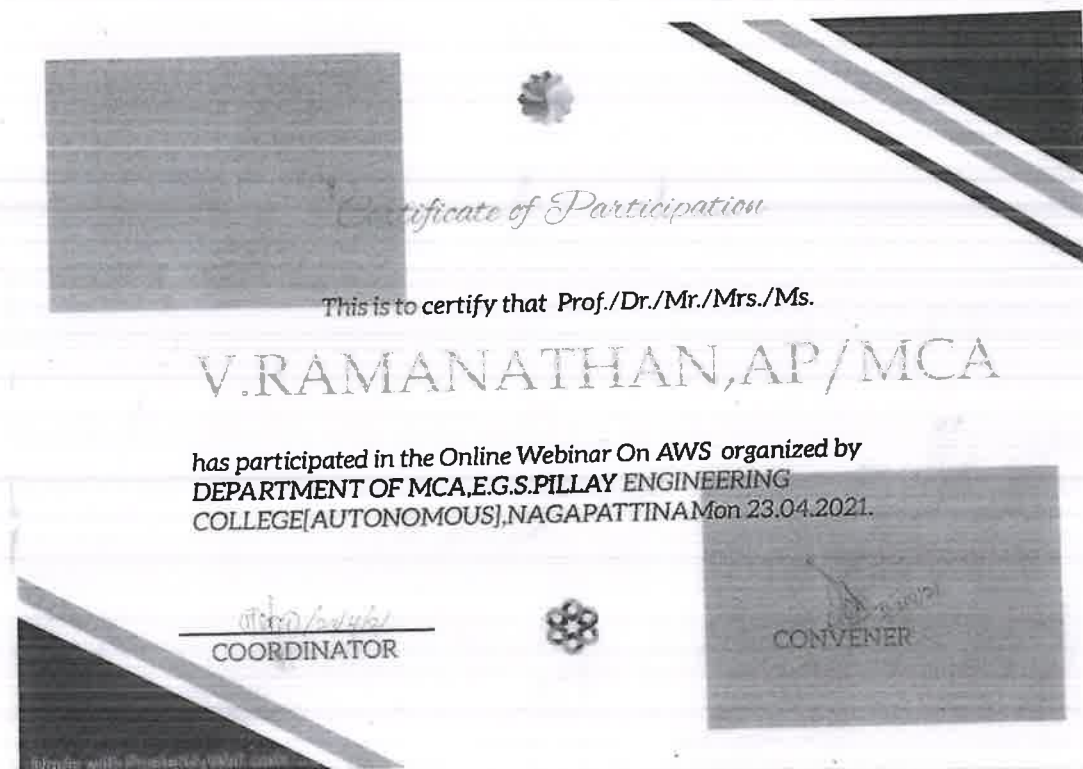

ATTESTED

[Signature]

**Dr. S. RAMABALAN, M.E., Ph.D.,
PRINCIPAL**

**E.G.S. Pillay Engineering College,
Thethi, Nagore - 611 002.
Nagapattinam (DI) Tamil Nadu**

**E.G.S. PILLAY ENGINEERING COLLEGE
(AUTONOMOUS)**

Old Nagore Road, Thethi, Nagore Village, Nagapattinam – 611002

DEPARTMENT OF MECHANICAL ENGINEERING



Report

Two Days Hands on Training

on

Welding Techniques

13.02.2020-14.12.2020

E.G.S. PILLAY ENGINEERING COLLEGE, Nagapattinam

DEPARTMENT OF MECHANICAL ENGINEERING

Non-Teaching Training Program

Title: Training Program on Welding Techniques

S. No.	Content
1.	Report
2.	Approval letter from Principal
3.	Proposed Budget
4.	Circular
5.	Schedule
6.	Attendance
7.	Course material
8.	Photos
9.	Feedback from participants
10.	Certificates



E.G.S. PILLAY ENGINEERING COLLEGE, NAGAPATTINAM
(Autonomous)
Accredited by NAAC with 'A' Grade
Department of Mechanical Engineering
(Accredited by NBA)

A REPORT ON TWO DAY TRAINING PROGRAM
ON
WELDING EQUIPMENTS

The department of Mechanical Engineering, E.G.S. Pillay Engineering College, Nagapattinam organized a training program for non-teaching faculty members of E.G.S. Pillay group of institutions on 13.12.2020 and 14.02.2020. The program was entitled as "Hands on Training on Welding Equipments". The coordinator for this program was Dr. N. Ramanujam, Professor, Department of Mechanical Engineering.

The session was inaugurated by the Hon'ble secretary of the Institution Shri.S.Pamesvaran, and the E. G. S. Pillay trust member Mr. S. Sankarganesh, Principal Dr. S. Ramabalan and Controller of Examination Dr. M. Chinnadurai. The Prof.G. Sundaravadivel welcomed the gathering and followed by inaugural speech by Dr. G. Gurumoorthi, HOD/MECH.

The training session was handled by the internal expert member Dr. N. Ramanujam, Professor/MECH. Initially, a lecture session was given on the basics of welding techniques, various welding types and the equipments that are used in those welding types. The lecture enabled the participants to understand about the welding and its equipments. Then, a hands-on training session was given to those participants on the handling of manual metal arc welding by wearing all safety apparels and following all safety procedures.

Finally, certificates were distributed to all the participants and vote of thanks was given by Prof. G. Sundaravadivel of the department of mechanical.

PROGRAM COORDINATOR

ATTESTED

Dr. S. RAMABALAN, M.E., Ph.D.,
PRINCIPAL
E.G.S. Pillay Engineering College,
Thethi, Nagore - 611 002.
Nagapattinam (Dt) Tamil Nadu.

HOD/MECH

From

Dr.G.Gurumoorthi
Head of the department
Department of Mechanical Engineering
E.G.S.Pillay Engineering College
Nagapattinam

To

The principal
E.G.S.Pillay Engineering College
Nagapattinam.

4/12/20

Sub: Request for permission to conduct training program for non-teaching staff-reg

Respected Sir,

As per the instruction from management, the department of Mechanical Engineering has planned to conduct a training program on welding techniques for the non-teaching staff of civil, electrical and electronics and Mechanical Engineering. So in this context I kindly request to avail permission to pursue the program in the month of December 2020.

Thanking you

Date: 04.12.2020

Place: Nagapattinam.

ATTESTED

Dr. S. RAMABALAN, M.E., Ph.D.,
PRINCIPAL
E.G.S. Pillay Engineering College,
Thethi, Nagore - 611 002.
Nagapattinam (Dt) Tamil Nadu.

Yours truly

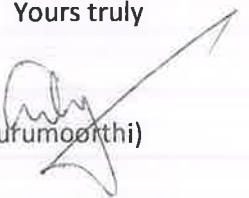
(Dr.G.Gurumoorthi)

E.G.S. PILLAY ENGINEERING COLLEGE, Nagapattinam

DEPARTMENT OF MECHANICAL ENGINEERING

Title: Training Program on Welding Techniques

Date: 13.12.2020&14.02.2020

PROPOSED BUDGET

S. No.	ITEMS DESCRIPTION	QUANTITY REQUIRED	AMOUNT / QUANTITY (Rs.)	ESTIMATED AMOUNT (Rs.)
1.	Tea & Snacks	15*(4 sessions)	18	1080
2.	Flex	1	350	350
3.	Report preparation	1	250	250
4.	Certificate	11	40	500
5.	Food for Participants & Organizers	15*(2 sessions)	80	2400
Total Amount				4580

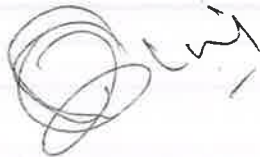

Program Coordinator

ATTESTED

Dr. S. RAMABALAN, M.E., Ph.D.,
PRINCIPAL
E.G.S. Pillay Engineering College,
Thethi, Nagore - 611 002.
Nagapattinam (Dt) Tamil Nadu.

HoD/Mech

**E.G.S.Pillay Engineering College,
Nagapattinam.
Department of Mechanical Engineering**

Circular

Date: 06.12.2020

It is hereby informed to the non-teaching staffs of the department of Mechanical, Civil and Electrical and electronics engineering, the department of Mechanical Engineering It is hereby planned to conduct a hands-on training on welding techniques for two days from 13.12.2020 – 14.02.2020. All the non-teaching staffs of the above said department are instructed to attend the program without fail.

ATTESTED



**Dr. S. RAMABALAN, M.E., Ph.D.,
PRINCIPAL
E.G.S. Pillay Engineering College,
Thethi, Nagore - 611 002.
Nagapattinam (Dt) Tamil Nadu.**



HOD/Mech

Copy to:

The Secretary, The Joint Secretary The Principal, All HODs, Office file, Department file

E.G.S. PILLAY ENGINEERING COLLEGE, NAGAPATTINAM

DEPARTMENT OF MECHANICAL ENGINEERING

Non-Teaching Training Program

Title: Hands on Training on Welding Equipments

Date: 13/12/2020 and 14/02/2020

1. PROGRAM SCHEDULE:

S.NO	DATE	SESSION	COURSE DESCRIPTION	BENEFICIARIES
1	13.02.2020	FN	Introduction to different welding techniques	Non-teaching staffs of department of Mechanical, Civil and EEE
		AN	Friction-stir welding and laser beam welding	
2	14.02.2020	FN	Hands on training on different welding techniques	
		AN	Hands on session on different welding techniques	

2. PARTICIPANTS DETAILS:

PARTICIPANTS DETAILS	MAXIMUM NUMBER OF PARTICIPANTS
All Technical Assistant/Supporting staff	20

3. RESOURCE PERSONS:

RESOURCE PERSON	CONVENER	PROGRAM COORDINATOR
Dr. N. Ramanujam, Professor/MECH	Dr. G. Gurumoorthi, Professor and HOD/MECH	Dr. N. Ramanujam Professor/MECH

Program coordinator

ATTESTED

Dr. S. RAMABALAN, M.E., Ph.D.,
PRINCIPAL
E.G.S. Pillay Engineering College,
Thethi, Nagore - 611 002.
Nagapattinam (Dt) Tamil Nadu.

HOD

E.G.S.PILLAY ENGINEERING COLLEGE, NAGAPATTINAM

DEPARTMENT OF MECHANICAL ENGINEERING

TRAINING PROGRAM FOR NON-TEACHING STAFF

ATTENDANCE

S.NO	STAFF NAME	DEPARTMEN T	13.12.202 0		14.12.2020	
			FN	AN	FN	AN
1	Mr.S.Sakthivel	MECHANICAL	✓	✓	✓	✓
2	Mr.S.Venkatesan	MECHANICAL	SV	SV	SV	a
3	Mr.K.Rajasekaran	MECHANICAL	Ka	a	Ka	Ka
4	Mr.S.Ramamoorthy	CIVIL	ha	ha	ha	a
5	Mr.G.Chellappa	MECHANICAL	cb	cb	cb	a
6	Mr.V.Ramu	MECHANICAL	va	va	va	va
7	Mr.K.Balamurugan	MECHANICAL	Bm	Bm	Bm	Bm
8	Mr.S.Joseph	MECHANICAL	JS	JS	JS	JS
9	Mr.R.Vignesh	EEE	VJ	VJ	VJ	VJ
10	Mr.M.Nagarajan	EEE	MN	MN	MN	MN
11	Mr.P.Rajkumar	CIVIL	PS	PS	PS	PS

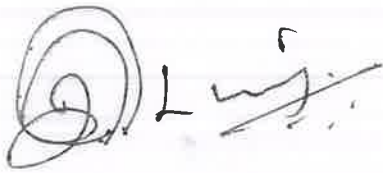

ATTESTED

Dr. S. RAMABALAN, M.E., Ph.D.,
PRINCIPAL

E.G.S. Pillay Engineering College,
Thethi, Nagore - 611 002.
Nagapattinam (Dt) Tamil Nadu.



WELDING

1. INTRODUCTION

Welding is a process by which metals are joined by heating them to a suitable temperature with or without the application of pressure and addition of filler materials. Welding processes are employed in most of the modern fabrication works and industries.

2. CLASSIFICATION OF WELDING PROCESSES

Welding processes are broadly classified under two main headings: -

- i) Pressure welding or Plastic welding processes
- ii) Non-Pressure welding or Fusion welding processes

i) Pressure welding or Plastic welding: - In this process, the ends of metal pieces to be joined are heated to plastic state and are joined together by applying pressure on them. No additional filler material is used.

eg: Blacksmith welding, Resistance welding, Cold pressure welding etc.

ii) Non-Pressure welding or Fusion welding: - here the material at the joint is heated to molten state (fusion state) and allowed to solidify. Thus, the two parts are joined together without the application of any pressure. It uses a filler material such as an electrode.

eg: Gas welding, Arc welding, Thermit welding etc.

3. ARC WELDING

Arc welding is a fusion welding process in which welding is done by producing heat from an electric arc between the work and electrode. Both D.C. and A.C. electric supply are used for this. The arc between the two terminals produces heat to melt the metal. If two pieces of metal that are to be joined are placed so that they touch or almost touch one another and the arc from the electrode is directed at this junction, the heat generated by the arc (approx. 3500°C) causes a small section of the edges of both pieces to melt. These molten portions along with the molten portions of the electrode flow together. As the arc column is moved, the molten puddle solidifies joining the two pieces of metal with a combination of electrode and base metal.

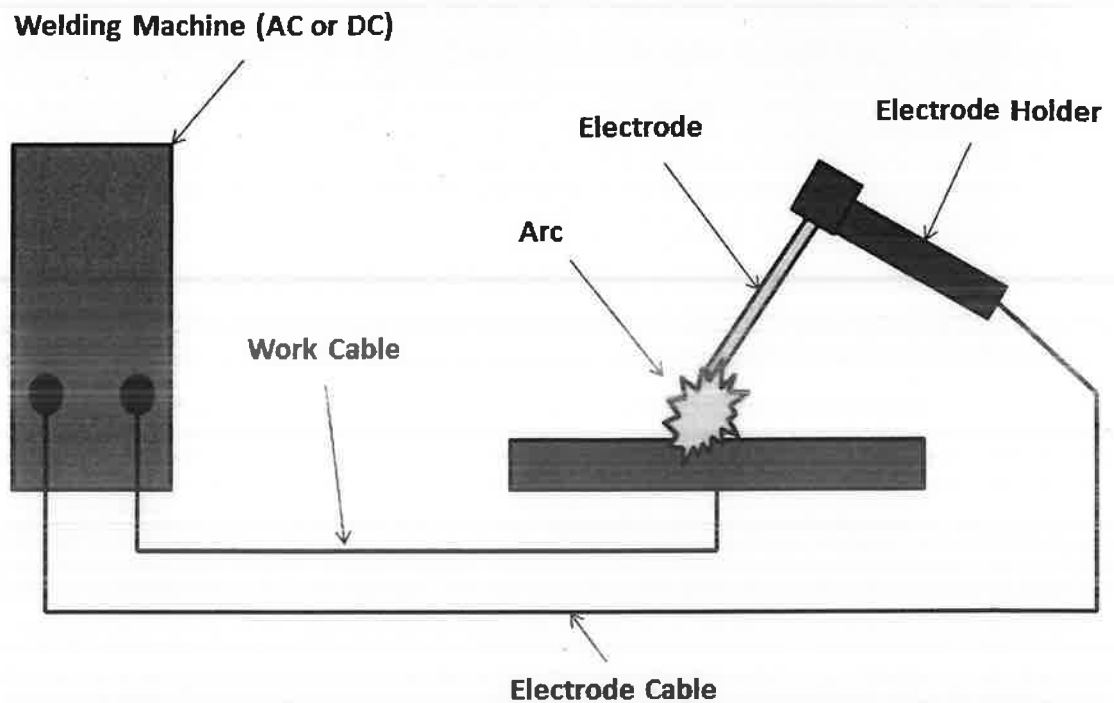

Basic Arc Welding Circuit Diagram

There are different methods of arc welding in practice as listed below:

- i) Metal Arc Welding
- ii) Carbon Arc Welding
- iii) Atomic Hydrogen Arc Welding
- iv) Tungsten inert gas Arc Welding (TIG)
- v) Metal inert gas Arc Welding (MIG)
- vi) Submerged Arc Welding
- vii) Plasma Arc Welding

3.1 Metal Arc Welding

The commonly used arc welding method is metal arc welding. In this process a metalelectrode is used. The metal electrode itself melts and acts as a filler material.

An arc welding circuit consists of the following essential items:

- a) The power source ie the Welding machine
- b) Welding lead cable and electrode holder
- c) Welding return cable and clamp

d) Welding earth

3.2 Arc Welding Machines

There are three types of welding machines in use:

- i) Welding transformer
- ii) Welding generator
- iii) Welding rectifier

i) Welding transformer

It is used to change the voltage and current to the desired range suitable for welding. Normally low voltage high current (high amperage) supply is preferred for welding. The welding transformer operates on A.C. supply only and it has no rotating parts. It is a step-down transformer which reduces the main supply voltage (220 or 440 V) to the welding supply open circuit voltage between 40 and 100 V.

ii) Welding generator

It is used to generate D.C supply for arc welding. It may be driven by an A.C. motor or driven by a petrol or diesel engine. It can be used anywhere in the field work, away from the electric lines.

iii) Welding rectifier

It is used to convert A.C. into D.C welding supply and does not have any rotating parts. It is basically a transformer, but the output of which is connected with a rectifier to change the A.C. into D.C.

3.3 Welding Electrode

Electrode is a conductor from which an arc struck. The arc melts electrode and parent metal. They join together to form a good weld when solidifies. The electrode is a core, coated with a solid flux act as a filler material and is consumed during welding by keeping a constant arc length. The flux when melts produce a slag which floats on the metal pool, protects the weld from oxidation. The flux of electrode mainly contains cellulose (burns and produces a gaseous shield around the arc), calcium carbonate and calcium fluoride (impart fluidity to the slag), Iron powder (for higher penetration and deposition), Titania (for stabilizing the arc), asbestos etc.

Electrodes are available in different standard lengths of 450, 350, 300 and 200 mm. A core length of 25mm from one end is left uncoated for holding in the electrode holder. It is

mainly specified by its core diameter.

Electrode size in mm	Gauge No. (SWG)	Current range in ampere (A)
1.6	16	40-60
2.5	12	50-80
3.2	10	90-130
4.0	8	120-170
5.0	6	130-270
6.0	4	300-400

4. GAS WELDING

Oxy-fuel welding, commonly referred to as oxy welding or gas welding is a process of joining metals by application of heat created by gas flame. The fuel gas commonly acetylene, when mixed with proper proportion of oxygen in a mixing chamber of welding torch, produces a very hot flame of about 3150 - 3300 °C .

Different gases suitable for welding and cutting are Acetylene, hydrogen, LPG, Methane etc.

4.1 Oxy- Acetylene Gas Welding

The oxy-acetylene welding process uses a combination of oxygen and acetylene gas to provide a high temperature flame. The high temperature flame melts the metal faces of the work- pieces to be joined, causing them to flow together. A filler metal alloy is normally added and sometimes used to prevent oxidation and to facilitate the metal union.

OXY-ACETYLENE GAS WELDING APPARATUS

Oxy-fuel apparatus consists of two cylinders (one oxygen and one acetylene) equipped with two regulators, pressure gauges, two lengths of hose, and a blow torch. The regulators are attached to cylinders and are used to reduce and maintain a uniform pressure of gases at the torch. The gases at reduced pressure are conveyed to the torch by the hoses. The regulators include high pressure and low-pressure gauges to indicate the contents of the cylinder and the working-pressure on each hose. When the gases reach the torch, they

are there mixed and combustion takes place at the welding tip fitted to the torch.

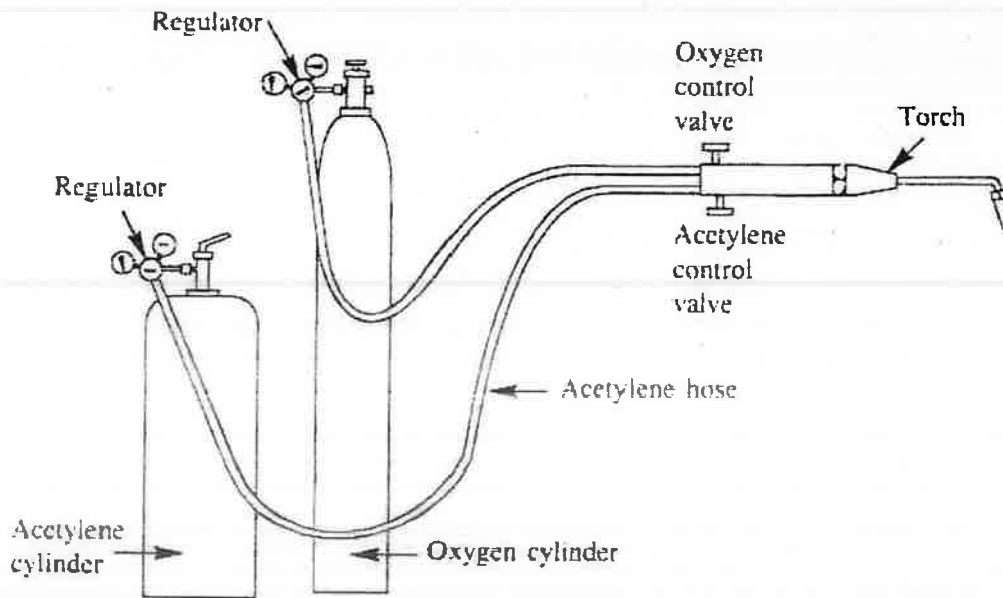

The basic equipment's used to carry out gas welding are:

1. Oxygen gas cylinder (coloured in black) with valve made of brass having right hand threads
2. Acetylene gas cylinder (coloured in maroon/red) with valve having left hand threads
3. Oxygen pressure regulator
4. Acetylene pressure regulator
5. Oxygen gas hose (Black)
6. Acetylene gas hose (Red/maroon)
7. Welding torch or blow pipe with a set of nozzles and gas lighter
8. Trolleys for the transportation of oxygen and acetylene cylinders
9. Set of keys and spanners
10. Filler rods and fluxes
11. Protective clothing for the welder (e.g., asbestos apron, gloves, goggles, etc.)

WELDING TORCH (BLOW PIPE)

A welding torch mixes oxygen and acetylene in the desired proportions, burns the mixture at the end of the tip, and provides a means for moving and directing the flame.

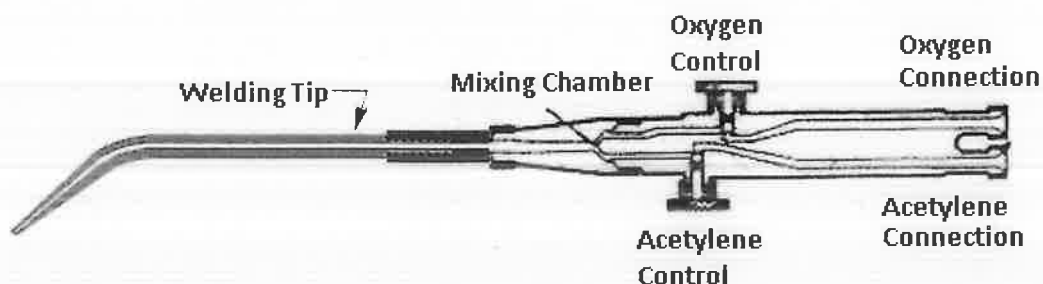

Fig: Welding Torch

There are two types of welding torches, namely:

- a) High pressure (or equal pressure) type
- b) Low pressure (or injector) type

High pressure blowpipes or torches are used with (dissolved) acetylene stored in cylinders at a pressure of 117 psi. Low pressure blowpipes are used with acetylene obtained from an acetylene generator at a pressure of 8 inch - head of water (approximately 0.3 psi).

To change the power of the welding torch, it is only necessary to change the nozzle tip (size) and increase or decrease the gas pressures appropriately.

4.2 Types of Gas Welding Flames

In oxyacetylene welding, flame is the most important tool. All the welding equipment simply serves to maintain and control the flame. The flame must be of the proper size, shape and condition in order to operate with maximum efficiency. Three distinct types of flames are possible on adjusting the proportions of acetylene and oxygen:

- 1. Neutral Flame (Acetylene oxygen in equal proportions)
- 2. Oxidizing Flame (Excess of oxygen)
- 3. Reducing Flame (Excess of acetylene)

(a) Neutral flame

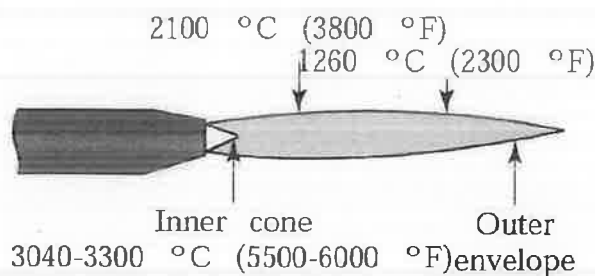

(b) Oxidizing flame

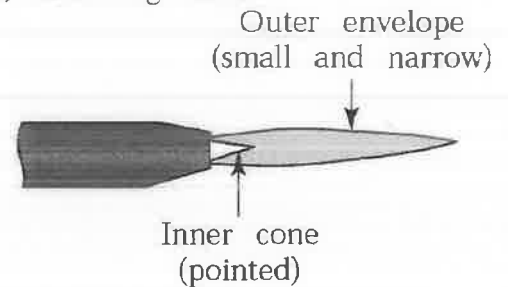

(c) Carburizing (reducing) flame

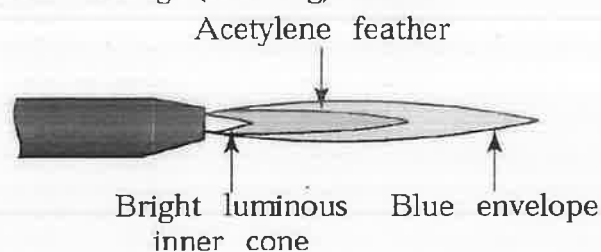

**Fig: Types of Welding
Flames**

5. TOOLS AND ACCESSORIES USED IN WELDING SHOP

i) Flat file

A file is a hardened piece of high-grade steel with slanting rows of teeth and is used for removing excess material to smooth or fit metal parts. Files are generally forged out of high carbon steel or tungsten steel followed by cutting of teeth, hardening and tempering.

iii) Hack saw

The hack saw is used to cut metals of different sections. The main parts are frame, handle and a replaceable blade. The blades are available in standard lengths 225, 250 and 300mm.

iv) Try square

Try square is mainly used for checking the squareness of surfaces or edges which are adjacent, flatness of a filed surface and for marking out lines on workpieces. It consists of a blade and stock which are made of steel fixed rigidly at 90° to each other.

v) Steel rule/ Brass rule

The steel rule consists of a hardened steel strip having line graduations etched or engraved in it. They are usually 150mm or 300mm long and is used to take linear measurements to an accuracy of 1mm or 0.5mm. The brass rule is similar to steel rule, but it is made of brass. Since the brass possess low coefficient of linear expansion, its dimensional accuracy will be more reliable in heated regions.

vi) Ball peen hammer

Hammer is a hand tool made of tool steel, largely used for striking on the metals. A hammer is named by its peen. The ball shaped peen hammer is known as ball peen hammer. The peen and face are hardened.

vii) Punches

Punches are percussion tools and are manufactured from tool steel. They are used on any scribed lines by indentations. Tips are tapered, hardened and tempered. The shanks are knurled for easier handling and gripping. The punch whose tip is tapered at an angle of 90°

is known as centre punch used to mark centers to be drilled or to mark Centre of an edge. A dot punch with tip tapered at 60° is used to punch a chain of dots on a scribed line.

viii) Chipping hammer

It is a welding tool used to remove slag from the weldment

ix) Electrode holder

It is used to hold the electrode properly. Its mouth grips the electrode and passes current to the electrode through the welding cable connected at the other end of the holder. It should be well insulated.

x) Tongs

They are used to handle the hot metal (welding job) for positioning or while cleaning.

xi) Wire brush

It is used for cleaning the surface of the metal as well as for the slag from the welds. The wire brush is made of steel wires fitted on a wooden piece.

xii) Apron

It protects the welder's body and clothes from heat and sparks. Usually, leather apron is employed.

xiii) Face shield / eye shield (Welding screen)

It is used to prevent direct rays of arc, weld spatter and slag and protects the operator's eyes and face. It consists of a cover slag and a dark filter glass. The filter glass absorbs the ultra violet rays radiated by the arc.

xiv) Hand gloves

Mainly leather gloves are used to protect arm from welding spark and heat.

xv) Earth clamp

It is used to connect the return lead firmly to the work piece or to the welding table.

6. POSITIONS OF WELDING

All welding can be classified according to the position of the workpiece or the position of the welded joint on the plates or sections being welded.

There are four basic welding positions, which are illustrated in figure below

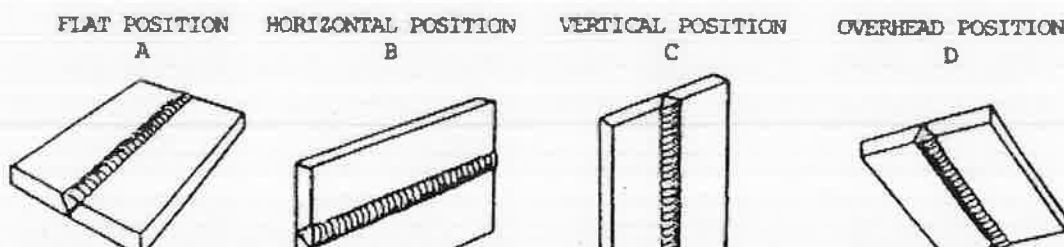

Fig: Positions of welding

MIG Welding

The minimum equipment needed for a typical GMAW setup includes a MIG welding machine, a power source, a shielding gas cylinder, consumable MIG wire, a welding gun, and a ground clamp.

It is also recommended to have basic safety equipment such as a welding helmet to protect your eyes and welding gloves to protect your hands from hot weld spatter.

MIG Welding Setup

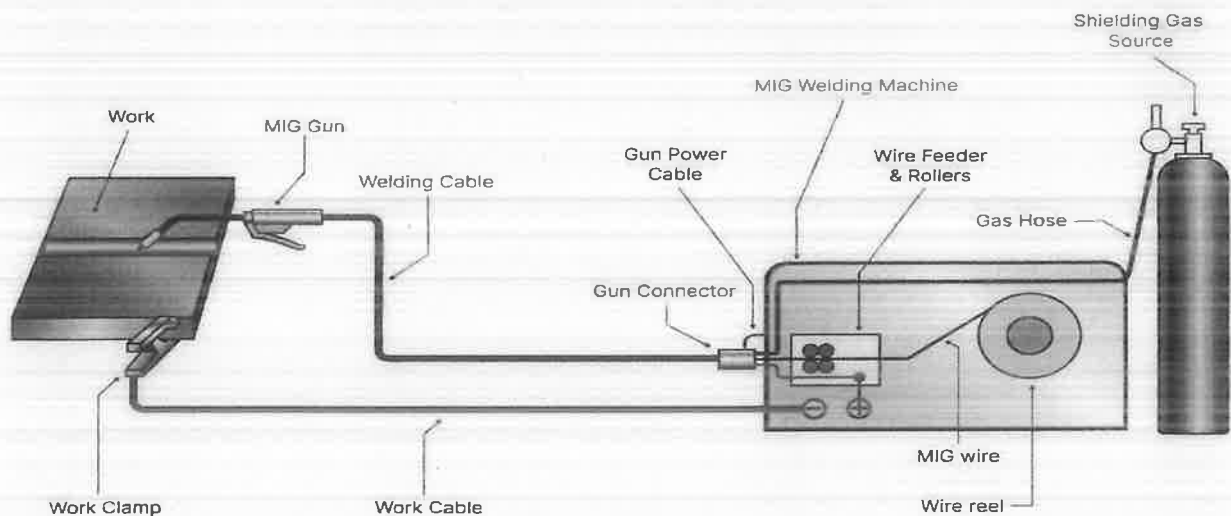

Diagram by weldguru.com

The Shielding Gas

While the shielding gas protects the weld pool from atmospheric contamination, it's imperative to understand how different shielding gasses affect the resulting weld.

There are two classifications for shielding gasses:

- **Active gasses** like carbon dioxide (" CO_2 ") and oxygen (" O_2 ")

- **Inert gasses** like argon ("Ar") and helium ("He")

Technically, MIG welding requires the use of inert gas only. That's why the process is called "metal *inert* gas" welding.

If the shielding gas mixture contains active gasses, the welding process is named "metal *active* gas" welding, or MAG for short. But most people call both approaches MIG welding because there isn't an apparent difference.

Active gasses influence the weld pool, spatter amount, and penetration depth. Inert gasses don't interact with the welded metal. However, inert gasses also modify the welding characteristics to an extent. For example, helium is inert, but it improves heat input and penetration.

MIG welding carbon steel usually requires a mix of 75% argon and 25% CO₂. It's also possible to MIG weld mild steel with 100% CO₂ to achieve better penetration. But welding aluminum requires a 100% argon or an Ar/He mixture.

TIG Welding

TIG, or tungsten inert gas, uses a non-consumable tungsten electrode to create an arc and join metal. It requires the use of shielding gas, most commonly pure argon or argon mixed with helium.

This welding process uses direct current ("DC") and alternating current ("AC") depending on the metal to be joined.

TIG Welding

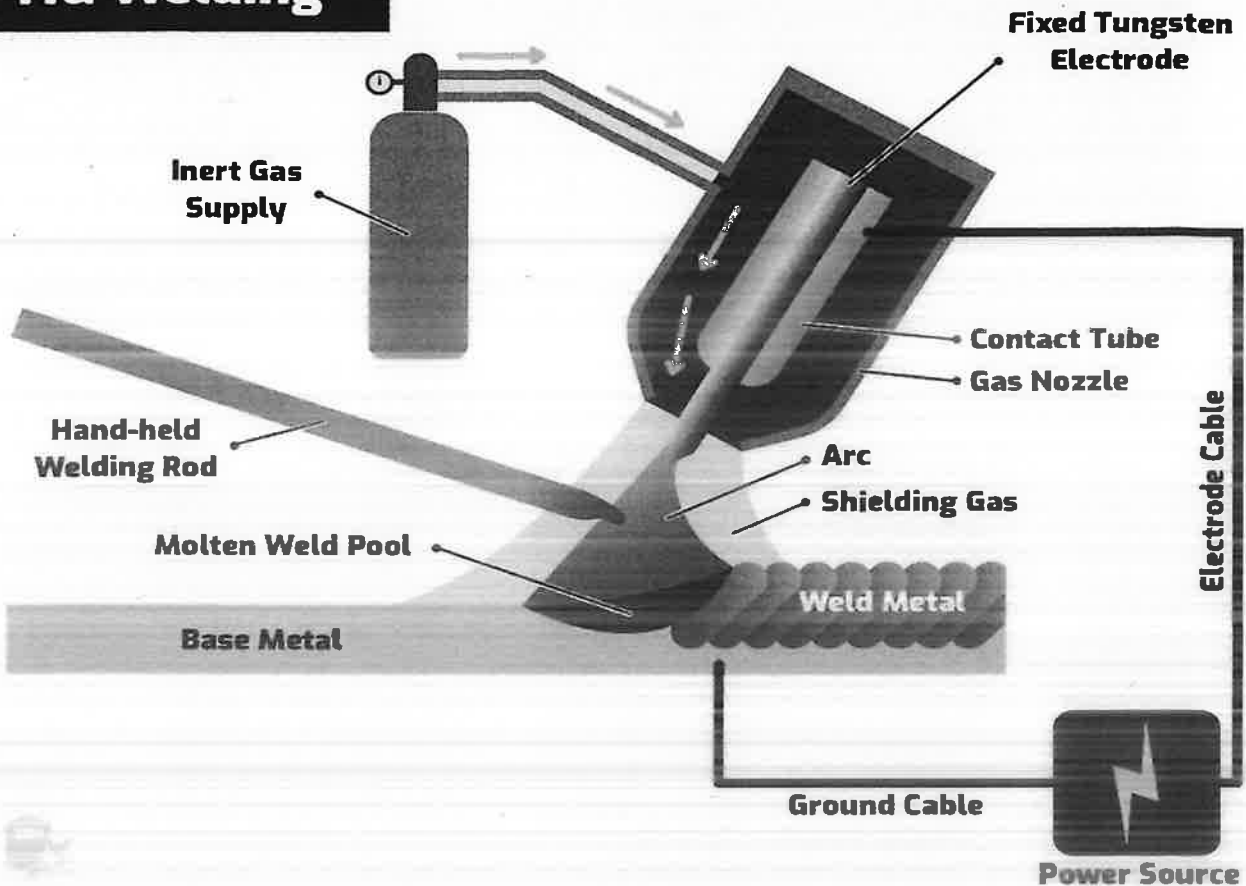

The American Welding Society ("AWS") classifies TIG welding as "gas tungsten arc welding," but the abbreviation "GTAW" is commonly used. Initially, the process was named "heliarc," but that term pops up rarely nowadays. You can read more about heliarc welding [here](#).

The unique aspects of TIG welding are the absence of physical contact between the electrode and the metal pieces and that the electrode is not consumed in the process. As a result, the arc is stable and clean and produces aesthetically pleasing welds.

Electrodes used in other arc welding processes physically interact with the metal and may involve various fluxing agents, which results in spatter and less control over the welding arc.

Reference:

1. **P.Kannaiah and K.L.Narayana** *Workshop Manual*. Scitech Publications, 1996
2. **D. Venugopal** *Basic Engineering Workshops: Pheory and Practice*. Arathy Publications, 2006
3. **G.Sukumaran** *Basic Engineering Workshops*. Link Books, 2003
4. **A. Bhatiya** *Fundamentals of Gas Cutting and Welding*. Course No: D06-002
Continuing Education and Development, Inc. 9 Greyridge Farm Court Stony Point, NY

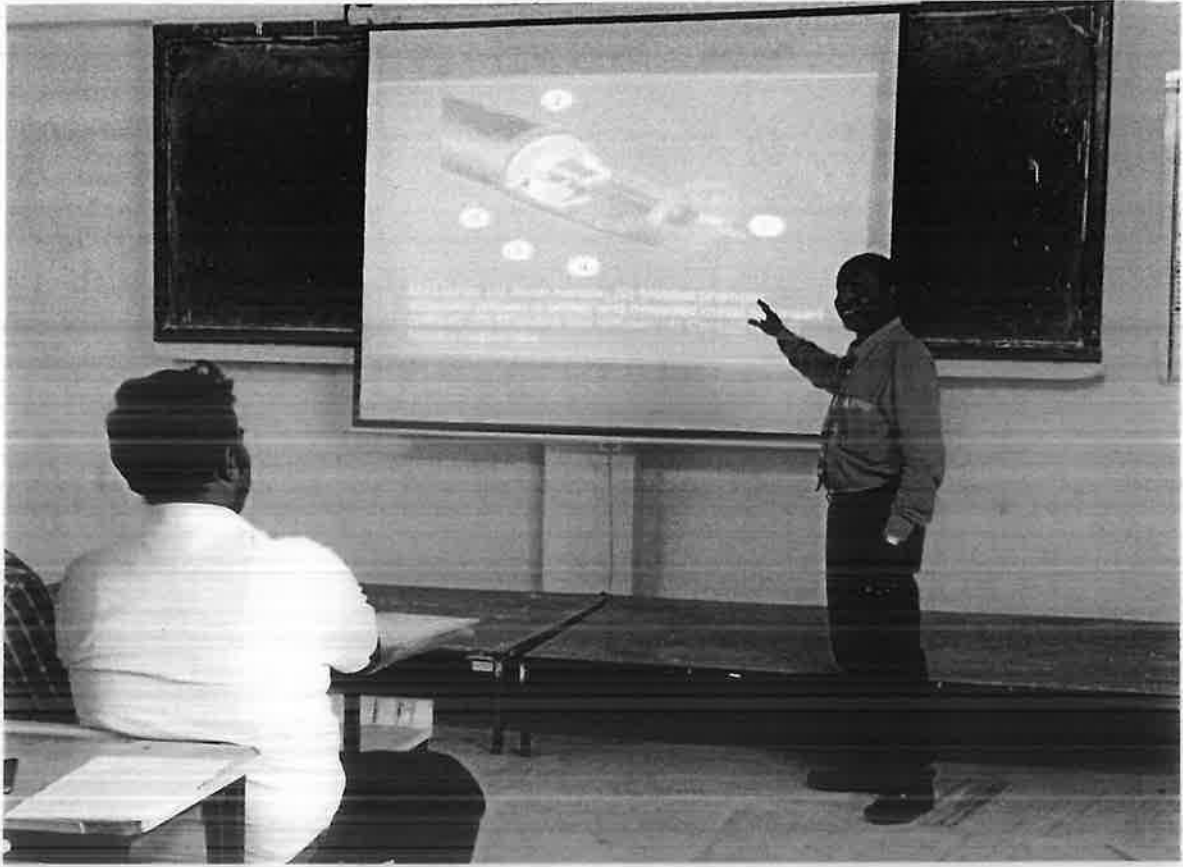

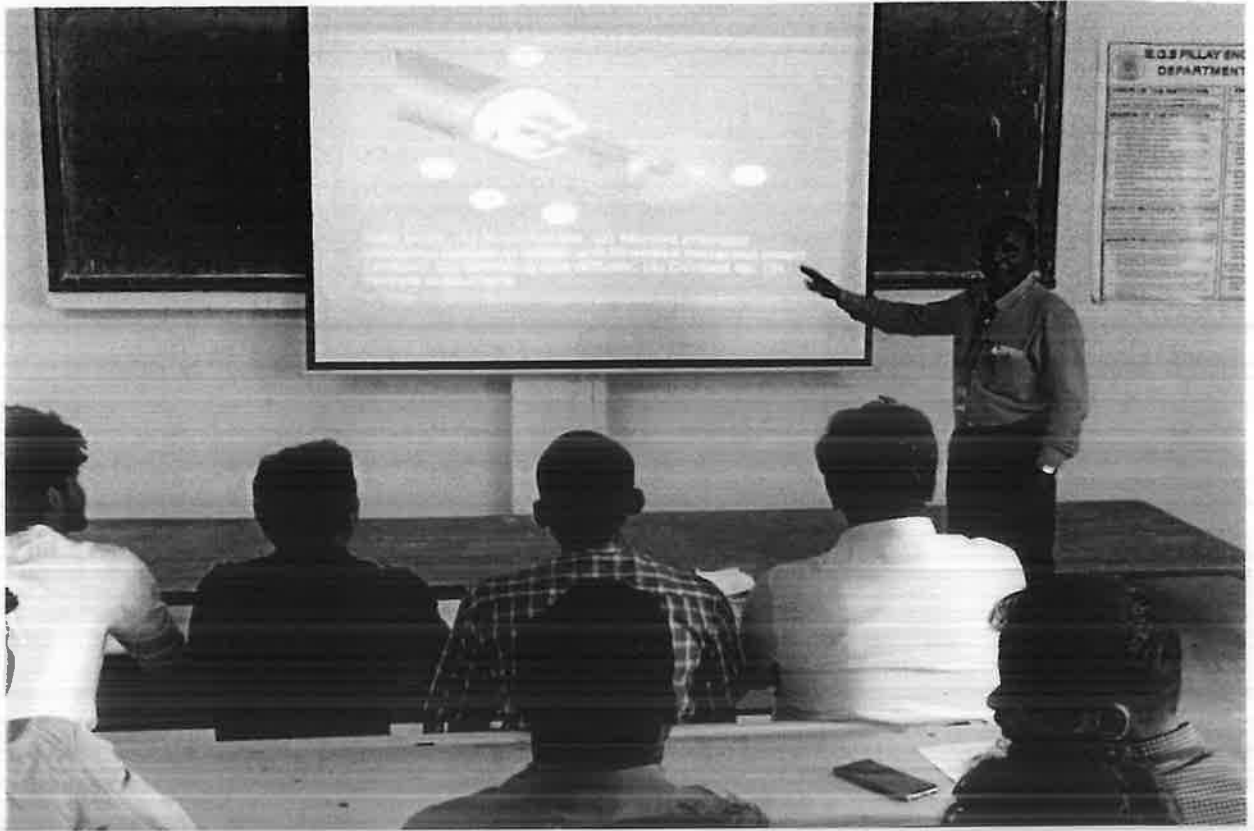

E.G.S.PILLAY ENGINEERING COLLEGE, NAGAPATTINAM
DEPARTMENT OF MECHANICAL ENGINEERING
HANDS-ON TRAINING ON WELDING TECHNIQUES
FEED BACK FORM

1. In the way trainers trained you : Excellent / ~~Good~~ / Average
2. Course contents : Excellent / ~~Good~~ / Average
3. In the way trainers cleared your doubts : Excellent / ~~Good~~ / Average
4. Impact of this program in your career : Excellent / ~~Good~~ / Average
5. Practical Sessions : Excellent / ~~Good~~ / Average
6. Suggestions if any

M. Nagesh Babu
Signature

[M. NAGESH BABU]

ATTESTED



Dr. S. RAMABALAN, M.E., Ph.D.,
PRINCIPAL

E.G.S. Pillay Engineering College,
Thethi, Nagore - 625 001
Nagapattinam (Dt) Tamil Nadu

FEED BACK FORM

- 1. In the way trainers trained you : Excellent / ~~Good~~ / Average
- 2. Course contents : Excellent / ~~Good~~ / Average
- 3. In the way trainers cleared your doubts : Excellent / ~~Good~~ / Average
- 4. Impact of this program in your career : Excellent / ~~Good~~ / Average
- 5. Practical Sessions : Excellent / ~~Good~~ / Average
- 6. Suggestions if any

b. Venkatesan
Signature
[S. VENKATASAN]

ATTESTED

[Signature]
Dr. S. RAMABALAN, M.E., Ph.D.,
PRINCIPAL
E.G.S. Pillay Engineering College,
Thethi, Nagore - 611 002.
Nagapattinam (Dt) Tamil Nadu.



EGS PILLAY

Engineering College

Autonomous

Old Nagore Road, Nagapattinam-611 002, Tamilnadu

Affiliated to Anna University | Approved by AICTE | Accredited by - NBA & NAAC 'A' Grade | Recognised by UGC 2(B) & 12(B) | An ISO 9001:2015 Certified Institution

Counselling Code : 3806

+91-4365-25111214 | principal@egspegc.org/enquires@egspegc.org

DEPARTMENT OF MECHANICAL ENGINEERING

Certificate of Participation

This is to certified that Mr./Ms. S. SAKTHIVEL has participated in "Hands-on Training on Welding Equipment's" organized by Department of Mechanical Engineering, EGSPEC during 13.12.2020 & 14.02.2020.

**Program
Co-ordinator**

Head of the Department

ATTESTED

Dr. S. RAMABALAN, M.E., Ph.D.,

PRINCIPAL

Principal

E.G.S. Pillay Engineering College,

Thethi, Nagore - 611 002.

Nagapattinam (Dt) Tamil Nadu.



EGS PILLAY

Engineering College

Autonomous

Old Nagore Road, Nagapattinam-611 002, Tamilnadu

Affiliated to Anna University | Approved by AICTE | Accredited by - NBA & NAAC 'A' Grade | Recognised by UGC 2(f) & 12(B) | An ISO 9001:2015 Certified Institution
Counselling Code : 3806 | +91-4365-25112/14 | principal@egspegpec.org/enquires@egspegpec.org

DEPARTMENT OF MECHANICAL ENGINEERING

Certificate of Participation

This is to certified that Mr./Ms. S. VENKATESAN has participated in "Hands-on Training on Welding Equipment's" organized by Department of Mechanical Engineering, EGSPEC during 13.12.2020 & 14.02.2020.

**Program
Co-ordinator**

ATTESTED

Dr. S. RAMABALAN, M.E., Ph.D.
PRINCIPAL

Head of the Department **Principal**

E.G.S. Pillay Engineering College,
Nagapattinam, Nagore - 611 002.
Nagapattinam (Dt) Tamil Nadu.