



## **E.G.S. PILLAY ENGINEERING COLLEGE**

(An Autonomous Institution, Affiliated to Anna University, Chennai)  
Nagore Post, Nagapattinam – 611 002, Tamilnadu.

## **DEPARTMENT OF CIVIL ENGINEERING**



**ATTESTED**

**Dr. S. RAMABALAN, M.E., Ph.D.,  
PRINCIPAL**

**E.G.S. Pillay Engineering College,  
Thethi, Nagore - 611 002.  
Nagapattinam (Dt) Tamil Nadu.**

## **Precious Enlightening Association of Civil Engineering (PEACE)**

Organized One-day Workshop on

**Guidelines For Writing a Research Paper**

**Date: 26/11/2018**

**Venue: Civil Seminar Hall**



**E.G.S. PILLAY ENGINEERING COLLEGE**  
(An Autonomous Institution, Affiliated to Anna University, Chennai)  
Nagore Post, Nagapattinam – 611 002, Tamilnadu.



**DEPARTMENT OF CIVIL ENGINEERING**

| SL.NO | CONTENTS                                    |
|-------|---|
| 1     | Vision, Mission, PEO, PSO AND PO Statements |
| 2     | Summary of the Event                        |
| 3     | Approval Letters & Circulars                |
| 4     | Invitation & Agenda                         |
| 5     | Participants Name List & Attendance         |
| 7     | Sample Photos                               |
| 8     | Feedback Forms                              |
| 9     | Certificate                                 |

ATTESTED

**Dr. S. RAMABALAN, M.E., Ph.D.,**  
**PRINCIPAL**  
E.G.S. Pillay Engineering College,  
Thethi, Nagore - 611 002.  
Nagapattinam (Dt) Tamil Nadu.



# E.G.S. PILLAY ENGINEERING COLLEGE

(An Autonomous Institution, Affiliated to Anna University, Chennai)  
Nagore Post, Nagapattinam – 611 002, Tamilnadu.



## DEPARTMENT OF CIVIL ENGINEERING

### DEPARTMENT VISION

To evolve as a Centre of excellence by imparting quality technical education and promote research to meet the emerging challenges in the field of Civil Engineering.

### DEPARTMENT MISSION

The Civil Engineering department is committed to

- M1:** Provide quality education through innovative teaching and learning practices.
- M2:** Encourage faculty and students to pursue higher education and carry out socially relevant innovative research thereby establishing centers of excellence in emerging areas of research.
- M3:** Offer consultancy services using state-of-the-art facilities fulfilling the needs of the industry and society.
- M4:** Enable our students and faculty to play leadership roles in a sustainable manner by adopting professional ethics, entrepreneurship activities, interpersonal skills and a lifelong learning attitude.

### PROGRAMME EDUCATIONAL OBJECTIVES (PEO's)

After successful completion of the programme, Graduates will be able to

- PEO1:** Become a successful Civil Engineer to meet the demand-driven needs in the field of Civil Engineering and related profession or pursue higher study and research or become an entrepreneur.
- PEO2:** Develop core competence by analyzing and design of Civil engineering systems with social awareness and responsibilities.
- PEO3:** Build professionalism, ethical approach, communication skills, and teamwork in their profession and adapt to modern trends by engaging in lifelong learning.

ATTESTED

  
**Dr. S. RAMABALAN, M.E., Ph.D.,  
PRINCIPAL**

**E.G.S. Pillay Engineering College,  
Thethi, Nagore - 611 002.  
Nagapattinam (Dt) Tamil Nadu.**

**PROGRAMME OUTCOMES (POs):**

After successful completion of the programme, Graduates will be able to

- PO1 Application knowledge of mathematics, science, engineering fundamentals
- PO2 Problem Analysis.
- PO3 Design and Development of Solutions
- PO4 Conduct investigations by designing experiments, analysis and interpretation of data and synthesis of information to provide valid conclusions
- PO5 Modern Tool Usage
- PO6 Assessing societal, health, safety, legal and cultural issues
- PO7 Examining Environmental impact and Sustainability
- PO8 Commitment to professional ethics.
- PO9 Function effectively as an individual, and as a member or leader in diverse teams and in multi-disciplinary settings
- PO10 Communicate effectively at oral, written, and presentation level
- PO11 Examine Project Management and Financial aspects
- PO12 Instil Life-long Learning

**PROGRAMME SPECIFIC OUTCOMES (PSOs):**

After successful completion of the programme, students will be able to

PSO1: Analyze the effects of natural calamities like Tsunami, storms, earthquakes, landslides etc. in design of stable structures.

PSO2: Use eco-friendly materials and mechanisms for sustainable and life-line infrastructures.

ATTESTED



Dr. S. RAMABALAN, M.E., Ph.D.,

PRINCIPAL

E.G.S. Pillay Engineering College,

Thethi, Nagore - 611 002.

Nagapattinam (Dt) Tamil Nadu.





# E.G.S. PILLAY ENGINEERING COLLEGE

(An Autonomous Institution, Affiliated to Anna University, Chennai)  
Nagore Post, Nagapattinam – 611 002, Tamilnadu.



## DEPARTMENT OF CIVIL ENGINEERING

### Organized One-day Workshop on Guidelines For Writing a Research Paper

#### REPORT

Organized One-day Workshop on “Guidelines For Writing a Research Paper” has been conducted for our faculties is organized by PEACE association, Department of Civil Engineering, E.G.S. Pillay Engineering College, Nagapattinam. The program was conducted on 26/11/2018. Our senior faculty Dr.R.Elliss Yogesh, Assoc. Prof/Civil, welcomes the Resource person for the One-day workshop on “Guidelines For Writing a Research Paper”. Our Head of the Department, Dr.R.Sivakumar, M.E., Ph.D., introduced the Resource person to the participants. Our Resource person Dr.G.Venkatesan, M.E., Ph.D., gave a special keynote address and started his session. The participants learned in detail about Writing a Research Paper. Finally, the session ended with a vote of thanks by the event coordinator Ms.K.Kamalarani, AP/Civil.

Coordinators

  
19/11  
(Ms.K.Kamalarani)

HoD

  
(Dr.R.Sivakumar)

ATTESTED

  
Dr. S. RAMABALAN, M.E., Ph.D.,  
PRINCIPAL

E.G.S. Pillay Engineering College,  
Thethi, Nagore - 611 002.  
Nagapattinam (Dt) Tamil Nadu.

19/11/2018

From

K.Kamalarani  
Assistant Professor,  
Department of Civil Engineering  
E.G.S. Pillay Engineering College,  
Nagapattinam.

To

The Principal  
E.G.S. Pillay Engineering College,  
Nagapattinam.

*BP*  
*19/11/18*

Through

HOD/Civil  
E.G.S. Pillay Engineering College,  
Nagapattinam.

Respected Sir,

Sub: Permission for conducting Workshop – Reg

This is to inform you that our Department of Civil Engineering is going to organize a one-day workshop on “Guidelines for Writing a Research Paper” on 26<sup>th</sup> November 2018. So we request you to kindly permit us for the successful completion of the event.

Thanking you,

*Forwarded and  
recommended to  
Principal.*  
*SA*  
*19.11.18*

*K. Kamalarani*  
Yours truly  
19/11

(K. Kamalarani)

ATTESTED

*[Signature]*  
Dr. S. RAMABALAN, M.E., Ph.D.,  
PRINCIPAL  
E.G.S. Pillay Engineering College,  
Thethi, Nagore - 611 002.  
Nagapattinam (Dt) Tamil Nadu.



# **E.G.S. PILLAY ENGINEERING COLLEGE**

**(An Autonomous Institution,  
Affiliated to Anna University, Chennai)  
Nagapattinam - 611 002, Tamilnadu.**

## **Department of Civil Engineering and**



## **PEACE Association**

One-day Workshop on

# **“Guidelines for Writing a Research Paper”**

Registration Link

<https://forms.gle/3AVtq9qu2tt1fmAQA>

**Resource Person:**

**Dr.G.Venkatesan, M.E.,Ph.D.**

**Assistant Professor (SG),  
Department of Civil Engineering,  
BIT Campus,  
Anna University, Tiruchirappalli**



✉ [hodcivil@egspec.org](mailto:hodcivil@egspec.org)

**Date: 26/11/2018**

☎ +91-9791248202

**ATTESTED**

**Dr. S. RAMABALAN, M.E., Ph.D.,  
PRINCIPAL**

**E.G.S. Pillay Engineering College,  
Thethi, Nagore - 611 002.  
Nagapattinam (Dt) Tamil Nadu.**



# E.G.S. PILLAY ENGINEERING COLLEGE

(An Autonomous Institution, Affiliated to Anna University, Chennai)  
Nagore Post, Nagapattinam – 611 002, Tamilnadu.



## DEPARTMENT OF CIVIL ENGINEERING

### One-day Workshop on Guidelines For Writing a Research Paper 26/11/2018

#### Agenda

| Session                  | Event   |
|--------------------------|---|
| 10.00 a.m. to 10.15 a.m. | <b><u>Inaugural Function:</u></b><br><i>Welcome address:</i><br><b>Dr.R.Elliss Yogesh, Assoc. Prof/Civil</b><br><br><i>Speaker address:</i><br><b>Dr.R.Sivakumar,</b><br><b>Prof &amp; Head, Civil</b>                          |
| 10.15 a.m. to 10.30 a.m. | Tea Break   |
| 10.30 a.m. to 1.00 p.m.  | <b><u>Session I</u></b><br><b>Dr.G.Venkatesan, M.E.,Ph.D.,</b><br><b>Assistant Professor (SG)</b><br><b>Department of Civil Engineering,</b><br><b>University College of Engineering</b><br><b>Tiruchirappalli (BIT Campus)</b> |
| 1.00 p.m. to 2.00 p.m.   | Lunch Break   |
| 2.00 p.m. to 4.00 p.m.   | <b><u>Session II</u></b><br><i>Article Discussion</i>   |
| 4.00 p.m. to 4.15 p.m.   | <b><u>Vote of thanks:</u></b><br><b>Ms.K.Kamalarani, AP/Civil.</b>  |

ATTESTED

  
**Dr. S. RAMABALAN, M.E., Ph.D.,**  
**PRINCIPAL**  
E.G.S. Pillay Engineering College,  
Thethi, Nagore - 611 002.  
Nagapattinam (Dt) Tamil Nadu.



## FACULTY PROFILE

1. Name of the Faculty : Dr.G. Venkatesan
2. Department and Designation : Civil Engineering/ Assistant Professor (SG)
3. Date of Joining : 09.09.2009
4. Faculty ID : TF 0088
5. E-mail Address : [gvenkat1972@yahoo.co.in](mailto:gvenkat1972@yahoo.co.in)
6. Date of Birth : 17.06.1972
7. Qualification : M.E, Ph.D. in Civil Engineering
8. Specialization : Environmental, Water Resources Geotechnical and Structural Engineering



### **9. Professional Experience:**

**Professional Experience: 21 Years (Teaching, Research Experience and Industry experience)**

- Assistant Professor : University College of Engineering Tiruchirappalli (BIT Campus), Anna University, 2009– Present.
- Assistant Professor : SASTRA University, Thanjavur, 2006 –2009.
- TEQIP Research Scholar: National Institute of Technology Tiruchirappalli, 2005 –2006.
- Research Associate : National Institute of Technology Tiruchirappalli, 2002 –2005.
- Project Associate : National Institute of Technology Tiruchirappalli, 2001 –2002

### **10. Research Guidance:**

#### **PhD Awarded-3**

1. S.Lakshminarayanan “ A Adsorption study on Removal of heavy metals from industrial wastewater” ( 07.9.2018)
2. Raja Gopaln. V, “ Potential use of quarry fines with clay landfill liner in prevention of heavy metals transport ”(17.05.2017)
3. Senthil Nathan.U, “Removal of cadmium, chromium and lead in polluted water using low cost adsorbents” (5.11. 2014).

**ATTESTED**

**Dr. S. RAMABALAN, M.E., Ph.D.,  
PRINCIPAL  
E.G.S. Pillay Engineering College,  
Thethi, Nagore - 611 002.  
Tamil Nadu**

### PhD Guidance(Ongoing) –8

1. Senthil.M.S, "Ground water modeling fractured flow aquifer" . (2011 on words- Report Received)
2. Gopinathan S, Durability of aspects of concrete structures, (2011 on words- Report Received )
3. Tamilmani.R, "Prediction of effect of pesticides on soil and ground water".(2011 on words- Confirmation completed )
4. S.Pauline " A comprehensive study on treatment of reverse osmosis brine using capacitive deionization technology" (2015 on words- Synopsis Accepted )
5. Mrs.S.Pitchaikani, "ground water contamination transport modeling for Bhavani River basin " (2014 on words- Confirmation completed)
6. .S.M.Kavitha " Stength and durability study on polymer coated stelfibre reinforced self compacting with copper slag and silica fume" (2015 on words- Confirmation completed)
7. Anjali R," study on strength and durability of concrete"( 2016on words- Confirmation completed)
8. Saravanakumar M," Experimental investigation on flexural behavior and durability study on beam by using high performance light weight concrete" ( 2016 on words- Confirmation completed)

### 11. Awards and Honours :

#### Awards:5

1. **Vishwakarma Award** for the category of Academician for the year 2017organized by Construction Industry Development Council (CIDC),Government of India on 7.3.17.
2. **Rashtriya Gaurav Award** for the year 2015 by the by India International friendship society New Delhi on 15.4.15
3. **Ground water Expert** published in directory of ground water professionals, Central Ground Water Board, Ministry of Water Resources December 2014 to till date.
4. **Best research paper award** on Environmental Issues in the Department of Environment, Government of Tamil Nadu state award for the year of 2012 on 05.06.2013.
5. **Certificate of Recognition** from Eco city builders USA for presentation of Eco city conference 2006.

ATTESTED

  
**Dr. S. RAMABALAN, M.E., Ph.D.,**  
**PRINCIPAL**  
E.G.S. Pillay Engineering College,  
Thethi, Nagore - 611 002.  
Nagapattinam (Dt) Tamil Nadu.



### **Professional Activities and Recognition: 7**

1. **IPHE council Member** of Institution of Public health Engineers, India for the year of 2012 to 2018.
2. Presented on 'Permeable reactive barrier ' **Brain Storming Session on Environmental Geotechnics**' held on January 24-25, 2017, at Goa Organized by Department of Civil Engineering, Indian Institute of Technology Bombay, Mumbai, under the aegis of Science and Engineering Research Board (SERB), Department of Science and Technology (DST) India.
3. **IGS Trichy Chapter Executive committee member** of Indian Geotechnical Society, from 2.10.16 to till date.
4. **IGS Trichy Chapter Founder Secretary**, Indian Geotechnical Society, from 14.2.2014 to 1.10.16.
5. **Member in Environmental and Water Resources Systems Committee**, American Society of Civil Engineers from December 2005 to till date
6. **Chartered Engineer (AM 089348-2)** in Institution of Engineers (India), Kolkatta, from 14.01.2005 to till date.
7. **Outstanding contributions as a reviewer for Environmental Monitoring and Assessment**, Springer publication, 10th July 2013.12. Sponsored Projects:

### **Research and Consultancy Projects: 24**

#### **Sponsored Research Projects: 4**

1. **Studies on structural element by totting tire derived aggregate**, Indian Rubber Manufacturers Research Association (IRMRA), Ministry of Commerce and industry Government of India. IRMRA/DR RK/Dir/16-17/03/01/Ext-R&D dated 10.4.17 (Ongoing)
2. **Tamil Nadu State council Science and Technology, Chennai** sponsored Programme under Student Project Scheme "Green building materials- Solar Tiles - a Case Study (A.Kaviyaran ,M.Krishnamoorthy M.Sanmuga Sakkaravarthy ,TNSCST/SPS/AR/2017-2018 dated 31.01.2018)
3. **Tamil Nadu State council Science and Technology, Chennai** sponsored Programme under Student Project Scheme "Studies on partial replacement of clay by waste tire chips in landfill Liner (C Yogesh prabhu, 2013 TNSCST/SPS/AR/2017-2018 dated 31.01.2018)
4. **Tamil Nadu State council Science and Technology, Chennai** sponsored Programme under Student Project Scheme "Ground improvment technique using low density polymer -

**ATTESTED**

**Dr. S. RAMABALAN, M.E., Ph.D.,  
PRINCIPAL**

**E.G.S. Pillay Engineering College,  
Thethi, Nagore - 611 002.  
Nananattinam (Dt) Tamil Nadu.**

(Abinaya.V, Arunkumar.P,Priya.K, Saravanakkumar.M, TNSCST/SPS/AR/2013-2014 dated 15.04.2014)

**Consultancy Projects: 20**

1. **Validation of Sewage Treatment Plant Design** ,Red Sea Eco Solutions & Instruments (p) Ltd, Chennai dated 23.10.18
2. **Vetting and approving of the design of sewage treatment**, plant , Dugar Homes Chennai dated 15.10.18
3. **Design Adequacy of sewage treatment plant** , Saveetha Medical and Educational Trust, Chennai dated 15.6.18
4. **TNIAMP works -Mix Design for M<sub>15</sub> and M<sub>20</sub> Grade Concrete for a)Distributory No 3,4,5,6 and 8, dated 18.5.18 b) Distributory No 1,2**, Public Works Department NKHLC Section-I Trichy dated 11.7.18
5. a) **Structural design and Drawings for substructures of proposed Road over bridge (LC.No-157) between Varalpattu and Thiruppadirippuliyur stations, Railway Proof checking** , Thomas Iyadurai infrastructure Pvt.Ltd Chennai dated 1.2.18  
b) **Structural design and Drawings for the RCC box of proposed Road under bridge (LC.No-22) between Tirusulam and Pallavarm stations , Railway Proof checking**, G.Sakthi Constructions Railway contractor , Chennai dated 1.2.18
6. **Improvements and Rehabilitation of Irrigation structures in Cauvery Basin- Preparation of Detailed project report(DPR) to improvements and Rehabilitation of Irrigation structures for lower coleroon Anicut system- Determine of conveyance efficiency, Field application efficiency and overall efficiency** Plan formulation PWD, Government of Tamilnadu dated 05.1.18
7. **Construction of Road over bridge in lieu of exiting LC No:323 at Km 399/500-600, Railway Proof checking** Railway contractor dated 20.3.17.
8. **Improvements and Rehabilitation of Irrigation structures in Cauvery Basin- Prepaetion of Detailed project report(DPR) to improvements and Rehabilitation of Rajavoikkal project( Raja, Kumarapalayam&Poiyeri and Mohanur Channels)- Determine of conveyance efficiency, Field application efficiency and overall efficiency** , Plan formulation PWD, Government of Tamilnadu, dated 20.7.16

ATTESTED

**Dr. S. RAMABALAN**, M.E., Ph.D.,  
PRINCIPAL  
E.G.S. Pillay Engineering College,  
Thethi, Nagore - 611 002.  
Nagapattinam (Dt) Tamil Nadu.

9. *Analysis of water and soil samples for EIA study for Desilting of Vagai Dam Reservoir, Pechiparai Reservoir , Mettur Dam Reservoir and Amaravathy Dam in the District of Theni, Kanayakumari , Salem and Tirupurrepectively in Tamil Nadu ,WAPCOS Limited, Ministry of Water Resources, River Development and Ganga Rejuvenation dated 9.3.16 ,*
10. *Ambient Air quality monitoring survey for the proposed Desilting of Vagai Dam Reservoir, Pechiparai Reservoir , Mettur Dam Reservoir and Amaravathy Dam in the District of Theni, Kanayakumari , Salem and Tirupurrepectively in Tamil Nadu ,WAPCOS Limited, Ministry of Water Resources, River Development and Ganga Rejuvenation dated 4.2.16 ,*
11. *Ambient Air quality monitoring survey for the proposed establishment of sea front facilities at Nellore, Andra Pradesh for NIOT, WAPCOS Limited, Ministry of Water Resources, River Development and Ganga Rejuvenation dated 11.2.16*
12. *Ambient Air quality monitoring survey for climate adaptation in vennar sub basin in Cauvery delta project(CAVSCDP):WAPCOS Limited, Ministry of Water Resources, River Development and Ganga Rejuvenation dated 17.10.15 ,*
13. *Analysis of water and soil samples for EIA study" Climate adaptation in Vennar sub basin in Cauvery Delta Project(CAVSCDP) on WAPCOS dated 30.10.15,*
14. *Conducting siltation studies for silt factor at Grand Anicut canal projecton WAPCOS dated dated 27.10.15,*
15. *Third party quality control and assurance executed by CPWD at National Institute of Technology Tiruchirappallion 18.09.2015*
16. *Coordinator for empanelment agencies for imparting training to civil Engineers, Architects and masons titled on "Cost-Effective and Disaster Resistant Technologies" organized by Building Materials and Technology Promotion Council Ministry of Housing and Urban Poverty Alleviation ,Government of India, New Delhi held at Bharathidasn Institute of Technology , Tiruchirappalli, on 26th and 27th February 2015*
17. *Testing of Water sample Valady to Manaparai Railway line project for southern railway Contractor: CDM smith (P) Ltd.Bengaluru. dated 17.11.2014 ,*
18. *Water quality analysis Valady to Manaparai Railway line project for southern railway Contractor: CDM smith (P) Ltd.Bengaluru. dated 16.7.2013 ,*

ATTESTED

  
**Dr. S. RAMABALAN, M.E., Ph.D.,**  
**PRINCIPAL**  
E.G.S. Pillay Engineering College,  
Thethi, Nagore - 611 002.  
Nagapattinam (Dt) Tamil Nadu.

### 13. Publications

#### PUBLICATIONS :

#### Website:

Google Scholar : <https://scholar.google.co.in/citations?hl=en&user=w1icd8YAAAAJ>  
Researchgate : [http://www.researchgate.net/profile/Venkatesan\\_Govindan4](http://www.researchgate.net/profile/Venkatesan_Govindan4)  
academia.edu : <https://annauniv.academia.edu/VenkatesanGovindan>  
Orchid id : [orcid.org/0000-0001-5159-4265](https://orcid.org/0000-0001-5159-4265)  
Researcher ID : M-3232-2014  
Twitter : [venki@gvenkat2018](https://twitter.com/venki@gvenkat2018)  
Kudos : <https://www.growkudos.com/hub/133400/publications>  
Cited by

|           | All | Since 2013 |
|-----------|-----|------------|
| Citations | 76  | 66         |
| h-index   | 4   | 4          |
| i10-index | 2   | 2          |

Publication in Journals– 38

Publication in Refereed journals–26

ATTESTED

  
**Dr. S. RAMABALAN, M.E., Ph.D.,**  
**PRINCIPAL**  
E.G.S. Pillay Engineering College,  
Thethi, Nagore - 611 002.  
Nagapattinam (Dt) Tamil Nadu.





# E.G.S. PILLAY ENGINEERING COLLEGE











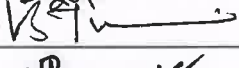

(An Autonomous Institution, Affiliated to Anna University, Chennai)  
Nagore Post, Nagapattinam – 611 002, Tamilnadu.

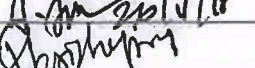
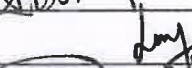
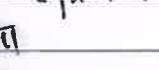
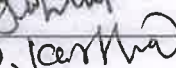
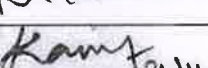
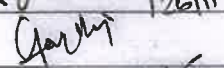

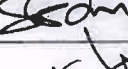
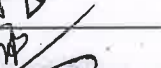
## DEPARTMENT OF CIVIL ENGINEERING

One-day Workshop on  
**Guidelines For Writing a Research Paper**  
26/11/2018

### Participants Attendance

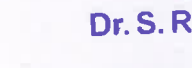
| S. No | Name                 | Signature   |
|-------|----------------------|---|
| 1.    | Sivakumar R          |    |
| 2.    | Malliga P            |     |
| 3.    | Balasubramani V      |     |
| 4.    | Vethamoorthy N R     |     |
| 5.    | Arjunan A            |    |
| 6.    | Krishnapriya R       |   |
| 7.    | Prakash G            |  |
| 8.    | Neelaveni R          |   |
| 9.    | Subita Deeneshwari M |   |
| 10.   | Karthika N           |   |
| 11.   | Kamalarani K         |   |
| 12.   | Gayathri M           |   |
| 13.   | Adhavanathan T       |  |
| 14.   | Shyam Sundar S       |   |
| 15.   | Venkatesan E         |   |
| 16.   | Anbarasan M          |   |
| 17.   | Britto J             |   |
| 18.   | Senthamil Maran K    |   |
| 19.   | Srinivasan V         |  |
| 20.   | Pirakasam A          |   |

**ATTESTED**  
  
**Dr. S. RAMABALAN, M.E., Ph.D.,**  
**PRINCIPAL**  
E.G.S. Pillay Engineering College,  
Thethi, Nagore - 611 002.  
Nagapattinam (Dt) Tamil Nadu.

# E.G.S. PILLAY ENGINEERING COLLEGE, NAGAPATTINAM.

## FEEDBACK FORM

Name of the Department : Civil Engineering  
Nature of the event : Workshop  
Title of the Event : Guidelines for Writing a Research Paper  
Resource Person : Dr.G.Venkatesan  
Date : 26/11/2018  
Coordinators Name : Ms.K.Kamalarani

### Ratings have been provided on a 5-point scale

You strongly disagree with the statement - 1  
You disagree with the statement - 2  
You neither agree nor disagree with the statement - 3  
You agree with the statement - 4  
You strongly agree with the statement - 5 ✓

### About the Content of the Program

|   |     |     |   |   |   |
|---|-----|-----|---|---|---|
| The Program content was relevant for me           | 5   | 4 ✓ | 3 | 2 | 1 |
| The content of the program was very comprehensive | 5 ✓ | 4   | 3 | 2 | 1 |
| The content of the program was not repeated       | 5 ✓ | 4   | 3 | 2 | 1 |
| The overall content of the program was excellent  | 5 ✓ | 4   | 3 | 2 | 1 |

### About Resource person and Presentation

|  |     |     |   |   |   |
|--|-----|-----|---|---|---|
| The speaker had very strong expertise in areas | 5 ✓ | 4   | 3 | 2 | 1 |
| The speaker had excellent communication skills | 5   | 4 ✓ | 3 | 2 | 1 |
| The speaker made the program very interesting  | 5 ✓ | 4   | 3 | 2 | 1 |
| The speaker was very well prepared for program | 5 ✓ | 4   | 3 | 2 | 1 |

### About the Guest Lecture

|  |     |   |   |   |   |
|--|-----|---|---|---|---|
| The timings were very convenient                 | 5 ✓ | 4 | 3 | 2 | 1 |
| The pedagogy used as very appropriate            | 5 ✓ | 4 | 3 | 2 | 1 |
| There were sufficient breaks in between sessions | 5 ✓ | 4 | 3 | 2 | 1 |

### Assessment

|   |     |     |   |   |   |
|---|-----|-----|---|---|---|
| The assessment was very suitable        | 5   | 4 ✓ | 3 | 2 | 1 |
| The assessment was not at all difficult | 5 ✓ | 4   | 3 | 2 | 1 |

This question is answered on a 10-point scale with 1 being highly unlikely to recommend and 10 being will highly recommend.

Overall Experience      1      2      3      4      5      6      7      8 ✓      9      10

Name : Balasubramani V

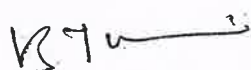
Signature : 

ATTESTED

  
Dr. S. RAMABALAN, M.E., Ph.D.,  
PRINCIPAL

E.G.S. Pillay Engineering College,  
Thethi, Nagore - 611 002.  
Nagapattinam (Dt) Tamil Nadu.



# E.G.S. PILLAY ENGINEERING COLLEGE, NAGAPATTINAM.

## FEEDBACK FORM

Name of the Department : Civil Engineering  
Nature of the event : Workshop  
Title of the Event : Guidelines for Writing a Research Paper  
Resource Person : Dr.G.Venkatesan  
Date : 26/11/2018  
Coordinators Name : Ms.K.Kamalarani

### Ratings have been provided on a 5-point scale

You strongly disagree with the statement - 1  
You disagree with the statement - 2  
You neither agree nor disagree with the statement - 3  
You agree with the statement - 4  
You strongly agree with the statement - 5

### About the Content of the Program

The Program content was relevant for me 5 4 3 2 1  
The content of the program was very comprehensive 5 4 3 2 1  
The content of the program was not repeated 5 4 3 2 1  
The overall content of the program was excellent 5 4 3 2 1

### About Resource person and Presentation

The speaker had very strong expertise in areas 5 4 3 2 1  
The speaker had excellent communication skills 5 4 3 2 1  
The speaker made the program very interesting 5 4 3 2 1  
The speaker was very well prepared for program 5 4 3 2 1

### About the Guest Lecture

The timings were very convenient 5 4 3 2 1  
The pedagogy used as very appropriate 5 4 3 2 1  
There were sufficient breaks in between sessions 5 4 3 2 1

### Assessment

The assessment was very suitable 5 4 3 2 1  
The assessment was not at all difficult 5 4 3 2 1

This question is answered on a 10-point scale with 1 being highly unlikely to recommend and 10 being will highly recommend.

Overall Experience 1 2 3 4 5 6 7 8 9 10

Name : E. Venkatesan

Signature : E. Venkatesan

ATTESTED  
  
Dr. S. RAMABALAN, M.E., Ph.D.,  
PRINCIPAL  
E.G.S. Pillay Engineering College,  
Thethi, Nagore - 611 002.  
Nagapattinam (Dt) Tamil Nadu.

# E.G.S. PILLAY ENGINEERING COLLEGE, NAGAPATTINAM.

## FEEDBACK FORM

Name of the Department : Civil Engineering  
Nature of the event : Workshop  
Title of the Event : Guidelines for Writing a Research Paper  
Resource Person : Dr.G.Venkatesan  
Date : 26/11/2018  
Coordinators Name : Ms.K.Kamalarani

### Ratings have been provided on a 5-point scale

You strongly disagree with the statement - 1  
You disagree with the statement - 2  
You neither agree nor disagree with the statement - 3  
You agree with the statement - 4  
You strongly agree with the statement - 5 ✓

### About the Content of the Program

|   |   |   |   |   |   |   |
|---|---|---|---|---|---|---|
| The Program content was relevant for me           | 5 | ✓ | 3 | 2 | 1 |   |
| The content of the program was very comprehensive | 5 | ✓ | 4 | 3 | 2 | 1 |
| The content of the program was not repeated       | 5 | ✓ | 4 | 3 | 2 | 1 |
| The overall content of the program was excellent  | 5 | ✓ | 4 | 3 | 2 | 1 |

### About Resource person and Presentation

|  |   |   |   |   |   |   |
|--|---|---|---|---|---|---|
| The speaker had very strong expertise in areas | 5 | ✓ | 4 | 3 | 2 | 1 |
| The speaker had excellent communication skills | 5 | ✓ | 4 | 3 | 2 | 1 |
| The speaker made the program very interesting  | 5 | ✓ | 4 | 3 | 2 | 1 |
| The speaker was very well prepared for program | 5 | ✓ | 4 | 3 | 2 | 1 |

### About the Guest Lecture

|  |   |   |   |   |   |   |
|--|---|---|---|---|---|---|
| The timings were very convenient                 | 5 | ✓ | 4 | 3 | 2 | 1 |
| The pedagogy used as very appropriate            | 5 | ✓ | 4 | 3 | 2 | 1 |
| There were sufficient breaks in between sessions | 5 | ✓ | 4 | 3 | 2 | 1 |

### Assessment

|   |   |   |   |   |   |   |
|---|---|---|---|---|---|---|
| The assessment was very suitable        | 5 | ✓ | 4 | 3 | 2 | 1 |
| The assessment was not at all difficult | 5 | ✓ | 4 | 3 | 2 | 1 |

This question is answered on a 10-point scale with 1 being highly unlikely to recommend and 10 being will highly recommend.

Overall Experience 1 2 3 4 5 6 7 8 ✓ 9 10

Name : A. PIRAKASAM

Signature :



ATTESTED



Dr. S. RAMABALAN, M.E., Ph.D.,  
PRINCIPAL

E.G.S. Pillay Engineering College,  
Thethi, Nagore - 611 002.  
Nagapattinam (Dt) Tamil Nadu.

# E.G.S. PILLAY ENGINEERING COLLEGE, NAGAPATTINAM.

## FEEDBACK FORM

Name of the Department : Civil Engineering  
Nature of the event : Workshop  
Title of the Event : Guidelines for Writing a Research Paper  
Resource Person : Dr.G.Venkatesan  
Date : 26/11/2018  
Coordinators Name : Ms.K.Kamalarani

### Ratings have been provided on a 5-point scale

You strongly disagree with the statement - 1  
You disagree with the statement - 2  
You neither agree nor disagree with the statement - 3  
You agree with the statement - 4  
You strongly agree with the statement - 5

### About the Content of the Program

The Program content was relevant for me 5/ 4 3 2 1  
The content of the program was very comprehensive 5/ 4 3 2 1  
The content of the program was not repeated 5/ 4 3 2 1  
The overall content of the program was excellent 5/ 4 3 2 1

### About Resource person and Presentation

The speaker had very strong expertise in areas 5 4/ 3 2 1  
The speaker had excellent communication skills 5 4/ 3 2 1  
The speaker made the program very interesting 5 4/ 3 2 1  
The speaker was very well prepared for program 5/ 4 3 2 1

### About the Guest Lecture

The timings were very convenient 5 4/ 3 2 1  
The pedagogy used as very appropriate 5/ 4 3 2 1  
There were sufficient breaks in between sessions 5/ 4 3 2 1

### Assessment

The assessment was very suitable 5 4/ 3 2 1  
The assessment was not at all difficult 5/ 4 3 2 1

This question is answered on a 10-point scale with 1 being highly unlikely to recommend and 10 being will highly recommend.

Overall Experience 1 2 3 4 5 6 7 8/ 9 10

Name : N. Karthick

Signature : 

ATTESTED  
  
Dr. S. RAMABALAN, M.E., Ph.D.,  
PRINCIPAL  
E.G.S. Pillay Engineering College,  
Thethi, Nagore - 611 002.  
Nagapattinam (Dt) Tamil Nadu.

# E.G.S. PILLAY ENGINEERING COLLEGE, NAGAPATTINAM.

## FEEDBACK FORM

Name of the Department : Civil Engineering  
Nature of the event : Workshop  
Title of the Event : Guidelines for Writing a Research Paper  
Resource Person : Dr.G.Venkatesan  
Date : 26/11/2018  
Coordinators Name : Ms.K.Kamalarani

### Ratings have been provided on a 5-point scale

You strongly disagree with the statement - 1  
You disagree with the statement - 2  
You neither agree nor disagree with the statement - 3  
You agree with the statement - 4  
You strongly agree with the statement - 5

### About the Content of the Program

|   |   |   |   |   |   |
|---|---|---|---|---|---|
| The Program content was relevant for me           | 5 | 4 | 3 | 2 | 1 |
| The content of the program was very comprehensive | 5 | 4 | 3 | 2 | 1 |
| The content of the program was not repeated       | 5 | 4 | 3 | 2 | 1 |
| The overall content of the program was excellent  | 5 | 4 | 3 | 2 | 1 |

### About Resource person and Presentation

|  |   |   |   |   |   |
|--|---|---|---|---|---|
| The speaker had very strong expertise in areas | 5 | 4 | 3 | 2 | 1 |
| The speaker had excellent communication skills | 5 | 4 | 3 | 2 | 1 |
| The speaker made the program very interesting  | 5 | 4 | 3 | 2 | 1 |
| The speaker was very well prepared for program | 5 | 4 | 3 | 2 | 1 |

### About the Guest Lecture

|  |   |   |   |   |   |
|--|---|---|---|---|---|
| The timings were very convenient                 | 5 | 4 | 3 | 2 | 1 |
| The pedagogy used as very appropriate            | 5 | 4 | 3 | 2 | 1 |
| There were sufficient breaks in between sessions | 5 | 4 | 3 | 2 | 1 |

### Assessment

|   |   |   |   |   |   |
|---|---|---|---|---|---|
| The assessment was very suitable        | 5 | 4 | 3 | 2 | 1 |
| The assessment was not at all difficult | 5 | 4 | 3 | 2 | 1 |

This question is answered on a 10-point scale with 1 being highly unlikely to recommend and 10 being will highly recommend.

Overall Experience                      1        2        3        4        5        6        7        8        9        10

Name : SUBITHA PHEENESH MARY . M

Signature :

ATTESTED

Dr. S. RAMABALAN, M.E., Ph.D.  
PRINCIPAL

E.G.S. Pillay Engineering College,  
Thethi, Nagore - 611 002.  
Nagapattinam (Dt) Tamil Nadu.





# CERTIFICATE

## OF PARTICIPATION

This is to certify that **Britto J** from **E.G.S.Pillay Engineering College** has attended the One-day Workshop on "**Guidelines For Writing a Research Paper**" organized by Department of Civil Engineering, E.G.S.Pillay Engineering College (Autonomous), Nagapattinam on 26<sup>th</sup> November 2018.



Coordinator

HOD/Civil

ATTESTED



**Dr. S. RAMABALAN, M.E., Ph.D.,**  
PRINCIPAL

E.G.S. Pillay Engineering College,  
Thethi, Nagore - 611 002,  
Nagapattinam (Dt) Tamil Nadu.

.....  
.....  
.....

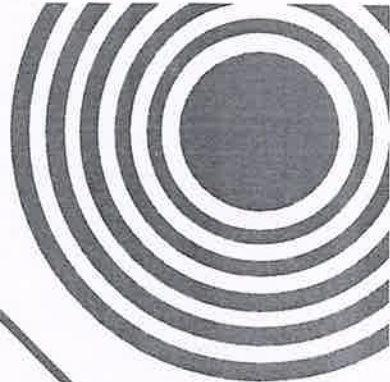



# CERTIFICATE

## OF PARTICIPATION

This is to certify that **Anbarasan M** from **E.G.S.Pillay Engineering College** has attended the One-day Workshop on **"Guidelines For Writing a Research Paper"** organized by Department of Civil Engineering, E.G.S.Pillay Engineering College (Autonomous), Nagapattinam on 26<sup>th</sup> November 2018.

*K. Ramani*

Coordinator

.....  
.....  
.....

*[Signature]*

HOD/Civil

ATTESTED

*[Signature]*

**Dr. S. RAMABALAN, M.E., Ph.D.,**  
PRINCIPAL

E.G.S. Pillay Engineering College,  
Thethi, Nagore - 611 002.  
Nagapattinam (Dt) Tamil Nadu.





# CERTIFICATE

## OF PARTICIPATION

This is to certify that **Senthamil Maran K** from **E.G.S.Pillay Engineering College** has attended the One-day Workshop on **"Guidelines For Writing a Research Paper"** organized by Department of Civil Engineering, E.G.S.Pillay Engineering College (Autonomous), Nagapattinam on 26<sup>th</sup> November 2018.



Coordinator

ATTESTED

HOD/Civil



**Dr. S. RAMABALAN, M.E., Ph.D.,**  
PRINCIPAL

E.G.S. Pillay Engineering College,  
Thethi, Nagore - 611 002.  
Nagapattinam (Dt) Tamil Nadu.

.....  
.....  
.....





# CERTIFICATE

## OF PARTICIPATION

This is to certify that **Subita Deeneshwari M** from **E.G.S.Pillay Engineering College** has attended the One-day Workshop on **"Guidelines For Writing a Research Paper"** organized by Department of Civil Engineering, E.G.S.Pillay Engineering College (Autonomous), Nagapattinam on 26<sup>th</sup> November 2018.

*R. Ramani*

*[Signature]*

Coordinator

HOD/Civil

ATTESTED

*[Signature]*

**Dr. S. RAMABALAN, M.E., Ph.D.,  
PRINCIPAL**

E.G.S. Pillay Engineering College,  
Thethi, Nagore - 611 002.  
Nagapattinam (Dt) Tamil Nadu.

.....  
.....  
.....

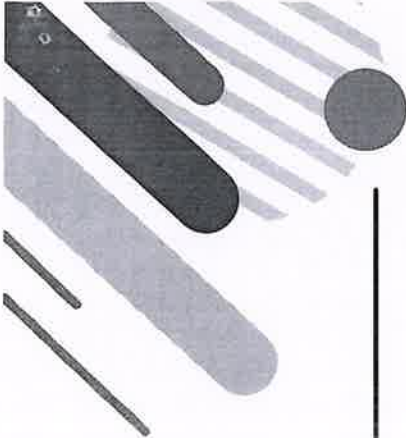



# CERTIFICATE

## OF PARTICIPATION

This is to certify that **Gayathri M** from **E.G.S.Pillay Engineering College** has attended the One-day Workshop on **"Guidelines For Writing a Research Paper"** organized by Department of Civil Engineering, E.G.S.Pillay Engineering College (Autonomous), Nagapattinam on 26<sup>th</sup> November 2018.



Coordinator

ATTESTED

HOD/Civil

**Dr. S. RAMABALAN, M.E., Ph.D.,**  
PRINCIPAL

E.G.S. Pillay Engineering College,  
Thethi, Nagore - 611 002.  
Nagapattinam (Dt) Tamil Nadu.

• • • • •  
• • • • •  
• • • • •





**E.G.S. PILLAY ENGINEERING COLLEGE  
(AUTONOMOUS)**

**NAGAPATTINAM - 611 002**

Accredited by NAAC with 'A' grade, Accredited by NBA (EEE, CSE & MECH)  
Approved by AICTE – New Delhi, Affiliated to Anna University, Chennai

One day Seminar

on

**“EMBEDDED SYSTEM”**

**Organized by**

Department of Electrical & Electronics Engineering

Venue: Seminar Hall

02<sup>nd</sup> April 2019

**ATTESTED**

**Dr. S. RAMABALAN, M.E., Ph.D.,  
PRINCIPAL**

**E.G.S. Pillay Engineering College,  
Thethi, Nagore - 611 002.  
Nagapattinam (Dt) Tamil Nadu.**



**E.G.S.PILLAY ENGINEERING COLLEGE, NAGAPATTINAM**  
**DEPARTMENT OF ELECTRICAL & ELECTRONICS ENGINEERING**

**EMBEDDED SYSTEM**

**TABLE OF CONTENT**

| S.NO | PARTICULARS                     |
|------|---------------------------------|
| 1.   | Report                          |
| 2.   | Approval letter to Principal    |
| 3.   | Proposed budget                 |
| 4.   | Circular                        |
| 5.   | Attendance                      |
| 6.   | Course material                 |
| 7.   | Photos                          |
| 8.   | Feedback form from participants |
| 9.   | Expenditure details             |
| 10.  | Newspaper samples               |

ATTESTED

  
**Dr. S. RAMABALAN, M.E., Ph.D.,**  
**PRINCIPAL**

**E.G.S. Pillay Engineering College,**  
**Thethi, Nagore - 611 002.**  
**Nagapattinam (Dt) Tamil Nadu.**

# E.G.S. PILLAY ENGINEERING COLLEGE, NAGAPATTINAM

(Autonomous)

Accredited by NAAC with 'A' Grade

Department of Electrical and Electronics Engineering

(Accredited by NBA)



## A REPORT ON ONE DAY SEMINAR

ON

## **EMBEDDED SYSTEM**

Initially, Department of EEE, E.G.S.Pillay Engineering College, Nagapattinam is planned to organize a lecture workshop for non-teaching faculty members of E.G.S. pillay group of institutions and through discussions it was coined as "EMBEDDED SYSTEM". The program was jointly organized by internal quality assurance cell (IQAC). The coordinator identified for this workshop is Prof. S.Sivamani of EEE department

Internal Experts Dr.V.MOHAN. Professor/HOD/EEE, Dr.T.Suresh Padmanabhan. Professor/EEE was fixed to handle the sessions. The session was inaugurated by the Hon'ble secretary of the Institution Shri.S.Paramesvaran, Principal Dr.S.Ramabalan and controller of Examination Dr.M.Chinnadurai. Prof K.Nandakumar welcomed the gathering and followed by inaugural speech by Dr.V.Mohan, HOD/EEE

The session was started by the Internal Expert Dr.T.Suresh Padmanabhan Professor/EEE with the lecture on "Introduction to embedded system" The final session was handled by Dr. V.Mohan with the lecture on "Registers & Memory of AT89C51". He created an impact and awareness about need for power conservation and its benefits.

Finally, certificates were distributed to all the participants and vote of thanks was proposed by one of the program coordinator Prof. S.Sivamani of the department of EEE.

COORDINATOR

(Mr. S.Sivamani)

HOD/EEE

(Dr.V.Mohan)

ATTESTED  
  
Dr. S. RAMABALAN, M.E., Ph.D.,  
PRINCIPAL  
E.G.S. Pillay Engineering College,  
Thethi, Nagore - 611 002.  
Nagapattinam (Dt) Tamil Nadu.



Nagapattinam,

25-03-2019

From

Dr.V.Mohan,  
Professor & Head - EEE,  
Dept. of Electrical and Electronics Engineering,  
E.G.S.Pillay Engineering College,  
Nagapattinam.

To

The Principal,  
E.G.S.Pillay Engineering College,  
Nagapattinam.

Respected Sir,

Sub: Requesting permission to conduct one day seminar on "EMBEDDED SYSTEM" on 2<sup>nd</sup> April 2019 - Reg.,

In association with IQAC, we are planning to organize a one day seminar on "EMBEDDED SYSTEM" on 2<sup>nd</sup> April 2019 for all teaching staff. Internal facilities have been confirmed to handle the sessions. To organize this lecture, we seek your permission and we need an amount of Rs. 4,800/- (Rupees four thousand and eight hundred only) for organizing this workshop successfully. So, kindly approve for the above said fund towards this workshop.

Thanking You.

Encl Details:

1. Schedule of the Course.
2. Estimated Budget.

Yours sincerely,

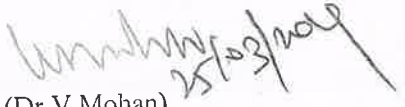
  
(Dr. V. Mohan)

ATTESTED

  
Dr. S. RAMABALAN, M.E., Ph.D.,  
PRINCIPAL

E.G.S. Pillay Engineering College,  
Thethi, Nagore - 611 002,  
Nagapattinam (Dt) Tamil Nadu:

Nagapattinam,

25-03-2019

From

Dr.V.Mohan,  
Professor & Head - EEE,  
Dept. of Electrical and Electronics Engineering,  
E.G.S.Pillay Engineering College,  
Nagapattinam.

To

The Hon'ble Secretary,  
E.G.S.Pillay Engineering College,  
Nagapattinam.

Respected Sir,

Sub: Requesting permission to conduct one day seminar on "EMBEDDED SYSTEM" on 2<sup>nd</sup> April 2019 – Reg.,

In association with IQAC, we are planning to organize a one day seminar on "EMBEDDED SYSTEM" on 2<sup>nd</sup> April 2019 for all teaching staff. Internal facilities have been confirmed to handle the sessions. To organize this lecture, we seek your permission and we need an amount of Rs. 4,800/- (**Rupees four thousand and eight hundred only**) for organizing this workshop successfully. So, kindly approve for the above said fund towards this workshop.

Thanking You.

Encl Details:

1. Schedule of the Course.
2. Estimated Budget.

Yours sincerely,

(Dr.V.Mohan)

**ATTESTED**

**Dr. S. RAMABALAN, M.E., Ph.D.,  
PRINCIPAL**

**E.G.S. Pillay Engineering College,  
Thethi, Nagore - 611 002.**

**Nagapattinam (Dt) Tamil Nadu.**

(i) **Schedule:**

| Date                       | Time                | Session details                     | Resource Person                        |
|----------------------------|---------------------|-------------------------------------|--|
| 2 <sup>nd</sup> April 2019 | 9.30am - 10.00am    | Inauguration                        | Staff & Students                       |
|                            | 10.00am - 12.00am   | Electrical system introduction      | Dr.T.Suresh Padmanabhan. Professor/EEE |
|                            | 12.00 pm - 01.00 pm | Lunch break                         | -                                      |
|                            | 01.00 pm - 04.00 pm | Registers & Memory of AT89C51       | Dr.V.MOHAN. Professor/HOD/EEE          |
|                            | 04.00 pm - 04.20 pm | Tea break                           | -                                      |
|                            | 04.20 pm - 04.50 pm | Feedback & certificate distribution | All teaching staff                     |

(ii) **Participants details:**

| Participants details | Maximum Number of participants |
|----------------------|--------------------------------|
| All Teaching staff   | 38                             |

(iii) **Estimated Budget**

| SI.NO               | ITEMS DESCRIPTION               | QUANTITY REQUIRED | AMOUNT / QUANTITY IN RS. | ESTIMATED AMOUNT IN RS. |
|---------------------|---------------------------------|-------------------|--------------------------|-------------------------|
| 1.                  | Tea ,Snacks & Lunch             | 50 (2 session)    | 40                       | 2000                    |
| 2.                  | Flex                            | 1                 | -                        | 400                     |
| 3.                  | Media                           | -                 | 500 (2 papers)           | 1000                    |
| 4.                  | Invitation & report preparation | -                 | 300                      | 300                     |
| 5.                  | Certificate                     | 40                | 10                       | 400                     |
| 6.                  | Workshop Kit                    | 40                | 18                       | 700                     |
| <b>Total Amount</b> |                                 |                   |                          | <b>4800</b>             |

| Resource Person  | Convener                              | Program Coordinators   |
|--|---------------------------------------|------------------------|
| Dr.V.MOHAN. Professor/HOD/EEE<br>Dr.T.SURESH PADMANABHAN.<br>Professor/EEE | Dr.V.Mohan,<br>Professor & Head - EEE | Mr. S.Sivamani, AP/EEE |

**ATTESTED**  
  
**Dr. S. RAMABALAN, M.E., Ph.D.,**  
**PRINCIPAL**  
**E.G.S. Pillay Engineering College,**  
**Thethi, Nagore - 611 002.**  
**Nagapattinam (Dt) Tamil Nadu.**



**E.G.S. PILLAY ENGINEERING COLLEGE, Nagapattinam**  
(Autonomous)  
Accredited by NAAC with 'A' Grade  
Department of Electrical and Electronics Engineering  
(Accredited by NBA)  
CIRCULAR



Date: 25-03-2019.

We are happy to announce that a one day seminar on "EMBEDDED SYSTEM" is going to be organized by the department of EEE in association with IQAC on 2<sup>nd</sup> April 2019 for all teaching staff of our Institution. All Supporting staff and also interested faculty members are requested to register their names to Mr.S.Sivamani, AP/EEE on or before 27.03.2019.

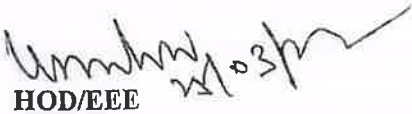
  
HOD/EEE

  
Principal

- Copy to: 1. The Honorable Secretary, EGSPEC  
2. The Principal, EGSPEC  
3. All Department Notice Board



**E.G.S. PILLAY ENGINEERING COLLEGE, Nagapattinam**  
(Autonomous)  
Accredited by NAAC with 'A' Grade  
Department of Electrical and Electronics Engineering  
(Accredited by NBA)  
CIRCULAR



Date: 25-03-2019.

We are happy to announce that a one day seminar on "EMBEDDED SYSTEM" is going to be organized by the department of EEE in association with IQAC on 2<sup>nd</sup> April 2019 for all teaching staff of our Institution. All Supporting staff and also interested faculty members are requested to register their names to Mr.S.Sivamani, AP/EEE on or before 27.03.2019.

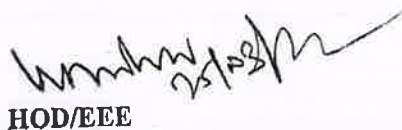
  
HOD/EEE

  
Principal

- Copy to: 1. The Honorable Secretary, EGSPEC  
2. The Principal, EGSPEC  
3. All Department Notice Board

**ATTESTED**  
  
**Dr. S. RAMABALAN, M.E., Ph.D.,**  
**PRINCIPAL**  
E.G.S. Pillay Engineering College,  
Thethi, Nagore - 611 002.  
Nagapattinam (Dt) Tamil Nadu.





# E.G.S. PILLAY ENGINEERING COLLEGE, Nagapattinam

(Autonomous)

Accredited by NAAC with 'A' Grade

Department of Electrical and Electronics Engineering

(Accredited by NBA)



## ONE DAY SEMINAR ON

# EMBEDDED SYSTEM

Date: 02.04.2019

Venue: Seminar Hall

### ATTENDANCE

| S.NO | STAFF NAME               | DEPARTMENT | IN | AN |
|------|--------------------------|------------|----|----|
| 1.   | SIVAMANI.S               | EEE        |    |    |
| 2.   | DR.T.SURESH PRADHAN      | EEE        |    |    |
| 3.   | DR. M. VIJAYAKUMAR       | EEE        |    |    |
| 4.   | S. Laksh                 | EEE        |    |    |
| 5.   | B. AMALDE NAUSEEN ANTONY | EEE        |    |    |
| 6.   | T. Senthil Kumar         | EEE        |    |    |
| 7.   | MR. R. Anandraj          | EEE        |    |    |
| 8.   | SURESH                   | EEE        |    |    |
| 9.   | MR. YOKESWARAN           | EEE        |    |    |
| 10.  | MR. S. Chitra            | ECE        |    |    |
| 11.  | MR. S. Anandharaj        | ECE        |    |    |
| 12.  | MR. A. Prakasham         | CIVIL      |    |    |
| 13.  | MR. KOTESWARI            | ECE        |    |    |
| 14.  | G. Sundaravadiuel        | Mech.      |    |    |
| 15.  | G. MURUGESH              | MECH       |    |    |
| 16.  | D. SETHIL KUNAR          | EEE        |    |    |

ATTESTED

Dr. S. RAMABALAN, M.E., Ph.D.,  
PRINCIPAL

|     |                        |       |                    |                    |
|-----|------------------------|-------|--------------------|--------------------|
| 17. | Dr. D. Devarajan.      | ECE   | D. Devarajan.      | D. Devarajan.      |
| 18. | Dr. Istiaq Hossain.    | ECE   | Istiaq Hossain.    | Istiaq Hossain.    |
| 19. | Mr. K. Raju.           | IT    | K. Raju.           | K. Raju.           |
| 20. | Mrs. S. Saranya.       | CSE   | S. Saranya.        | S. Saranya.        |
| 21. | K. Kothiga.            | ECE   | K. Kothiga.        | K. Kothiga.        |
| 22. | N. Manikandan.         | MECH  | N. Manikandan.     | N. Manikandan.     |
| 23. | Mrs. Sangeetha.        | MBA   | Sangeetha.         | Sangeetha.         |
| 24. | Mrs. Rajanmal.         | CSE   | Rajanmal.          | Rajanmal.          |
| 25. | Mr. S. Srinivasan.     | ECE   | S. Srinivasan.     | S. Srinivasan.     |
| 26. | J. Jaganmala.          | MECH  | J. Jaganmala.      | J. Jaganmala.      |
| 27. | E. Venkatesan.         | CIVIL | E. Venkatesan.     | E. Venkatesan.     |
| 28. | Dr. Sivarama Krishnan. | MECH  | Sivarama Krishnan. | Sivarama Krishnan. |
| 29. | K. Pradeepa.           | CSE   | K. Pradeepa.       | K. Pradeepa.       |
| 30. | Natal Srinivasan.      | ECE   | Natal Srinivasan.  | Natal Srinivasan.  |
| 31. | Mr. R. Anand Babu.     | IT    | R. Anand Babu.     | R. Anand Babu.     |
| 32. | S. Senthil Kumar.      | ECE   | S. Senthil Kumar.  | S. Senthil Kumar.  |
| 33. | Mr. J. Noorul Aheen.   | CSE   | J. Noorul Aheen.   | J. Noorul Aheen.   |
| 34. | M. Nagalakshmi.        | IT    | M. Nagalakshmi.    | M. Nagalakshmi.    |
| 35. | P. Anand Raj.          | CSE   | P. Anand Raj.      | P. Anand Raj.      |
| 36. | B. Ranjani.            | CSE   | B. Ranjani.        | B. Ranjani.        |
| 37. | S. Shyam Sundar.       | CIVIL | S. Shyam Sundar.   | S. Shyam Sundar.   |
| 38. | A. Arun Kumar.         | MECH  | A. Arun Kumar.     | A. Arun Kumar.     |

ATTESTED

  
**Dr. S. RAMABALAN, M.E., Ph.D.,**  
**PRINCIPAL**

E.G.S. Pillay Engineering College,  
Thethi, Nagore - 611 002.  
Nagapattinam (Dt) Tamil Nadu.

  
HOD/EEE  
(Dr. V. Mohan)

# E.G.S. PILLAY ENGINEERING COLLEGE

Nagapattinam  
(Autonomous)



Accredited by NAAC with 'A' Grade  
Department of Electrical and Electronics Engineering  
(Accredited by NBA)

## CORDIALLY INVITES YOU ALL FOR

ONE DAYS SEMINAR

ON

### EMBEDDED SYSTEM

Date: 02.04.2019

Venue: Seminar Hall

**Smt. Jothimani G.S. Pillay**  
Chairman – EGSP group of Institutions

**Chev. S. Paramesvaran**  
Secretary - EGSP group of Institutions

**Dr.S.Ramabalan**  
Principal

**Dr.V.Mohan**  
HOD/EEE

**ATTESTED**  
  
**Dr. S. RAMABALAN, M.E., Ph.D.,**  
**PRINCIPAL**  
E.G.S. Pillay Engineering College,  
Thethi, Nagore - 611 002.  
Nagapattinam (Dt) Tamil Nadu.

## Embedded Systems

- Computing systems performing specific tasks within a framework of real-world constraints
  - Automotive: ECS, ABS; Aircraft
  - Network Appliances: Routers, Modems
  - Cell Phones, PDA, Mouse, E-Star Power
  - Printers, Hand Mixers, Toasters, Tires!
- Microprocessors are Ubiquitous

## Embedded Systems Everywhere!

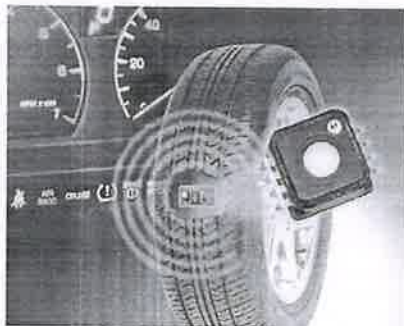

Tire Pressure Sender



SmartPen

ATTESTED

  
**Dr. S. RAMABALAN**, M.E., Ph.D.,  
PRINCIPAL  
E.G.S. Pillay Engineering College,  
Thethi, Nagore - 611 002.  
Nagapattinam (Dt) Tamil Nadu.



## Characteristics of Embedded Systems

- Part of larger system
  - *not* a “computer with keyboard, display, etc.”
- HW & SW application-specific – not G.P.
  - application is known a-priori
  - definition and development concurrent
- Interact (sense, manipulate, communicate) with the external world
- Never terminate (ideally)
- Operation is *time constrained*: latency, throughput
- Other constraints: power, size, weight, heat, reliability
- Increasingly high-performance (DSP) & networked

Slide courtesy of Mani Srivastava®

## Why Embed Computers?

- Enablers
  - New behaviors and applications (GPS, PDA, Wii)
- Cost!
  - Intelligent Control: workaround manufacturing flaws (Auto ABS), replace antiquated controllers (Toaster), combine functions (Cell Phone)
- Remote Sensing and Control
  - Expanding Human perception and effectiveness

ATTESTED

  
Dr. S. RAMABALAN, M.E., Ph.D.,  
PRINCIPAL

E.G.S. Pillay Engineering College,  
Thethi, Nagore - 611 002.  
Nagapattinam (Dt) Tamil Nadu.

## Embedded Automotive

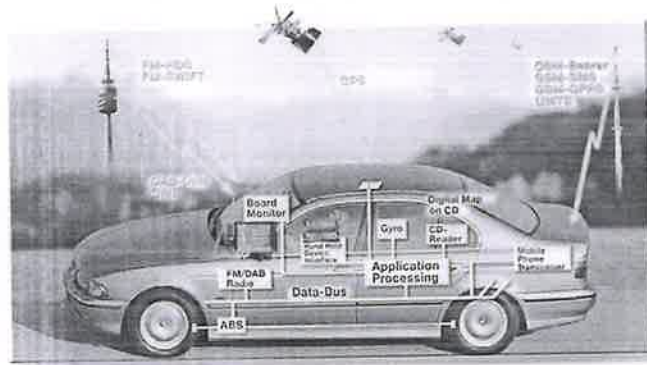

- More than 30% of the cost of a car is now in Electronics
- 90% of all innovations will be based on electronic systems

Slide courtesy of Alberto Sangiovanni-Vincentelli®

## Why do we care? Some Market Tidbits...

- Specialized devices and appliances replacing PCs
  - variety of forms: set-top boxes, fixed-screen phones, smart mobile phones, PDAs, NCs, etc.
  - In 1997, 96% of internet access devices sold in the US were PCs, by 2004, shipments far exceeded PCs
  - 2009 Tire Pressure Sensors: 60-70M/yr, Smart cards 100-200M/yr
- Traditional Products
  - dependent on computation systems
  - Modern cars: ~100 processors running complex software

Slide courtesy of Mani Srivastava®

ATTESTED

*(Signature)*  
Dr. S. RAMABALAN, M.E., Ph.D.,  
PRINCIPAL

E.G.S. Pillay Engineering College,  
Thethi, Nagore - 611 002.  
Nagapattinam (Dt) Tamil Nadu.

## Where are the CPUs?

Estimated 98% of 8 Billion CPUs produced in 2000 used for embedded apps

Where Has CS Focused?

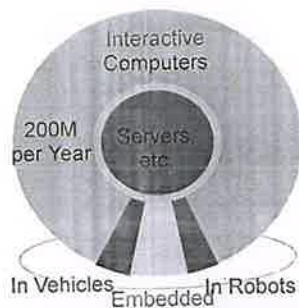

Where Are the Processors?

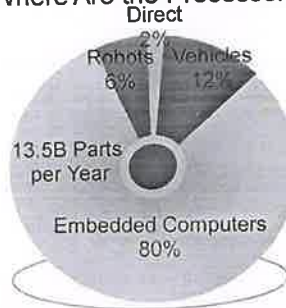

Look for the CPUs...the Opportunities Will Follow!

Source: DARPA/Intel (Tennenhouse)

## Design Issues

- **Complex Systems!**
  - How to get it working?
    - (on time, on budget)
    - Need for abstraction and design reuse
  - How to test it?
    - Unforeseen Behaviors (Air Bus!)
- **Real Time Physical Embedding**
  - Does it meet constraints?
  - Design Budgeting: Power, Size, Cost, Reliability
  - What are the exploitable design options?

ATTESTED

  
**Dr. S. RAMABALAN, M.E., Ph.D.,**  
**PRINCIPAL**

**E.G.S. Pillay Engineering College,**  
**Thethi, Nagore - 611 002.**  
**Nagapattinam (Dt) Tamil Nadu.**

# Technology

- Integrated Processors
  - Nearly free in production
- A/D, D/A, Sampling
  - Interface Analog world to cheap computing
- MEMS, NEMS, Opto-Devices
  - Miniature Direct Coupling to Real World
- Batteries, Solar Cells, Vibration Scavenging, Thermal Gradient Cell
  - Computation and Communication Power

## “Traditional” Software Embedded Systems = CPU + RTOS

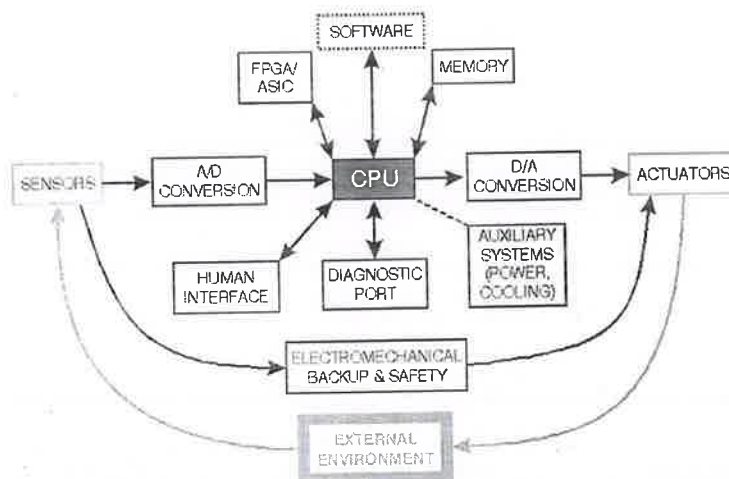

Slide courtesy of Mani Srivastava®

ATTESTED

*[Signature]*  
Dr. S. RAMABALAN, M.E., Ph.D.,  
PRINCIPAL

E.G.S. Pillay Engineering College,  
Thethi, Nagore - 611 002.  
Nagapattinam (Dt) Tamil Nadu.



## ASIC Hardware Embedded System

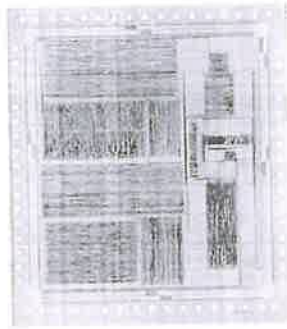

### ASIC Features

Area: 4.6 mm x 5.1 mm  
Speed: 20 MHz @ 10 Mcps  
Technology: HP 0.5  $\mu$ m  
Power: 16 mW - 120 mW  
(mode dependent) @ 20  
MHz, 3.3 V  
Avg. Acquisition Time: 10  $\mu$ s  
to 300  $\mu$ s

- A direct sequence spread spectrum (DSSS) receiver ASIC

Slide courtesy of Mani Srivastava®

## ASIC Issues

- Good:
  - High performance custom peripherals
  - Multiple heterogenous Cores
  - Integrated A/D, D/A, timers ...
  - Low Cost, High performance on-chip communication
  - Low Part Cost in Volume
- Bad:
  - Very expensive (\$5-\$75M/design)
  - Very High Risk (Several total failure points)
  - Potentially impossible to Program even if working!

ATTESTED

  
Dr. S. RAMABALAN, M.E., Ph.D.,  
PRINCIPAL

E.G.S. Pillay Engineering College,  
Thethi, Nagore - 611 002.  
Nagapattinam (Dt) Tamil Nadu.

# Reconfigurable SoC

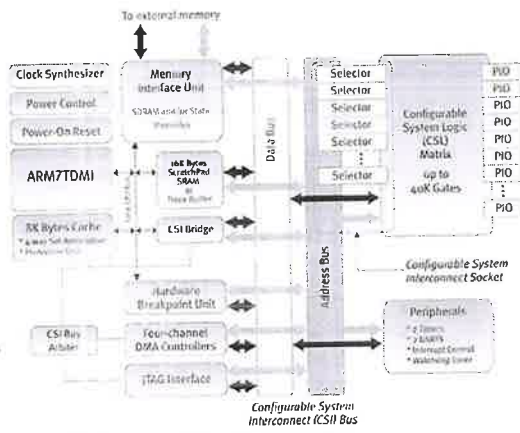

Triscend's A7 CSoC

## Other Examples

Atmel's FPSLIC (AVR + FPGA)

Altera's Nios (configurable RISC on a PLD)

TI's OMAP (ARM Cortex+ Custom GPU+ TI DSP)

Slide courtesy of Mani Srivastava®

# FPGA

FPGA advantage: performance of parallel hardware with the flexibility of software

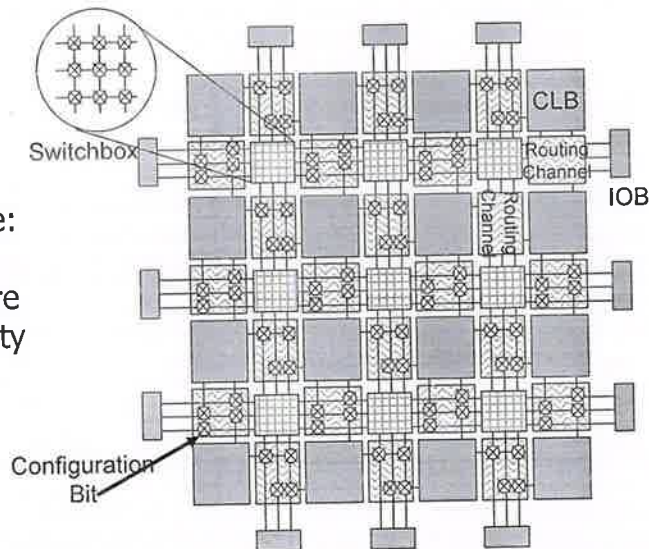

ATTESTED

Dr. S. RAMABALAN, M.E., Ph.D.,

PRINCIPAL

E.G.S. Pillay Engineering College,  
Thethi, Nagore - 611 002.  
Nagapattinam (Dt) Tamil Nadu.

## FPGA Embedded RAM

- Xilinx – Block SelectRAM
  - 18Kb dual-port RAM arranged in columns
- Altera – TriMatrix Dual-Port RAM
  - M512 – 512 x 1
  - M4K – 4096 x 1
  - M-RAM – 64K x 8

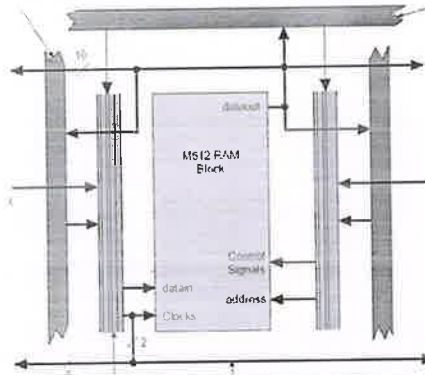

## Embedded System Design Flow

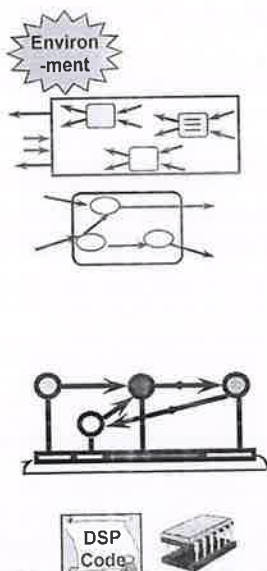

- Modeling
  - the system, and algorithms involved;
- Refining (or "partitioning")
  - the function into smaller, interacting pieces
- Test Bench Design
  - Abstractions from the Design, Communication, Storage, and Computation resources
- HW-SW partitioning: Allocation
  - (1) HW
  - (2) SW
  - Determine power and performance bounds
- Scheduling
  - When are functions executed
  - Resource Arbitration
- Mapping (Implementing)
  - (1) software, (2) Hardware,
  - (3) Coherence/Communication
- Testing/Validation
  - In situ with Design

ATTESTED

Dr. S. RAMABALAN, M.E., Ph.D.,  
PRINCIPAL

E.G.S. Pillay Engineering College,  
Thethi, Nagora - 611 002.  
Nagapattinam (Dt) Tamil Nadu.

## Many Implementation Choices

- Microprocessors
- Domain-specific processors
  - DSP
  - Network processors
  - Microcontrollers
- ASIPs
- Reconfigurable SoC
- FPGA
- GateArray
- ASIC
- Full-Custom (COTS)

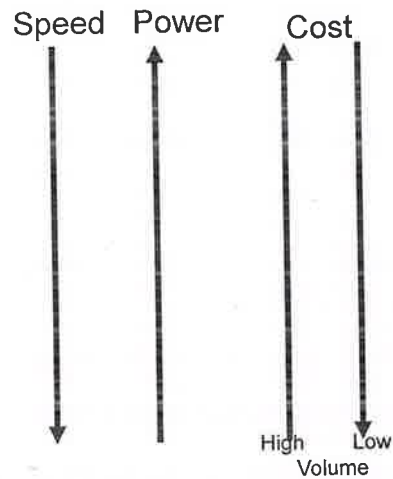

Slide courtesy of Mani Srivastava®

## Hardware vs. Software Modules

- Hardware = functionality implemented in custom architecture
- Software = functionality implemented stored program
- Key differences:
  - Configurability, Adaptability
  - Process Time Multiplexing
    - software modules time multiplexed on a processor
    - hardware modules often mapped to dedicated hardware
  - Concurrency
    - processors have serial "thread of control"
    - dedicated hardware has concurrent activity

Slide courtesy of Mani Srivastava®

ATTESTED

  
Dr. S. RAMABALAN, M.E., Ph.D.,  
PRINCIPAL

E.G.S. Pillay Engineering College,  
Thethi, Nagore - 611 002.  
Nagapattinam (Dt) Tamil Nadu.



# Hardware-Software Architecture

- A significant part of the system design problem is deciding which parts are software, and which are hardware .
- Issues:
  - Cost of development
  - System performance
  - Upgrade potential
  - Sales/Implementation Volume
  - Availability of IP
  - Development Time-Line

Slide courtesy of Mani Srivastava®

# IP-based Design

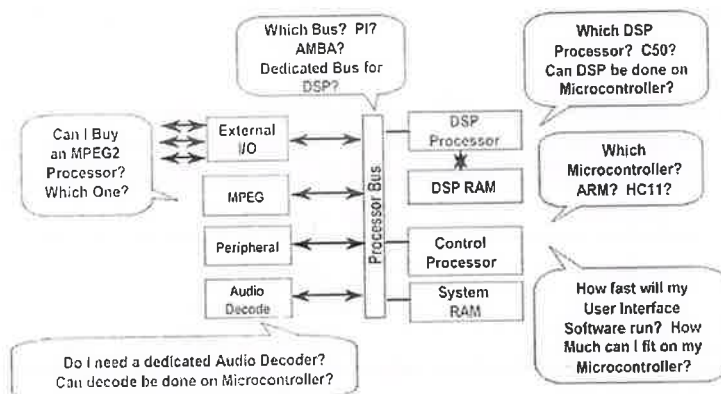

Slide courtesy of Mani Srivastava®

**ATTESTED**  
*[Signature]*  
**Dr. S. RAMABALAN, M.E., Ph.D.,**  
**PRINCIPAL**  
**E.G.S. Pillay Engineering College,**  
**Thethi, Nagore - 611 002.**  
**Nagapattinam (Dt) Tamil Nadu.**

## Map Behavior to Architecture

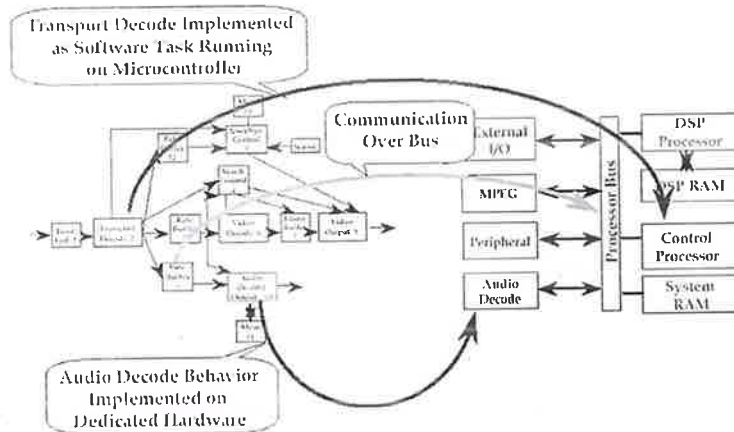

Slide courtesy of Mani Srivastava®

## Metrics / Models / Abstractions and Systematic Analysis

To make progress, we need objective means to evaluate heterogeneous collections of components, to test and validate correct operation and models to abstract system complexity.

- Models of Computation
  - Provide metrics on component and system performance
    - Time, Throughput, Power?
  - Abstract models as bounds on system behavior
    - Provable or at least Simulation bound on system correctness
  - Unfortunately– no complete, encompassing, provable model exists
    - Lots of small provable sub-models: FSM, eFSM, SDL, Kahn Processes
    - Lots of encompassing but undecidable models: RT-FSM, General Modal Logic
- In search of set of generally useful abstractions
  - Embedded Systems a bit like software compilers in Lisp/Fortran era

**ATTESTED**  
  
**Dr. S. RAMABALAN, M.E., Ph.D.,**  
**PRINCIPAL**  
**E.G.S. Pillay Engineering College,**  
**Thethi, Nagore - 611 002.**  
**Nagapattinam (Dt) Tamil Nadu.**

# EMBEDDED SYSTEM

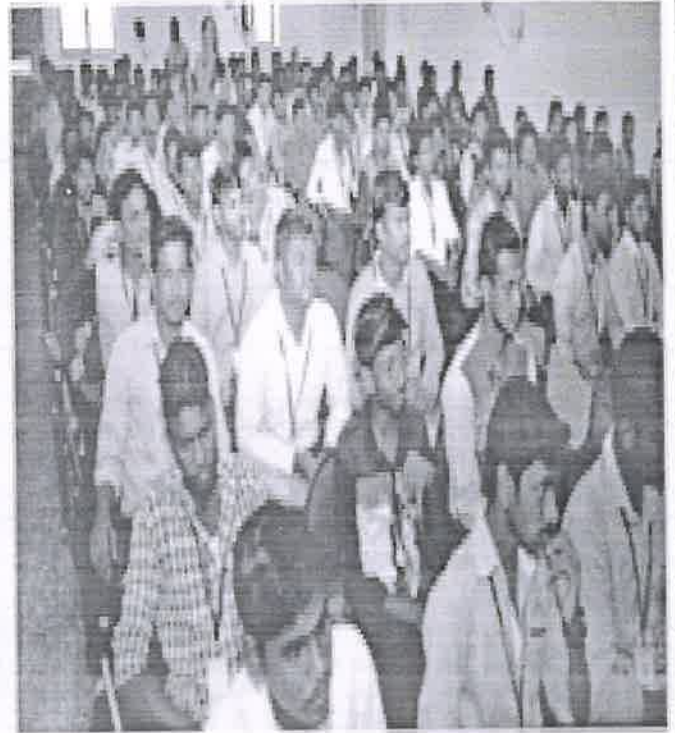

**ATTESTED**

**Dr. S. RAMABALAN, M.E., Ph.D.,  
PRINCIPAL**

**E.G.S. Pillay Engineering College,  
Thethi, Nagore - 611 002.  
Nagapattinam (Dt) Tamil Nadu.**

## PARTICIPANT FEEDBACK FORM

Program : One day Seminar  
Title : Embedded system  
Date : 02.04.2019  
Coordinators : Mr.S. Sivamani  
Organizer : Department of Electrical and Electronics Engineering  
Institution : E.G.S. Pillay engineering College

**Instruction:** Please indicate your level of agreement with the statements listed below in scores ranging from 5-1

| S.No | Parameters   | Strongly Agree (5) | Agree (4) | Neutral (3) | Disagree (2) | Strongly Disagree (1) |
|------|--|--------------------|-----------|-------------|--------------|-----------------------|
| 1    | The objectives of the course were clearly defined  |                    |           |             |              |                       |
| 2    | Participation and interaction were encouraged  |                    |           |             |              |                       |
| 3    | Topics covered were relevant to the programme  |                    |           |             |              |                       |
| 4    | The content was organized and easy to follow   |                    |           |             |              |                       |
| 5    | The content is easy to understand useful to analyze  |                    |           |             |              |                       |
| 6    | This course experience will be useful in my teaching/ research                                 |                    |           |             |              |                       |
| 7    | Lectures were very informative on current state of art design and useful to apply the concepts |                    |           |             |              |                       |
| 8    | The programme objectives were met  |                    |           |             |              |                       |
| 9    | Time allotted for topics were sufficient   |                    |           |             |              |                       |
| 10   | The learning environment and facilities were adequate and comfortable                          |                    |           |             |              |                       |

**Overall rating:** Excellent (E) / Good (G) / Satisfactory(S) / Poor (P)

**ATTESTED**

  
**Dr. S. RAMABALAN, M.E., Ph.D.,  
PRINCIPAL**

**E.G.S. Pillay Engineering College,  
Thethi, Nagore - 611 002.  
Nagapattinam (Dt) Tamil Nadu.**



|    |  |
|----|--|
| 11 | What did you like most about this programme?     |
| 12 | What are the things to be added for improvement? |
| 13 | Any more suggestions to improve the programme    |

**Thanks for your valuable feedback**

**ATTESTED**  
  
**Dr. S. RAMABALAN, M.E., Ph.D.,**  
**PRINCIPAL**  
**E.G.S. Pillay Engineering College,**  
**Thethi, Nagore - 611 002.**  
**Nagapattinam (Dt) Tamil Nadu.**

## PARTICIPANT FEEDBACK FORM

Program : One day Seminar  
 Title : Embedded system  
 Date : 02.04.2019  
 Coordinators : Mr.S. Sivamani  
 Organizer : Department of Electrical and Electronics Engineering  
 Institution : E.G.S. Pillay engineering College

**Instruction:** Please indicate your level of agreement with the statements listed below in scores ranging from 5-1

| S.No | Parameters   | Strongly Agree (5) | Agree (4) | Neutral (3) | Disagree (2) | Strongly Disagree (1) |
|------|--|--------------------|-----------|-------------|--------------|-----------------------|
| 1    | The objectives of the course were clearly defined  |                    |           |             |              |                       |
| 2    | Participation and interaction were encouraged  |                    |           |             |              |                       |
| 3    | Topics covered were relevant to the programme  |                    |           |             |              |                       |
| 4    | The content was organized and easy to follow   |                    |           |             |              |                       |
| 5    | The content is easy to understand useful to analyze  |                    |           |             |              |                       |
| 6    | This course experience will be useful in my teaching/ research                                 |                    |           |             |              |                       |
| 7    | Lectures were very informative on current state of art design and useful to apply the concepts |                    |           |             |              |                       |
| 8    | The programme objectives were met  |                    |           |             |              |                       |
| 9    | Time allotted for topics were sufficient   |                    |           |             |              |                       |
| 10   | The learning environment and facilities were adequate and comfortable                          |                    |           |             |              |                       |

**Overall rating:** Excellent (E) / Good (G) / Satisfactory(S) / Poor (P)

**ATTESTED**

  
**Dr. S. RAMABALAN, M.E., Ph.D.,**  
**PRINCIPAL**

**E.G.S. Pillay Engineering College,**  
**Thethi, Nagore - 611 002.**  
**Nagapattinam (Dt) Tamil Nadu.**

|    |  |
|----|--|
| 11 | What did you like most about this programme?     |
| 12 | What are the things to be added for improvement? |
| 13 | Any more suggestions to improve the programme    |

**Thanks for your valuable feedback**

**ATTESTED**

  
**Dr. S. RAMABALAN, M.E., Ph.D.,**  
**PRINCIPAL**  
**E.G.S. Pillay Engineering College,**  
**Thethi, Nagore - 611 002.**  
**Nagapattinam (Dt) Tamil Nadu.**

## PARTICIPANT FEEDBACK FORM

Program : One day Seminar  
Title : Embedded system  
Date : **02.04.2019**  
Coordinators : Mr.S. Sivamani  
Organizer : Department of Electrical and Electronics Engineering  
Institution : E.G.S. Pillay engineering College

**Instruction:** Please indicate your level of agreement with the statements listed below in scores ranging from 5-1

| S.No | Parameters   | Strongly Agree (5) | Agree (4) | Neutral (3) | Disagree (2) | Strongly Disagree (1) |
|------|--|--------------------|-----------|-------------|--------------|-----------------------|
| 1    | The objectives of the course were clearly defined  |                    |           |             |              |                       |
| 2    | Participation and interaction were encouraged  |                    |           |             |              |                       |
| 3    | Topics covered were relevant to the programme  |                    |           |             |              |                       |
| 4    | The content was organized and easy to follow   |                    |           |             |              |                       |
| 5    | The content is easy to understand useful to analyze  |                    |           |             |              |                       |
| 6    | This course experience will be useful in my teaching/ research                                 |                    |           |             |              |                       |
| 7    | Lectures were very informative on current state of art design and useful to apply the concepts |                    |           |             |              |                       |
| 8    | The programme objectives were met  |                    |           |             |              |                       |
| 9    | Time allotted for topics were sufficient   |                    |           |             |              |                       |
| 10   | The learning environment and facilities were adequate and comfortable                          |                    |           |             |              |                       |

**Overall rating:** Excellent (E) / Good (G) / Satisfactory(S) / Poor (P)

**ATTESTED**

  
**Dr. S. RAMABALAN, M.E., Ph.D.,**  
**PRINCIPAL**  
**E.G.S. Pillay Engineering College,**  
**Thethi, Nagore - 611 002.**  
**Nagapattinam (Dt) Tamil Nadu.**



|    |  |
|----|--|
| 11 | What did you like most about this programme?     |
| 12 | What are the things to be added for improvement? |
| 13 | Any more suggestions to improve the programme    |

**Thanks for your valuable feedback**

**ATTESTED**

  
**Dr. S. RAMABALAN, M.E., Ph.D.,**  
**PRINCIPAL**  
E.G.S. Pillay Engineering College,  
Thethi, Nagore - 611 002.  
Nagapattinam (Dt) Tamil Nadu.

## PARTICIPANT FEEDBACK FORM

Program : One day Seminar  
 Title : Embedded system  
 Date : 02.04.2019  
 Coordinators : Mr.S. Sivamani  
 Organizer : Department of Electrical and Electronics Engineering  
 Institution : E.G.S. Pillay engineering College

**Instruction:** Please indicate your level of agreement with the statements listed below in scores ranging from 5-1

| S.No | Parameters   | Strongly Agree (5) | Agree (4) | Neutral (3) | Disagree (2) | Strongly Disagree (1) |
|------|--|--------------------|-----------|-------------|--------------|-----------------------|
| 1    | The objectives of the course were clearly defined  |                    |           |             |              |                       |
| 2    | Participation and interaction were encouraged  |                    |           |             |              |                       |
| 3    | Topics covered were relevant to the programme  |                    |           |             |              |                       |
| 4    | The content was organized and easy to follow   |                    |           |             |              |                       |
| 5    | The content is easy to understand useful to analyze  |                    |           |             |              |                       |
| 6    | This course experience will be useful in my teaching/ research                                 |                    |           |             |              |                       |
| 7    | Lectures were very informative on current state of art design and useful to apply the concepts |                    |           |             |              |                       |
| 8    | The programme objectives were met  |                    |           |             |              |                       |
| 9    | Time allotted for topics were sufficient   |                    |           |             |              |                       |
| 10   | The learning environment and facilities were adequate and comfortable                          |                    |           |             |              |                       |

**Overall rating:** Excellent (E) / Good (G) / Satisfactory(S) / Poor (P)

**ATTESTED**  
  
**Dr. S. RAMABALAN, M.E., Ph.D.,**  
**PRINCIPAL**  
 E.G.S. Pillay Engineering College,  
 Thethi, Nagore - 611 002.  
 Nagapattinam (Dt) Tamil Nadu.

|    |  |
|----|--|
| 11 | What did you like most about this programme?     |
| 12 | What are the things to be added for improvement? |
| 13 | Any more suggestions to improve the programme    |

Thanks for your valuable feedback

ATTESTED

  
Dr. S. RAMABALAN, M.E., Ph.D.,  
PRINCIPAL

E.G.S. Pillay Engineering College,  
Thethi, Nagore - 611 002.  
Nagapattinam (Dt) Tamil Nadu.

## PARTICIPANT FEEDBACK FORM

Program : One day Seminar  
 Title : Embedded system  
 Date : 02.04.2019  
 Coordinators : Mr.S. Sivamani  
 Organizer : Department of Electrical and Electronics Engineering  
 Institution : E.G.S. Pillay engineering College

**Instruction:** Please indicate your level of agreement with the statements listed below in scores ranging from 5-1

| S.No | Parameters   | Strongly Agree (5) | Agree (4) | Neutral (3) | Disagree (2) | Strongly Disagree (1) |
|------|--|--------------------|-----------|-------------|--------------|-----------------------|
| 1    | The objectives of the course were clearly defined  |                    |           |             |              |                       |
| 2    | Participation and interaction were encouraged  |                    |           |             |              |                       |
| 3    | Topics covered were relevant to the programme  |                    |           |             |              |                       |
| 4    | The content was organized and easy to follow   |                    |           |             |              |                       |
| 5    | The content is easy to understand useful to analyze  |                    |           |             |              |                       |
| 6    | This course experience will be useful in my teaching/ research                                 |                    |           |             |              |                       |
| 7    | Lectures were very informative on current state of art design and useful to apply the concepts |                    |           |             |              |                       |
| 8    | The programme objectives were met  |                    |           |             |              |                       |
| 9    | Time allotted for topics were sufficient   |                    |           |             |              |                       |
| 10   | The learning environment and facilities were adequate and comfortable                          |                    |           |             |              |                       |

**Overall rating:** Excellent (E) / Good (G) / Satisfactory(S) / Poor (P)

**ATTESTED**

  
**Dr. S. RAMABALAN, M.E., Ph.D.,**  
**PRINCIPAL**  
 E.G.S. Pillay Engineering College,  
 Thethi, Nagore - 611 002.  
 Nagapattinam (Dt) Tamil Nadu.

|    |  |
|----|--|
| 11 | What did you like most about this programme?     |
| 12 | What are the things to be added for improvement? |
| 13 | Any more suggestions to improve the programme    |

**Thanks for your valuable feedback**

**ATTESTED**



**Dr. S. RAMABALAN, M.E., Ph.D.,  
PRINCIPAL**

**E.G.S. Pillay Engineering College,  
Thethi, Nagore - 611 002.  
Nagapattinam (Dt) Tamil Nadu.**



## PARTICIPANT FEEDBACK FORM

Program : One day Seminar  
 Title : Embedded system  
 Date : 02.04.2019  
 Coordinators : Mr.S. Sivamani  
 Organizer : Department of Electrical and Electronics Engineering  
 Institution : E.G.S. Pillay engineering College

**Instruction:** Please indicate your level of agreement with the statements listed below in scores ranging from 5-1

| S.No | Parameters   | Strongly Agree (5) | Agree (4) | Neutral (3) | Disagree (2) | Strongly Disagree (1) |
|------|--|--------------------|-----------|-------------|--------------|-----------------------|
| 1    | The objectives of the course were clearly defined  |                    |           |             |              |                       |
| 2    | Participation and interaction were encouraged  |                    |           |             |              |                       |
| 3    | Topics covered were relevant to the programme  |                    |           |             |              |                       |
| 4    | The content was organized and easy to follow   |                    |           |             |              |                       |
| 5    | The content is easy to understand useful to analyze  |                    |           |             |              |                       |
| 6    | This course experience will be useful in my teaching/ research                                 |                    |           |             |              |                       |
| 7    | Lectures were very informative on current state of art design and useful to apply the concepts |                    |           |             |              |                       |
| 8    | The programme objectives were met  |                    |           |             |              |                       |
| 9    | Time allotted for topics were sufficient   |                    |           |             |              |                       |
| 10   | The learning environment and facilities were adequate and comfortable                          |                    |           |             |              |                       |

**Overall rating:** Excellent (E) / Good (G) / Satisfactory(S) / Poor (P)

**ATTESTED**

  
**Dr. S. RAMABALAN, M.E., Ph.D.,**  
**PRINCIPAL**  
**E.G.S. Pillay Engineering College,**  
**Thethi, Nagore - 611 002.**  
**Nagapattinam (Dt) Tamil Nadu.**

|    |  |
|----|--|
| 11 | What did you like most about this programme?     |
| 12 | What are the things to be added for improvement? |
| 13 | Any more suggestions to improve the programme    |

**Thanks for your valuable feedback**

**ATTESTED**

  
**Dr. S. RAMABALAN, M.E., Ph.D.,**  
**PRINCIPAL**  
**E.G.S. Pillay Engineering College,**  
**Thethi, Nagore - 611 002.**  
**Nagapattinam (Dt) Tamil Nadu.**



# E.G.S PILLAY ENGINEERING COLLEGE (AUTONOMOUS)



**NAGAPATTINAM - 611002**

Accredited by NAAC with 'A' Grade | Accredited by NBA (EEE, MECH, CSE)  
Approved by AICTE - New Delhi and Affiliated to Anna University - Chennai



one days Seminar on

**EMBEDDED SYSTEM”**

Organized by

*Department of Electrical & Electronics Engineering*



*Certificate*



This is to certify that Mr. / Ms. / Mrs. K.Nandakumar

of E.G.S.PILLAY.ENGG.COLLEGE has attended one day seminar on  
**EMBEDDED SYSTEM** on 02<sup>nd</sup> April 2019.

**CONVENER**

ATTESTED

**Dr. S. RAMABALAN, M.E., Ph.D.,  
PRINCIPAL**

**E.G.S. Pillay Engineering College,  
Thethi, Nagore - 611 002,  
Nagapattinam (Dt) Tamil Nadu.**

**PRINCIPAL**



(Approved by AICTE, Affiliated to Anna University (Autonomous))  
(Accredited by NAAC with "A" Grade)  
(Accredited by NBA)



*Organized by*

*Computer Engineers Association,*

*Department of CSE*

*E. G. S Pillay Engineering College,*

*Nagapattinam – 611 002*

*Tamil Nadu.*

*Resource Person*

*P. Anandraj M.E.,*

*Assistant Professor / CSE*

*J. Noorul-Ameen M.E.,*

*Assistant Professor / CSE*

*E. G. S Pillay Engineering College,*

*Nagapattinam – 611 002*

**E.G.S. Pillay Engineering College (Autonomous), Nagapattinam-611002.**

**Two Days Hands on Workshop on Adobe Photoshop & Pagemaker**

**Date: 06/09/2018 & 07/09/2018**

## **CONTENTS**

1. Circular
2. Requisition Letter
3. Participants Attendance
4. PO-CO Mapping
5. Material
6. Sample Feedback
7. Sample Photos
8. Certificates

**ATTESTED**

**ATTESTED**

**Dr. S. RAMABALAN, M.E., Ph.D.,**  
**PRINCIPAL**  
**E.G.S. Pillay Engineering College,**  
**Therhi, Nagore - 611 002.**  
**Nagapattinam (Dt) Tamil Nadu.**



E.G.S. PILLAY ENGINEERING COLLEGE (AUTONOMOUS), NAGAPATTINAM  
DEPARTMENT OF COMPUTER SCIENCE AND ENGINEERING

CIRCULAR

EGSPEEC/CSE/2018/Workshop-NT28.08.2018

Greetings from Computer Engineers Association, Department of CSE!!

We are going to organize "Two Days Hands on Workshop on Adobe Photoshop & Pagemaker" on 06/09/2018 and 07/09/2018. In this regard all non teaching staff members of our college are requested to attend this workshop.



Head of the Department

Dr. M. CHINNADURAI, M.E., Ph.D.,  
Professor & Head  
Department of CSE  
E.G.S. Pillay Engineering College,  
Nagapattinam - 611 002.

CC to: The Secretary, The Principal, All Hods, PED, COE, Account Office, Office File.

ATTESTED  
  
Dr. S. RAMABALAN, M.E., Ph.D., D.,  
PRINCIPAL  
E.G.S. Pillay Engineering College,  
Thethi, Nagore - 611 002.  
Nagapattinam (D), Tamil Nadu.

E.G.S PILLAY ENGINEERING COLLEGE, NAGAPATTINAM

DEPARTMENT OF CSE

(Approved by AICTE, Affiliated to Anna University)

(Accredited by NBA) (Accredited by NAAC with "A" Grade)

Two days "Hands on workshop on Adobe Photoshop & Pagemaker"

ATTENDANCE

| S. No | Name                   | Designation           | Department         | 06/09/2018     | 07/09/2018     |
|-------|------------------------|-----------------------|--------------------|----------------|----------------|
| 1.    | P.MEERABAI             | Office Superintendent | Accounts Office    | P.Meerabai     | P.Meerabai     |
| 2.    | J.KASTHURI             | Clerk                 | Accounts Office    | J.Kasthuri     | J.Kasthuri     |
| 3.    | K.MUTHUKUMARASMI       | Accountant            | Accounts Office    | K.Muthu        | K.Muthu        |
| 4.    | D.PRINCEAYYA           | Office Superintendent | Principal Office   | D.Princey      | D.Princey      |
| 5.    | S.VENKATESAN           | Lab Assistant         | Mech               | S.Venkatesan   | S.Venkatesan   |
| 6.    | M.G.CHELLAPPA          | Lab Assistant         | Mech               | M.G.Chellappa  | M.G.Chellappa  |
| 7.    | V.RAMU                 | Lab Assistant         | Mech               | V.Ramu         | V.Ramu         |
| 8.    | S.SAKTHIVEL            | Lab Assistant         | Mech               | S.Sakthivel    | S.Sakthivel    |
| 9.    | R.JAIKUMAR             | Lab Assistant         | MCA                | R.Jaikumar     | R.Jaikumar     |
| 10.   | EMMANUEL               | Lab Assistant         | MCA                | Emmanuel       | Emmanuel       |
| 11.   | P.MUTHUNAYAGAM         | Lab Assistant         | IT                 | P.Muthu        | P.Muthu        |
| 12.   | K.VIGNESH              | Lab Assistant         | CSE                | K.Vignesh      | K.Vignesh      |
| 13.   | S.ARUNA                | Lab Assistant         | CSE                | S.Aruna        | S.Aruna        |
| 14.   | P.SUHASHINI            | Lab Assistant         | CSE                | P.Suhashini    | P.Suhashini    |
| 15.   | K.RAJU                 | Lab assistant         | ECE                | K.Raju         | K.Raju         |
| 16.   | V.G.SUDHARSANA BALAJEE | Lab Assistant         | ECE                | V.G.Sudharsana | V.G.Sudharsana |
| 17.   | B.NIRMAL DEV           | Lab assistant         | ECE                | B.Nirmal       | B.Nirmal       |
| 18.   | S.KALAIVANI            | Lab assistant         | ECE                | S.Kalaivani    | S.Kalaivani    |
| 19.   | V.KARTHIKEYAN          | Lab Assistant         | ECE                | V.Karthikeyan  | V.Karthikeyan  |
| 20.   | S.DURGA                | Lab assistant         | EEE                | S.Durga        | S.Durga        |
| 21.   | V.RAMAMOORTHY          | Lab assistant         | CIVIL              | V.Ramamoorthy  | V.Ramamoorthy  |
| 22.   | G.DURGA                | Lab assistant         | CIVIL              | G.Durga        | G.Durga        |
| 23.   | V.JANANI               | Lab assistant         | CIVIL              | V.Janani       | V.Janani       |
| 24.   | MATHURABASHINI.R       | Assistant librarian   | Library            | M.Mathu        | M.Mathu        |
| 25.   | SUMATHI. R             | Assistant librarian   | Library            | S.Sumathi      | S.Sumathi      |
| 26.   | MURUGANANDAM G         | Assistant librarian   | Library            | M.Murugan      | M.Murugan      |
| 27.   | D.VELAVAN              | Physical Director     | Physical Education | D.Velavan      | D.Velavan      |
| 28.   | VIJAYASANKAR.S         | Technical Assistant   | SAH                | Vijayar        | Vijayar        |

COORDINATOR

ATTESTED

DRS. RAMABALAN, M.E., Ph.D.,  
PRINCIPAL  
E.G.S. Pillay Engineering College,  
Theni, Nagore - 611 002.  
Nagapattinam (Dt) Tamil Nadu.

HOD

Dr. M. CHINNADURAI, M.E., Ph.D.,  
Professor & Head  
Department of CSE  
E.G.S. Pillay Engineering College,  
Nagapattinam - 611 002.

**E.G.S PILLAY ENGINEERING COLLEGE, NAGAPATTINAM**

**DEPARTMENT OF CSE**

(Approved by AICTE, Affiliated to Anna University)

(Accredited by NBA) (Accredited by NAAC with "A" Grade)

Two days "Hands on workshop on Adobe Photoshop & Pagemaker"

**COURSE OUTCOMES**

At the end of this workshop, attendees can able to

| CO Number | Competency   | Cognitive level |
|-----------|--|-----------------|
| CO1       | Develop and edit documents using Pagemaker.                        | Apply           |
| CO2       | Design and Develop desktop publishing application using pagemaker. | Apply           |
| CO3       | Prepare brochure using Photoshop                                   | Apply           |
| CO4       | Perform image editing using Photoshop                              | Apply           |

| S. No | Name                      | Designation           | Department       | CO1 | CO2 | CO3 | CO4 |
|-------|---------------------------|-----------------------|------------------|-----|-----|-----|-----|
| 1.    | P.MEERABAI                | Office Superintendent | Accounts Office  | 3   | 3   | 3   | 3   |
| 2.    | J.KASTHURI                | Clerk                 | Accounts Office  | 3   | 3   | 3   | 3   |
| 3.    | K.MUTHUKUMARASMI          | Accountant            | Accounts Office  | 3   | 2   | 2   | 2   |
| 4.    | D.PRINCEAYYA              | Office Superintendent | Principal Office | 3   | 3   | 3   | 3   |
| 5.    | S.VENKATESAN              | Lab Assistant         | Mech             | 3   | 3   | 3   | 3   |
| 6.    | M.G.CHELLAPPA             | Lab Assistant         | Mech             | 2   | 2   | 2   | 2   |
| 7.    | V.RAMU                    | Lab Assistant         | Mech             | 3   | 3   | 3   | 3   |
| 8.    | S.SAKTHIVEL               | Lab Assistant         | Mech             | 3   | 3   | 3   | 3   |
| 9.    | R.JAIKUMAR                | Lab Assistant         | MCA              | 3   | 3   | 3   | 3   |
| 10.   | EMMANUEL                  | Lab Assistant         | MCA              | 3   | 3   | 3   | 3   |
| 11.   | P.MUTHUNAYAGAM            | Lab Assistant         | IT               | 3   | 3   | 3   | 3   |
| 12.   | K.VIGNESH                 | Lab Assistant         | CSE              | 3   | 3   | 3   | 3   |
| 13.   | S.ARUNA                   | Lab Assistant         | CSE              | 3   | 3   | 3   | 3   |
| 14.   | P.SUHASHINI               | Lab Assistant         | CSE              | 3   | 3   | 3   | 3   |
| 15.   | K.RAJU                    | Lab assistant         | ECE              | 2   | 2   | 2   | 2   |
| 16.   | V.G.SUDHARSANA<br>BALAJEE | Lab Assistant         | ECE              | 2   | 2   | 2   | 2   |
| 17.   | B.NIRMAL DEV              | Lab assistant         | ECE              | 3   | 3   | 3   | 3   |
| 18.   | S.KALAIVANI               | Lab assistant         | ECE              | 2   | 2   | 2   | 2   |
| 19.   | V.KARTHIKEYAN             | Lab Assistant         | ECE              | 3   | 3   | 3   | 3   |
| 20.   | S.DURGA                   | Lab assistant         | EEE              | 3   | 3   | 3   | 3   |
| 21.   | V.RAMAMOORTHY             | Lab assistant         | CIVIL            | 3   | 3   | 3   | 3   |
| 22.   | G.DURGA                   | Lab assistant         | CIVIL            | 3   | 3   | 3   | 3   |

  
**ATTESTED**  
**Dr. S. RAMABALAN, M.E., Ph.D.,**  
**PRINCIPAL**  
 E.G.S Pillay Engineering College,  
 Thiruv. Nagar - 611 002,  
 Nagapattinam (Tamil Nadu)

|                         |                  |                     |                    |           |           |           |           |
|-------------------------|------------------|---------------------|--------------------|-----------|-----------|-----------|-----------|
| 23.                     | V.JANANI         | Lab assistant       | CIVIL              | 2         | 2         | 2         | 2         |
| 24.                     | MATHURABASHINI.R | Assistant librarian | Library            | 3         | 3         | 3         | 3         |
| 25.                     | SUMATHI. R       | Assistant librarian | Library            | 3         | 3         | 3         | 3         |
| 26.                     | MURUGANANDAM G   | Assistant librarian | Library            | 3         | 3         | 3         | 3         |
| 27.                     | D.VELAVAN        | Physical Director   | Physical Education | 3         | 3         | 3         | 3         |
| 28.                     | VIJAYASANKAR.S   | Technical Assistant | SAH                | 3         | 3         | 3         | 3         |
| <b>TOTAL</b>            |                  |                     |                    | <b>79</b> | <b>78</b> | <b>78</b> | <b>78</b> |
| <b>ATTAINMENT</b>       |                  |                     |                    | <b>94</b> | <b>93</b> | <b>93</b> | <b>93</b> |
| <b>ATTAINMENT LEVEL</b> |                  |                     |                    | <b>3</b>  | <b>3</b>  | <b>3</b>  | <b>3</b>  |

**Attainment Level 1,2,3**

**Attainment Level 1: >70%**

**Attainment Level 2: >80%**

**Attainment Level 3: >90%**

  
**Event Coordinator**

  
**HOD**

Dr. M. CHINNADURAI, M.E., Ph.D.,  
Professor & Head  
Department of CSE  
E.G.S. Pillay Engineering College,  
Nagapattinam - 611 002.

**ATTESTED**  
  
**Dr. S. RAMABALAN, M.E., Ph.D.,**  
**PRINCIPAL**  
**E.G.S. Pillay Engineering College,**  
**Thethi, Nagore - 611 002,**  
**Nagapattinam (Dt) Tamil Nadu.**



**E.G.S. PILLAY ENGINEERING COLLEGE(AUTONOMOUS), NAGAPATTINAM**  
**DEPARTMENT OF CSE**

Two days "Hands on workshop on Adobe Photoshop & Pagemaker"

Date: 06/09/2018 & 07/09/2018

**Feedback Form**

Name: **P. HEERABA I**

Designation: **Office Superintendent**

Department: **Accounts Office**

At the end of this training program, attendees can able to

| S.NO | COURSE OUTCOME   | COGNITIVE LEVEL | RATINGS      |       |         |          |
|------|--|-----------------|--------------|-------|---------|----------|
|      |  |                 | Highly Agree | Agree | Neutral | Disagree |
| CO1  | Develop and edit documents using Pagemaker.                        | Apply           |              | ✓     |         |          |
| CO2  | Design and Develop desktop publishing application using pagemaker. | Apply           |              |       |         | ✓        |
| CO3  | Prepare brochure using Photoshop                                   | Apply           | ✓            |       |         |          |
| CO4  | Perform image editing using Photoshop                              | Apply           |              |       | ✓       |          |

**ATTESTED**

**DR. S. RAMABALAN, M.E., PH.D.**  
**DR. S. R. PRINCIPAL**

**E.G.S. Pillay Engineering College**  
**E. Thethi, Nagore - 611 002**  
**Nagapattinam (Dt) Tamil Nadu.**  
**Nagapattinam (Dt) Tamil Nadu.**

*P. Heeraba I*

Signature of the Attendee



**E.G.S. PILLAY ENGINEERING COLLEGE(AUTONOMOUS), NAGAPATTINAM  
DEPARTMENT OF CSE**

Two days "Hands on workshop on Adobe Photoshop & Pagemaker"  
Date: 06/09/2018 & 07/09/2018

**Feedback Form**

Name: **K. VIGNESH**  
Designation: **Lab Assistant**  
Department: **CSE**

At the end of this training program, attendees can able to

| S.NO | COURSE OUTCOME   | COGNITIVE LEVEL | RATINGS      |       |         |          |
|------|--|-----------------|--------------|-------|---------|----------|
|      |  |                 | Highly Agree | Agree | Neutral | Disagree |
| CO1  | Develop and edit documents using Pagemaker.                        | Apply           |              |       | ✓       |          |
| CO2  | Design and Develop desktop publishing application using pagemaker. | Apply           |              | ✓     |         |          |
| CO3  | Prepare brochure using Photoshop                                   | Apply           |              |       | ✓       |          |
| CO4  | Perform image editing using Photoshop                              | Apply           | ✓            |       |         |          |

**ATTESTED**

  
**DR. S. RAMABALAN, M.EE, PH.D.,  
PRINCIPAL**

**E.G.S.Pillay Engineering College,  
Tretti, Nagorb - 611 002,  
Nagapattinam (Dt), Tamil Nadu.**

**K. Vignesh**  
Signature of the Attendee

**E.G.S. PILLAY ENGINEERING COLLEGE (AUTONOMOUS), NAGAPATTINAM**

**DEPARTMENT OF CSE**

**Two Days Hands on Workshop on Adobe Photoshop & Pagemaker**

**Synopsis of the seminar**

**Date: 06/09/2018 & 07/09/2018**

Computer Engineers Association - Department of Computer Science and Engineering conducted Two days "Hands on workshop on Adobe Photoshop & Pagemaker".

- Coordinators: Prof P. Anandraj and Prof J. Noorul Ameen
- Convenor: Prof Dr. M.Chinnadurai/ Head of the Department / CSE

Inaugurated and supported by our beloved Secretary Mr S.Pamesvaran,, Dr. S. Ramabalan Principal, Dr. M.Chinnadurai, Head of the Department and Faculty Members of CSE department .

Drived by Prof P.Anandraj, and Prof. J.Noorul Ameen, Assistant Professor, Department of CSE.

Non teaching staffs from our engineering college are actively participated.

**Outcome of the workshop:**

1. Develop and edit documents using Pagemaker.
2. Design and Develop desktop publishing application using pagemaker.
3. Prepare brochure using Photoshop
4. Perform image editing using Photoshop

We thank our Management, Principal sir, and Hod sir for giving permission to conduct this workshop successfully.

We extend our thanks to our department eminent professors who are all contributed to conduct this workshop successfully.

We thank our System Admin , and Supporting staff of our Department for making necessary lab arrangements.

**ATTESTED**  
  
**Dr. S. RAMABALAN, M.E., Ph.D.,**  
**PRINCIPAL**  
**E.G.S. Pillay Engineering College,**  
**Thethi, Nagapattinam - 611022.**  
**Nagapattinam (Dt. Tamil Nadu).**

# E.G.S. PILLAY ENGINEERING COLLEGE (AUTONOMOUS)

Accredited by NBA (B.E-CSE, ECE, EEE, Mech, Civil/3. Tech-II)

Affiliated to Anna University, Chennai | Approved by AICTE, New Delhi



Accredited by NAAC with Grade 'A'

An ISO 9001:2015 Certified Institution | Recognised by UGC 2(f) & 12(B)

[principal@egspec.org](mailto:principal@egspec.org) | [enquires@egspec.org](mailto:enquires@egspec.org)

+91-4365-251112 | +91-4365-251114

Counselling Code : 3806

Old Nagore Road, Thethi, Nagapattinam - 611002, Tamil Nadu NIRF Engineering Ranking top 200 in India

## DEPARTMENT OF COMPUTER SCIENCE AND ENGINEERING

### CERTIFICATE OF COMPLETION

This is to certify that **B.NIRMAL DEV / ECE** has successfully completed "Two days Hands on workshop on Adobe Photoshop & Pagemaker" Conducted by Department of Computer Science and Engineering, E.G.S Pillay Engineering College, Nagapattinam from 06/09/2018 to 07/09/2018

  
**P. Anandraj**  
Coordinator

  
**J. Noorul Anis**  
Coordinator

**ATTESTED**  
  
**Dr. S. RAMABALAN, M.Phil**  
PRINCIPAL

  
**Dr. S. Ramabalan**  
Principal

  
**Dr. S. Ramabalan**  
Principal

**E.G.S. Pillay Engineering College,**  
Thethi, Nagore - 611 002,  
Nagapattinam (Dt) Tamil Nadu.



# E.G.S. PILLAY ENGINEERING COLLEGE (AUTONOMOUS)

Accredited by NBA|B.E-CSE,ECE,EEE,Mech,Civil|B.Tech-II|

Affiliated to Anna University, Chennai | Approved by AICTE, New Delhi



Accredited by NAAC with Grade 'A'

An ISO 9001:2015 Certified Institution | Recognised by UGC 2(f) & 12(B)

[principal@egspec.org](mailto:principal@egspec.org) | [enquiries@egspec.org](mailto:enquiries@egspec.org)

+91-4365-251112 | +91-4365-251114

Counselling Code: 3806

Old Nagore Road, Thethi, Nagapattinam - 611002, Tamil Nadu NIRF Engineering Ranking Top 200 in India

## DEPARTMENT OF COMPUTER SCIENCE AND ENGINEERING

### CERTIFICATE OF COMPLETION

This is to certify that **S.SAKTHIVEL / MECH** has successfully completed "Two days Hands on workshop on Adobe Photoshop & Pagemaker" Conducted by Department of Computer Science and Engineering, E.G.S Pillay Engineering College, Nagapattinam from 06/09/2018 to 07/09/2018

  
**P. Anandraj**  
Coordinator

  
**J. Noorul Ameen**  
Coordinator

**ATTESTED**  
  
**Dr. S. RAMABALAN, M.E., Ph.D.,**  
PRINCIPAL

**Dr. M. Chinnababu**  
HOD

**ATTESTED**



**Dr. P.S. Ramabalan**  
PRINCIPAL  
E.G.S. Pillay Engineering College,  
Thethi, Nagore - 611 002,  
Nagapattinam (Dt) Tamil Nadu.

**E.G.S. Pillay Engineering College,**  
Thethi, Nagore - 611 002,  
Nagapattinam (Dt) Tamil Nadu.

18-19

**E.G.S PILAY ENGINEERING COLLEGE (AUTONOMOUS), NAGAPATTINAM**  
**Department of Information Technology**  
**ICT ACADEMY**

**REPORT ON FDP ON INTRODUCTION TO PYTHON  
PROGRAMMING**

(For IT, CSE, ECE, EEE & MCA)

Date: 12/11/2018 & 13/11/2018

Venue: CC3 Lab

| <b>S.NO</b> | <b>Content</b>          |
|-------------|-------------------------|
| 1.          | Permission letter       |
| 2.          | Brochure                |
| 3.          | Resource Person Profile |
| 4.          | Schedule                |
| 5.          | Attendance              |
| 6.          | Report                  |
| 7.          | Certificate             |
| 8.          | Feedback                |



**Coordinator**

**ATTESTED**



**Dr. S. RAMABALAN, M.E., Ph.D.,**  
**PRINCIPAL**

**E.G.S. Pillay Engineering College,**  
**Thethi, Nagore - 611 002.**  
**Nagapattinam (Dt) Tamil Nadu.**



BT-4



**E.G.S. PILLAY ENGINEERING COLLEGE**  
**DEPARTMENT OF INFORMATION TECHNOLOGY**

**In Association with**

**ICT ACADEMY**

**Innovate... Collaborate... Educate...**

**Organizes the Faculty Development Programme on**

**INTRODUCTION**  
**TO**  
**PYTHON PROGRAMMING**

**12/11/2018 & 13/11/2018**

**ATTESTED**

  
**Dr. S. RAMABALAN, M.E., Ph.D.,**  
**PRINCIPAL**  
**E.G.S. PILLAY ENGINEERING COLLEGE,**  
**NAGAPATTINAM - 611 002.**

**Coordinator**

**Mr.S.Manikandan**

**HOD/IT**

Dr. S. RAMABAI  
PRINCIPAL  
E.G.S. Pillay Engineering College  
Thethi, Nagore - 611 002  
Nagapattinam (Dt) Tamil Nadu

**ICT ACADEMY**  
Innovate... Collaborate... Educate...

A DECADE OF  
AUGMENTING  
NATION BUILDING

YEARS

Faculty Development Program on

 python™

PROGRAMMING



12& 13 Nov 2018 - EGS Pillay Engineering College (Autonomous), Nagapattinam

```
Returns a QuerySet of objects.  
"""  
set1 = self.filter(from_user=us1)  
set2 = self.filter(to_user=us2)  
return set1 | set2  
  
def are_connected(self, user1, user2):  
    if self.filter(from_user=user1, to_user=user2).exists():  
        return True  
    if self.filter(from_user=user2, to_user=user1).exists():  
        return True  
    return False  
  
def remove(self, user1, user2):  
    """  
    Deletes proper object from the database.  
    """  
    connection = self.filter(from_user=user1, to_user=user2).exists()  
    if not connection:  
        connection = self.filter(from_user=user2, to_user=user1).exists()
```

# E.G.S. PILLAY ENGINEERING COLLEGE (AUTONOMOUS)

Accredited by NBA (B.E. - CSE/EEE/MECH)

Affiliated to Anna University, Chennai | Approved by AICTE, New Delhi

[principal@egspec.org](mailto:principal@egspec.org) | [enquires@egspec.org](mailto:enquires@egspec.org)

Counselling Code : **3806**



Accredited by NAAC with Grade 'A'

An ISO 9001 : 2008 Certified Institution | Recognised by UGC 2(f) & 12(B)

+91-4365-251112 | +91-4365-251114

Old Nagore Road, Theithi, Nagapattinam - 611002, Tamil Nadu



ICT ACADEMY  
Innovate... Collaborate... Educate...

Faculty Development Program on

## Introduction to Python Programming

[12-November-2018 to 13- November-2018]

### Course Outline

- Module1: Introduction to Python
- Module2: Python Structured Data Types
- Module 3: Exceptions and Files
- Module 4: PyGame
- Module 5: Python GUI
- Module 6: Intro to Machine Learning & Regression

**ATTESTED:**

**Dr. S. RAMABALAN, M.E., Ph.D.,**  
**PRINCIPAL**

E.G.S. Pillay Engineering College,  
Theithi, Nagore - 611 002.  
Nagapattinam (Dt) Tamil Nadu.



**Registration**

From

S.Manikandan  
Head & Coordinator of ICTACT  
Department of Information Technology  
E.G.S.Pillay Engineering College  
Nagapattinam-611002

To

The principal  
E.G.S.Pillay Engineering College  
Nagapattinam-611002

Respected Sir,

Sub: Requesting to conduct two days faculty development programme -reg

We are happy to inform you that we plan to conduct a two days faculty development programme on Introduction to Python Programming from 12/11/2018 to 13/11/2018 in association with ICT Academy. This programme is useful for IT, CSE, ECE, EEE and MCA department faculty members,

Mr. Dinesh Kumar Gandhi Senior Technical trainer, Training & Research ICTACT is going to deliver the session for two days.

I want to use computer centre III for organizing this programme.

Thank You

Yours Truly,



(S.Manikandan)

**ATTESTED**  
  
**Dr. S. RAMABALAN, M.E., Ph.D.,**  
**PRINCIPAL**  
**E.G.S. Pillay Engineering College,**  
**Thethi, Nagore - 611 002.**  
**Nagapattinam (Dt) Tamil Nadu.**

E.G.S PILAY ENGINEERING COLLEGE (AUTONOMOUS), NAGAPATTINAM  
Department of Information Technology  
ICT ACADEMY

**REPORT ON FDP ON INTRODUCTION TO PYTHON  
PROGRAMMING**

(For IT, CSE, ECE, EEE & MCA)

Date: 12/11/2018 & 13/11/2018

Venue: CC3 Lab

**SCHEDULE**

| <b>Date</b> | <b>Session I<br/>(9.15 am to<br/>10.45 am)</b>  | <b>Session II<br/>(11.00am to<br/>12.30 pm)</b>                 | <b>Lunch<br/>Break</b> | <b>Session III<br/>(1.00pm to<br/>2.30 pm)</b> | <b>Session IV<br/>(3.00pm to<br/>4.30pm)</b> |
|-------------|---|---|------------------------|--|--|
| 12/11/2018  | Introduction to<br>Python<br>Programming        | Compare with<br>other<br>programming<br>languages, Data<br>sets |                        | Python Control<br>structures                   | Python Data<br>structure                     |
| 13/11/2018  | Modules &<br>packages,<br>Exception<br>handling | Numpy, Pandas   |                        | Solving challenging problems                   |  |



**Coordinator**

**(S.Manikandan)**

**ATTESTED**  
  
**Dr. S. RAMABALAN, M.E., Ph.D.,  
PRINCIPAL**  
E.G.S. Pillay Engineering College,  
Thethi, Nagore - 611 002.  
Nagapattinam (Dt) Tamil Nadu.



## **Dineshkumar Gandhi**

Have Completed Master of Science in Computer Science, Master of Philosophy in Computer Science from Bharathiar University & currently pursuing Doctorate at Bharathiar University with 6+ years of experience in IT Industry. Started career as Trainer in IBM CE, then worked with Innovative Dynamic Technologies.

Handling diversified technologies such as AWS, IBM Bluemix, Open Shift, Azure, Salesforce, Analyzing Data Using R, Cloud Infrastructure & Services, Data Science and Big Data Analytics, Mobile Application Development, Horton works HDP Developer, Cloudera, Hadoop Framework, SQL, NoSQL – Document Store, Graph based, Multimodel, Rapidminer, Tableau, Orange, Knime, SAS, Virtualization using vSphere 6.0, etc.

Interested in Cloud, Data Science and Neural Network

Currently Working in ICT Academy as Senior Technical Trainer, So far Trained 1000+ Faculties.

### **Certification:**

- AWS Certified Solutions Architect - Associate
- Certified Person from EMC2 Cloud Infrastructure and Services
- Certified Person from EMC2 Data Science and Big Data Analytics

**ATTESTED**  
  
**Dr. S. RAMABALAN, M.E., Ph.D.,**  
**PRINCIPAL**  
**E.G.S. Pillay Engineering College,**  
**Thethi, Nagore - 611 002.**  
**Nagapattinam (Dt) Tamil Nadu.**

## FDP Confirmation in EGS Pillay Engineering College (Autonomous) on 12th & 13th November 2018

Inbox

**Jairus**

Fri, Nov 9, 1:16 PM  
(19 hours ago)

Dear Sir / Madam,

Greetings from ICT Academy!

We are glad to inform you that Faculty Development Program (Introduction to Python Programming) in EGS Pillay Engineering College (Autonomous) on 12th & 13th November 2018 have been confirmed.

Total Faculty Registered: 31

Thank you

**Thanks & Regards,**  
J. Jairus,  
Relationship Manager,

**ICT Academy,**  
An Initiative of Government of India, State Govt. & Industry

BSNL Staff Quarters, Jaya Nagar, Reddiyarpalayam, Pondicherry- 10.  
Head Office: ELCOT Complex, Perungudi Industrial Estate, Chennai, TN 600 096, India.  
[jairus@ictacademy.in](mailto:jairus@ictacademy.in) / [www.ictacademy.in](http://www.ictacademy.in) / Mobile: 9500131019.

**ATTESTED**

  
**Dr. S. RAMABALAN, M.E., Ph.D.,**  
**PRINCIPAL**  
**E.G.S. Pillay Engineering College,**  
Thethi, Nagore - 615 007  
Nagapattinam (Dt)

**E.G.S PILLAY ENGINEERING COLLEGE (AUTONOMOUS), NAGAPATTINAM**  
 Department of Information Technology  
**ICT ACADEMY**

**FDP on Introduction to Python Programming**  
 (For IT, CSE, ECE, EEE & MCA)

Date: 12/11/2018 & 13/11/2018

Venue: CC3 Lab

Attendance Sheet - Internal

| S.No | Name of the Faculty     | Designation/Dept | Signature   |             |             |             |
|------|-------------------------|------------------|-------------|-------------|-------------|-------------|
|      |                         |                  | 12/11/2018  |             | 13/11/2018  |             |
|      |                         |                  | FN          | AN          | FN          | AN          |
| 1    | Arul Selvan G           | AP/CSE           | A           | A           | A           | A           |
| 2    | Arun Kumar P            | AP/IT            | A           | A           | A           | A           |
| 3    | C Mallika               | Asst. Prof / MCA | (Signature) | (Signature) | (Signature) | (Signature) |
| 4    | Hema A                  | AP/MCA           | (Signature) | (Signature) | (Signature) | (Signature) |
| 5    | Rakkiya                 | AP/MCA           | (Signature) | (Signature) | (Signature) | (Signature) |
| 6    | Mamikanandan S          | Prof / IT        | P           | P           | P           | P           |
| 7    | Praveenkumar            | AS/CSE           | P           | P           | P           | P           |
| 8    | R. G Gokila             | AP/IT            | (Signature) | (Signature) | (Signature) | (Signature) |
| 9    | Rajakumaran M           | AP/CSE           | R           | R           | R           | R           |
| 10   | Selvaganapathy          | AP/MCA           | S           | S           | S           | S           |
| 11   | Vanitha J               | Prof. / MCA      | (Signature) | (Signature) | (Signature) | (Signature) |
| 12   | Anandbabu R             | AP/IT            | R           | R           | R           | R           |
| 13   | Raju K                  | AP/IT            | R           | R           | R           | R           |
| 14   | Lavanya R               | AP/IT            | R           | R           | R           | R           |
| 15   | Nagalakshmi K           | AP/IT            | K           | K           | K           | K           |
| 16   | Govinda R G             | (Signature)      | (Signature) | (Signature) | (Signature) | (Signature) |
| 17   | Suresh V M              | AP/IT Suresh VM  | S           | S           | S           | S           |
| 18   | Ponnaravi P             | (Signature)      | (Signature) | (Signature) | (Signature) | (Signature) |
| 19   | Jim Hakinson            | AP/ECE           | J           | J           | J           | J           |
| 20   | Kateeshwari R S         | Asst. Prof / ECE | (Signature) | (Signature) | (Signature) | (Signature) |
| 21   | Aadhira S               | AP/ECE           | A           | A           | A           | A           |
| 22   | Baskar A                | AP/CSE           | B           | B           | B           | B           |
| 23   | Latha S                 | AP/ECE           | L           | L           | L           | L           |
| 24   | Amalore Naveen Antony B | AP/ECE           | (Signature) | (Signature) | (Signature) | (Signature) |
| 25   | Sivakumari S            | AP/EEE           | S           | S           | S           | S           |
| 26   | Chinnikandakumaran K    | AP/IT            | (Signature) | (Signature) | (Signature) | (Signature) |
| 27   | Naveen Anand            | AP/IT/CSE        | N           | N           | N           | N           |

**ATTESTED**  
  
**Dr. S. RAMABALAN, M.E., Ph.D.,**  
**PRINCIPAL**

**E.G.S. Pillay Engineering College,**  
 Thethi, Nagore - 611 002.  
 Nagapattinam (Dt) Tamil Nadu.

**E.G.S PILLAY ENGINEERING COLLEGE (AUTONOMOUS), NAGAPATTINAM**  
**Department of Information Technology**  
**ICT ACADEMY**

**FDP on Introduction to Python Programming**

(For IT, CSE, ECE, EEE & MCA)

Date: 12/11/2018 & 13/11/2018

Venue: CC3 Lab

Attendance Sheet - Internal

| S.No | Name of the Faculty | Designation/Dept | Signature  |    |            |    |
|------|---------------------|------------------|------------|----|------------|----|
|      |                     |                  | 12/11/2018 |    | 13/11/2018 |    |
|      |                     |                  | FN         | AN | FN         | AN |
| 28   | Anandraj P          | ASP/CSE          |            |    |            |    |
| 29   | Praveen Kumar S     | SP/CSE           |            |    |            |    |
| 30   | Vennila P           | AP/CSE           |            |    |            |    |
| 31   | Bala Subramanian K  | ASP/CSE          |            |    |            |    |

Course Coordinator

**Head of the Department**  
 Department of Information Technology  
 E.G.S. Pillay Engineering College  
 Nagapattinam - 611 002.

**ATTESTED**  
  
**Dr. S. RAMABALAN, M.E., Ph.D.,**  
**PRINCIPAL**  
 E.G.S. Pillay Engineering College,  
 Thethi, Nagore - 611 002.  
 Nagapattinam (Dt) Tamil Nadu.

**ICT ACADEMY**  
Innovate... Collaborate... Educate...

A DECADE OF  
AUGMENTING  
NATION BUILDING

**10**  
YEARS

## CERTIFICATE OF PARTICIPATION

CNo: F-41404

Date : 11-13-2018

### A HEMA

EGS PILLAY ENGINEERING COLLEGE(AUTONOMOUS), NAGAPATTINAM

has participated in 2 Day Faculty Development Program on

Introduction to Python Programming

**conducted by ICT Academy on 11-12-2018 to 11-13-2018 at**

EGS PILLAY ENGINEERING COLLEGE(AUTONOMOUS), NAGAPATTINAM



ATTESTED

*[Signature]*  
**Dr. S. RAMABALAN, M.E., Ph.D.,**  
PRINCIPAL

E.G.S. Pillay Engineering College,  
Thethi, Nagore - 611 002  
Nagapattinam (Dt) Tamil Nadu.

*[Signature]*  
B Anbuthambi  
Vice President, ICT Academy



## CERTIFICATE OF PARTICIPATION

CNo: F-41420  
Date : 11-13-2018

**R S KOTEESHWARI**

EGS PILLAY ENGINEERING COLLEGE(AUTONOMOUS), NAGAPATTINAM

has participated in 2 Day Faculty Development Program on  
Introduction to Python Programming

**conducted by ICT Academy on 11-12-2018 to 11-13-2018 at**

EGS PILLAY ENGINEERING COLLEGE(AUTONOMOUS), NAGAPATTINAM



**ATTESTED**

*[Signature]*  
**Dr. S. RAMABALAN, M.E., Ph.D.,**  
**PRINCIPAL**

**E.G.S. Pillay Engineering College,**  
Thethi, Nagore - 611 002,  
Nagapattinam (Dt) Tamil Nadu

*[Signature]*

B Anbuthambi  
Vice President, ICT Academy

## CERTIFICATE OF PARTICIPATION

CNo: F-41402

Date : 11-13-2018

**P ARUN KUMAR**

EGS PILLAY ENGINEERING COLLEGE(AUTONOMOUS), NAGAPATTINAM

has participated in 2 Day Faculty Development Program on

Introduction to Python Programming

**conducted by ICT Academy on 11-12-2018 to 11-13-2018 at**

EGS PILLAY ENGINEERING COLLEGE(AUTONOMOUS), NAGAPATTINAM



ATTESTED

*[Signature]*  
**Dr. S. RAMABALAN, M.E., Ph.D.,  
PRINCIPAL**

E.G.S. Pillay Engineering College,  
Thethi, Nagore - 611 002.  
Nagapattinam (Dt) Tamil Nadu.

*[Signature]*

B Anbuthambi  
Vice President, ICT Academy

## CERTIFICATE OF PARTICIPATION

CNo: F-41427

Date : 11-13-2018

**J NOORUL AMEEN**

EGS PILLAY ENGINEERING COLLEGE(AUTONOMOUS), NAGAPATTINAM

has participated in 2 Day Faculty Development Program on

Introduction to Python Programming

**conducted by ICT Academy on 11-12-2018 to 11-13-2018 at**

EGS PILLAY ENGINEERING COLLEGE(AUTONOMOUS), NAGAPATTINAM



**ATTESTED**

*[Signature]*  
**Dr. S. RAMABALAN, M.E., Ph.D.,**  
**PRINCIPAL**

**E.G.S. Pillay Engineering College,**  
Thethi, Nagore - 611 002  
Nagapattinam (Dt) Tamil Nadu

*[Signature]*  
B Anbuthambi  
Vice President, ICT Academy

## CERTIFICATE OF PARTICIPATION

CNo: F-41428

Date : 11-13-2018

**P ANANDRAJ**

EGS PILLAY ENGINEERING COLLEGE(AUTONOMOUS), NAGAPATTINAM

has participated in 2 Day Faculty Development Program on

Introduction to Python Programming

**conducted by ICT Academy on 11-12-2018 to 11-13-2018 at**

EGS PILLAY ENGINEERING COLLEGE(AUTONOMOUS), NAGAPATTINAM



**ATTESTED**

*[Signature]*  
**Dr. S. RAMABALAN, M.E., Ph.D.,  
PRINCIPAL**

**E.G.S. Pillay Engineering College,  
Thethi, Nagore - 611 002,  
Nagapattinam (Dt) Tamil Nadu.**

*[Signature]*  
**B Anbuthambi  
Vice President, ICT Academy**



Course Title: Introduction to Python Programming  
 Trainer Name: Mr. Dinesh Kumar godhi  
 Date: 12/11/2019 - 13/11/2019 Venue: CE 3 Lab

Please tick (✓) the appropriate score against each question.

| Questionnaire  | Below Average | Average | Fair | Good | Very Good |
|--|---------------|---------|------|------|-----------|
| The teaching structure of the module clear and consistent.   |               |         |      | ✓    |           |
| Completeness of the coverage of syllabus in accordance with learning objectives                            |               |         |      | ✓    |           |
| Balance between Theory, activities and discussions.  |               |         |      |      | ✓         |
| Length and Pace of the Program.  |               |         |      | ✓    |           |
| Quality & Coverage of the course materials provided.   |               |         | ✓    |      |           |
| Extent to which this course helped you in understanding the subject with respect to industry requirements. |               |         | ✓    |      |           |
| The trainer demonstrates skills with related examples and multiple evaluation methods.                     |               |         |      | ✓    |           |
| The trainer was able to make clear presentation and provide instructions.                                  |               |         |      | ✓    |           |
| Effectiveness of the practical activities.   |               |         |      | ✓    |           |
| Audio - Visual arrangements & Lab facilities   |               |         | ✓    |      |           |

Please give suggestions for the improvement of the course.

Need of more Practical Experiments  
Training

Your Contact details:

Name: S. Manikandan Designation: AP/IC  
 College /Company Name: EGSPEK  
 Email ID: manikandan@egspek.org Contact Number: 9042702685

**ATTESTED**  
  
**Dr. S. RAMABALAN, M.E., Ph.D.,**  
**PRINCIPAL**  
 E.G.S. Pillay Engineering College,  
 Thethi, Nagore - 611 002,  
 Nagapattinam (Dt) Tamil Nadu.



Course Title: Introduction Python Programming  
 Trainer Name: Mr. Dhinesh Kumar Gnanthi  
 Date: 12.11.2018 & 13.11.2018 Venue: CC3 Lab

Please tick (V) the appropriate score against each question.

| Questionnaire  | Below Average | Average | Fair | Good | Very Good |
|--|---------------|---------|------|------|-----------|
| The teaching structure of the module clear and consistent.   |               |         |      |      | ✓         |
| Completeness of the coverage of syllabus in accordance with learning objectives                            |               |         |      |      | ✓         |
| Balance between Theory, activities and discussions.  |               |         |      |      | ✓         |
| Length and Pace of the Program.  |               |         |      | ✓    |           |
| Quality & Coverage of the course materials provided.   |               |         |      | ✓    |           |
| Extent to which this course helped you in understanding the subject with respect to industry requirements. |               |         |      |      | ✓         |
| The trainer demonstrates skills with related examples and multiple evaluation methods.                     |               |         |      | ✓    |           |
| The trainer was able to make clear presentation and provide instructions.                                  |               |         |      |      | ✓         |
| Effectiveness of the practical activities.   |               |         |      | ✓    |           |
| Audio - Visual arrangements & Lab facilities   |               |         |      | ✓    |           |

Please give suggestions for the improvement of the course.

Please provide one week int program.

Your Contact details:

Name: R. Anand Babu Designation: AP  
 College /Company Name: E. G. S. Pillay Engineering College  
 Email ID: anandbabu@egssec.org Contact Number: 9600768107

ATTESTED

  
 Dr. S. RAMABALAN, M.E., Ph.D.,  
 PRINCIPAL  
 E.G.S. Pillay Engineering College,  
 Thethi, Nagore - 611 002  
 Nagapattinam (Dt) Tamil Nadu.

Course Title: Introduction of python programming  
 Trainer Name: Mri Srinesh kumar canthi  
 Date: 12/11/2018 to 13/11/2018 Venue: CC3 - Lab.

Please tick (V) the appropriate score against each question.

| Questionnaire  | Below Average | Average | Fair | Good | Very Good |
|--|---------------|---------|------|------|-----------|
| The teaching structure of the module clear and consistent.   |               |         |      | X    |           |
| Completeness of the coverage of syllabus in accordance with learning objectives                            |               |         |      | X    |           |
| Balance between Theory, activities and discussions.  |               |         |      |      | X         |
| Length and Pace of the Program.  |               |         |      |      | X         |
| Quality & Coverage of the course materials provided.   |               |         |      | X    |           |
| Extent to which this course helped you in understanding the subject with respect to industry requirements. |               |         |      | X    |           |
| The trainer demonstrates skills with related examples and multiple evaluation methods.                     |               |         | X    |      |           |
| The trainer was able to make clear presentation and provide instructions.                                  |               |         |      | X    | X         |
| Effectiveness of the practical activities.   |               |         |      |      | X         |
| Audio - Visual arrangements & Lab facilities   |               |         |      | X    |           |

Please give suggestions for the improvement of the course.

It was very useful programme

Your Contact details:

Name: R. G. Lakshmi Designation: AP / IT  
 College / Company Name: E.G.S. Pillay Eng College  
 Email ID: l.lakshmi@egscollege.com Contact Number: 9984946296

**Dr. S. RAMABALAN, M.E., Ph.D.,**  
**PRINCIPAL**  
 E.G.S. Pillay Engineering College,  
 Thethi, Nagore - 611 002.  
 Nagapattinam (Dt) Tamil Nadu.



Course Title: Introduction of Python Programming  
 Trainer Name: Mrs. Shreshth Kurum Gandhi  
 Date: 12-11-18 to 13-11-2018 Venue: CC 2 - Lab

Please tick (✓) the appropriate score against each question.

| Questionnaire  | Below Average | Average | Fair | Good | Very Good |
|--|---------------|---------|------|------|-----------|
| The teaching structure of the module clear and consistent.   |               |         |      |      | ✓         |
| Completeness of the coverage of syllabus in accordance with learning objectives                            |               |         |      |      | ✓         |
| Balance between Theory, activities and discussions.  |               |         |      | ✓    |           |
| Length and Pace of the Program.  |               |         |      |      | ✓         |
| Quality & Coverage of the course materials provided.   |               |         |      |      | ✓         |
| Extent to which this course helped you in understanding the subject with respect to industry requirements. |               |         |      |      | ✓         |
| The trainer demonstrates skills with related examples and multiple evaluation methods.                     |               |         |      | ✓    |           |
| The trainer was able to make clear presentation and provide instructions.                                  |               |         |      |      | ✓         |
| Effectiveness of the practical activities.   |               |         |      |      | ✓         |
| Audio - Visual arrangements & Lab facilities   |               |         |      |      | ✓         |

Please give suggestions for the improvement of the course.

useful program for course development  
and syllabus. project based development  
python program needed.

Your Contact details:

Name: V.M. GURURAJA Designation: AP/PT  
 College / Company Name: PACPE - Nagai  
 Email ID: vmauraj@pacpe.org Contact Number: 97 50 50 24 34

ATTESTED

**Dr. S. RAMABALAN, M.E., Ph.D.,**  
**PRINCIPAL**

**E.G.S. Pillay Engineering College,**  
**Nagapattinam (Dt) Tamil Nadu.**

Course Title: Introduction of Python Programming  
 Trainer Name: Mr. Praveen Kumar S  
 Date: 12/11/2018 to 13/11/2018 Venue: C12-100

Please tick (V) the appropriate score against each question.

| Questionnaire  | Below Average | Average | Fair | Good | Very Good |
|--|---------------|---------|------|------|-----------|
| The teaching structure of the module clear and consistent  |               |         |      |      | ✓         |
| Completeness of the coverage of syllabus in accordance with learning objectives                            |               |         |      | ✓    |           |
| Balance between Theory, activities and discussions.  |               |         |      |      | ✓         |
| Length and Pace of the Program.  |               |         |      |      | ✓         |
| Quality & Coverage of the course materials provided.   |               |         |      | ✓    |           |
| Extent to which this course helped you in understanding the subject with respect to industry requirements. |               |         |      |      | ✓         |
| The trainer demonstrates skills with related examples and multiple evaluation methods.                     |               |         |      | ✓    |           |
| The trainer was able to make clear presentation and provide instructions.                                  |               |         |      | ✓    |           |
| Effectiveness of the practical activities.   |               |         |      |      | ✓         |
| Audio - Visual arrangements & Lab facilities   |               |         |      |      | ✓         |

Please give suggestions for the improvement of the course.

This program was very help full to gain a  
Programming knowledge we need such a programming  
Activities

Your Contact details:

Name: Praveen Kumar S Designation: AD  
 College /Company Name: E.G.S PILLAY ENGINEERING COLLEGE NAGAPATTINAM  
 Email ID: praveen.kumar@egspec.org Contact Number: 9786465881

**ATTESTED**  
  
**Dr. S. RAMABALAN, M.E., Ph.D.,**  
**PRINCIPAL**  
 E.G.S. Pillay Engineering College,  
 Thethi Nagora - 611 002.  
 Nagapattinam (Dt) Tamil Nadu.

**E.G.S PILAY ENGINEERING COLLEGE (AUTONOMOUS),  
NAGAPATTINAM**

**Department of Information Technology**

**ICT ACADEMY**

**FDP ON INTRODUCTION TO PYTHON PROGRAMMING**

**(For IT, CSE, ECE, EEE & MCA)**

Date: 12/11/2018 & 13/11/2018

Venue: CC3 Lab

**REPORT**

Department of Information Technology, E.G.S. Pillay Engineering college organized a Faculty Development Program on *Introduction to Python Programming* from 12<sup>th</sup> – 13<sup>th</sup> Nov, 2018 for IT, CSE, ECE, EEE & MCA department faculties.

The FDP aimed to acquaint the participants with Python language and make them comfortable with the new curriculum.

Trainers for the FDP were Mr. Dinesh Kumar Gandhi Senior technical trainer, ICTACT. The FDP was coordinated by Prof S Manikandan Head of the department, Information Technology.

FDP started with a ice-breaking session of introduction of trainers and participants. Participants were apprised about the capabilities and applications of Python.

The FDP covered the basics of Python programming, Control Structures, Data Structures, Functions, Modules, Packages and Exception Handling.

The two days sessions were very interactive and loaded with hands-on, quizzes and assignments to get the complete understanding of the topics delivered. There were certain energizing activities conducted in-between the sessions to create an amiable environment for the learners. FDP was a great success and all are participated with full enthusiasm.

Feedback collected from all the participants all are written like it was very useful also they need 5 days FDP on Python programming.

The participants were felicitated with participation certificate.

**ATTESTED**

**Dr. S. RAMABALAN, M.E., Ph.D.,  
PRINCIPAL**

**E.G.S. Pillay Engineering College,  
Thethi, Nagore - 611 002,  
Nagapattinam (Dt) Tamil Nadu.**



**Co Ordinator**

**(S.Manikandan)**



# E.G.S. PILLAY ENGINEERING COLLEGE (AUTONOMOUS)

Accredited by NBA (B.E. - CSE/EEE/MECH)

Affiliated to Anna University, Chennai | Approved by AICTE, New Delhi



Accredited by NAAC with Grade 'A'

An ISO 9001:2015 Certified Institution | Recognised by UGC 2(f) & 12(B)

principal@egspec.org | enquires@egspec.org

+91-4365-251112 | +91-4365-251114

Counseling Code: **3806**

Old Nagore Road, Thethi, Nagapattinam - 611002, Tamil Nadu NIKF Engineering Parking top **200** in India

## PROCEEDINGS OF THE INTERNATIONAL CONFERENCE ON RESEARCH AND DEVELOPMENT IN ENGINEERING, TECHNOLOGY, MANAGEMENT, SCIENCE AND ITS APPLICATIONS - 2019 (ICRDETMSA – 2019)

IN ASSOCIATION WITH,  
ASSOCIATION OF SCIENTISTS, DEVELOPERS AND FACULTIES  
(ASDF)

29 & 30 MARCH 2019

VOLUME 1

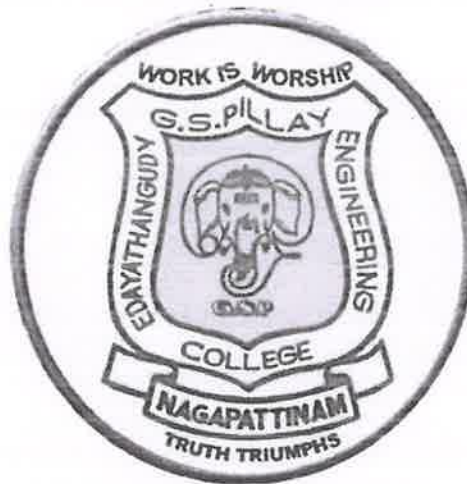

ORGANIZED BY

DEPARTMENT OF MANAGEMENT STUDIES  
E.G.S. PILLAY ENGINEERING COLLEGE (AUTONOMOUS)  
NAGAPATTINAM, INDIA – 611002

College Website: [www.egspec.org](http://www.egspec.org)

Conference Website: <https://confintl.org/icrdetmsa/>

Phone: 04365251112

ATTESTED  
Fax: 04365251114  
  
Dr. S. RAMABALAN, M.E., Ph.D.,  
PRINCIPAL  
E.G.S. Pillay Engineering College,  
Thethi, Nagore - 611 002,  
Nagapattinam (Dt) Tamil Nadu.

# E.G.S. PILLAY ENGINEERING COLLEGE (AUTONOMOUS)

Approved by NBA (B.E. - CSE/EEE/MECH)

to Anna University, Chennai | Approved by AICTE, New Delhi

egspec.org | enquires@egspec.org

Eng Code: 3806



Accredited by NAAC with Grade 'A'

An ISO 9001:2015 Certified Institution | Recognised by UGC 2(F) & 12(B)

+91-4365-251112 | +91-4365-251114

Old Nagore Road, Thethi, Nagapattinam - 611002, Tamil Nadu NRI Engineering Ranking Top 200 in India

## PROCEEDINGS OF THE INTERNATIONAL CONFERENCE ON RESEARCH AND DEVELOPMENT IN ENGINEERING, TECHNOLOGY, MANAGEMENT, SCIENCE AND ITS APPLICATIONS - 2019 (ICRDETMSA - 2019)

IN ASSOCIATION WITH,  
ASSOCIATION OF SCIENTISTS, DEVELOPERS AND FACULTIES  
(ASDF)

& 30 MARCH 2019

VOLUME 1



ORGANIZED BY

DEPARTMENT OF MANAGEMENT STUDIES  
E.G.S. PILLAY ENGINEERING COLLEGE (AUTONOMOUS)  
NAGAPATTINAM, INDIA - 611002

College Website: [www.egspec.org](http://www.egspec.org)

Conference Website: <https://confintl.org/icrdetmsa/>

Phone: 04365251112

Fax: 04365251114

ATTESTED  
  
Dr. S. RAMABALAN, M.E., Ph.D.,  
PRINCIPAL  
E.G.S. Pillay Engineering College,  
Thethi, Nagore - 611 002,  
Nagapattinam (Dt) Tamil Nadu.

**E.G.S. PILLAY ENGINEERING COLLEGE (AUTONOMOUS)  
NAGAPATTINAM 611002**

(An ISO 9001:2015 certified institution)

(Approved by AICTE ,New Delhi & Affiliated to Anna University,Chennai )

International Conference On Research And Development in Engineering, Technology, Management,  
Science And its Applications (ICRDETMSA- 2019)



**MESSAGE**



I am delighted that the International Conference On Research And Development In Engineering, Technology, Management, Science And Its Applications(ICRDETMSA- 2019) is taking place on 29<sup>th</sup> and 30<sup>th</sup> march 2019 in EGS PILLAY ENGINEERING COLLEGE (AUTONOMOUS) NAGAPATTINAM.I heartily wish the organizers to taste the success in their endeavours now and forever. The success should stir their attempts to be varied and innovative and wish them God speed, so that all the delegates, scholars and participants may look forward to conduct of similar conference. It is said "Men are rich only as they give. He who gives service gets great rewards". I have great pleasure in welcoming all the participants.

Let the college benefits, society reap the explosion of technical knowledge, development and growth and move towards the prosperity of the Nation at large .

May God shower his blessing on all who make an attempt towards a "fabulous future".

*S. Paramesvaran*

**Dr.Chev.S.Paramesvaran ,  
Secretary,  
E.G.S Pillay Group Of Institutions,  
Nagapattinam**

**ATTESTED**

**Dr. S. RAMABALAN, M.E., Ph.D.,  
PRINCIPAL  
E.G.S. Pillay Engineering College,  
Thethi, Nagore - 611 002.  
Nagapattinam (Dt) Tamil Nadu.**



**E.G.S. PILLAY ENGINEERING COLLEGE (AUTONOMOUS)  
NAGAPATTINAM 611002**

(An ISO 9001:2015 certified institution)

(Approved by AICTE, New Delhi & Affiliated to Anna University, Chennai)

International Conference On Research And Development in Engineering, Technology, Management,  
Science And its Applications (ICRDETMISA- 2019)



**MESSAGE**



Welcome to the International Conference On Research And Development In Engineering, Technology, Management, Science And Its Applications (ICRDETMISA- 2019) during 29-30, March 2019. The ICRDETMISA- 2019 provides a perfect forum for engineering professionals and academic researchers to exchange update knowledge, experience and views on key areas of engineering and technology.

The conference has the focus on the frontiers topics in the Computer Science, Civil, Mechanical, Electrical and Electronics Engineering, information technology, Computer Applications, Business Administration and other pioneering fields in Engineering, technology and Science. The conference will be held every year to make it an ideal platform for people to share views and experience in engineering and technology and related areas.

I am sure that the conference will create an awareness among the industry personnel and academic researchers.

On behalf of the organizing committee of ICRDETMISA- 2019, we express our heartfelt thanks to our management, especially to our honourable secretary Dr. Chev. S. Parmesvaran for his endless support for conducting this conference in a grand successful manner. We thank the voluntary effort of all the faculty member of all departments and the respectable reviewers. We extend our thanks to advisory board members for their creative effort and co-operative support.

**Dr. S. Ramabalan, ME, Ph.D**  
Principal,  
E.G.S. Pillay Engineering College  
Nagapattinam

ATTESTED

**Dr. S. RAMABALAN, M.E., Ph.D.,**  
PRINCIPAL  
E.G.S. Pillay Engineering College,  
Thethi, Nagore - 611 002.  
Nagapattinam (Dt) Tamil Nadu.



**E.G.S. PILLAY ENGINEERING COLLEGE (AUTONOMOUS)  
NAGAPATTINAM 611002**

(An ISO 9001:2015 certified institution)

(Approved by AICTE, New Delhi & Affiliated to Anna University, Chennai)

International Conference On Research And Development in Engineering, Technology, Management,  
Science And its Applications (ICRDETMSA- 2019)



**MESSAGE**



It is heartening to note that our college is organizing a two day International Conference On Research And Development In Engineering, Technology, Management, Science And Its Applications(ICRDETMSA- 2019). Organizing international conference will definitely provide a platform for the researchers, scientists, teachers and students to come together to share their knowledge and interest on current topics.

I wish the international conference a grand success.

**Dr.R.Karthi  
Director/MBA  
E.G.S.Pillay Engineering College  
Nagapattinam**

**ATTESTED**

**Dr. S. RAMABALAN, M.E., Ph.D.,  
PRINCIPAL  
E.G.S. Pillay Engineering College,  
Thethi, Nagore - 611 002.  
Nagapattinam (Dt) Tamil Nadu.**

## KEYNOTE SPEAKERS



**DONG HWA KIM**

**Prof. Dr. Dong Hwa Kim**, Chargé d' affaires of Higher Education in South Korea is Honourable Emeritus Professor of Hanbat National University, South Korea. He has been additionally responsible for HuCARE Research Center based out of Daejeon, South Korea. He has acquired double doctorate from Ajou University Korea and TIT (Tokyo Institute of Technology, Japan) on Multivariable Turbo Generating system by State feedback and Genetic Algorithm Combined with Particle Swarm Optimization Bacterial Foraging and Its Application to PID Controller Tuning respectively.



**PROF. M.M.M. NAJIM**

**PROF. M.M.M. NAJIM** VICE-CHANCELLOR SOUTH EASTERN UNIVERSITY OF SRI LANKA, OLUVIL, SRI LANKA Professor M.M.M. Najim was born on 06th March 1968 in Navinna, Galle and obtained his primary education from Vidyaloka Maha Vidyalaya, Galle and his secondary education from Richmond College, Galle. He then entered to the Faculty of Agriculture, University of Peradeniya and earned a first class honours B.Sc. degree specialized in Agricultural Engineering in 1994. Since the date of completion of his basic degree, he has served as an academic. He has served in three Universities before appointed as the Vice Chancellor of the South Eastern University of Sri Lanka. Professor Najim has been ranked as one of the most outstanding Sri Lankan Scientists. He has produced three Ph.D. holders, 1 M.Phil. holder and 3 Masters degree holders. At present he is supervising three Ph.D. students.



**KOKULA KRISHNA HARI K**

**Kokula Krishna Hari K** an Indian born in Pondicherry, South India in 1980's is a pure veteran with acquired knowledge in Business Administration, Computer Research and Entrepreneurship. Has a wide range of contacts through various pipelines and channels across the globe either in Academic Network or Industrial Network or Research Network. Carried away with a greater commitment to the consold projects, he has helped many people to achieve greater laurels. With the loads of experience with major IT firms, he has been acquainted with the work culture and implemented the absolute opposite factor into them. He is one of the youngest international conference organizers in the current scientific world who has received the Australian Youngest Entrepreneur Award. He is serving as Visiting Faculty in many Universities across the world and educates. He is a constant researcher in the field of Computer Network Security.

ATTESTED

A handwritten signature in blue ink, appearing to read 'Dr. S. Ramabalan'.

**Dr. S. RAMABALAN, M.E., Ph.D.,**  
**PRINCIPAL**

E.G.S. Pillay Engineering College,  
Thethi, Nagore - 611 002.  
Nagapattinam (Dt) Tamil Nadu.

## **PREFACE**

We feel a great sense of pride and pleasure in bringing out the proceeding of the International conference on Research and Development in Engineering, Technology, Management, Science and its Applications (ICRDETMSA-2019). This will be of immense help to the authors and remain a permanent asset to their academic calibre. As an added advantage proceedings are issued. It is certainly a laudable attempt of the organizer of the conference. Suggestion for the better presentations and critical remarks for avoidance is welcomed.

**Editorial Committee**

**ATTESTED**



**Dr. S. RAMABALAN, M.E., Ph.D.,**  
**PRINCIPAL**  
E.G.S. Pillay Engineering College,  
Thethi, Nagore - 611 002,  
Nagapattinam (Dt) Tamil Nadu.

## CONTENTS

| LN.No. | Paper ID | Title of the Papers & Authors  | Page No. |
|--------|----------|--|----------|
| 1.     | MBA 01   | MASTER OF BUSINESS ADMINISTRATION<br>CHALLENGES FACED BY THE STUDENTS WHILE APPEARING<br>COMPETITIVE EXAMINATIONS  | 01       |
| 2.     | MBA 02   | A STUDY ON CAPITAL BUDGETING IN AAVIN DISTRICT<br>COOPERATIVE MILK PRODUCER UNION LIMITED AT TRICHY<br>R.Kaviya, MBA   | 01       |
| 3.     | MBA 03   | A STUDY ON EMPLOYEE RETENTION IN PURE TECH INDIA<br>PRIVATE LIMITED AT TRICHY<br>S.Ezhilarasi, MBA   | 02       |
| 4.     | MBA 04   | A STUDY ON CAPITAL STRUCTURE AT SRI LAKSMI NARAYANA<br>CO-OPERATIVE URBAN BANK LTD, TIRUVARUR<br>B.Abila, MBA  | 02       |
| 5.     | MBA 05   | HEALTH RELATED ISSUES AND THE EFFECTIVENESS OF<br>GOVERNMENT INSURANCE SCHEME AMONG ECONOMICALLY<br>BACKWARD WOMEN IN NAGAPATTINAM DISTRICT<br>K.Mageshwari, MBA   | 03       |
| 6.     | MBA 06   | A STUDY ON THE WELFARE SCHEMES OF GOVERNMENT<br>REACHED THE RURAL PEOPLE IN SOME AREAS OF THIRUVARUR<br>Dr. R.Karthi, Professor  | 04       |
| 7.     | MBA 07   | FINANCIAL PERFORMANCE IN NEOMAX PROMOTERS LIMITED IN<br>CHIDHABARAM<br>K.R. Poonguzhali, MBA   | 04       |
| 8.     | MBA 08   | A STUDY ON ORGANIZATIONAL EFFECTIVENESS OF ANCILLARY<br>INDUSTRIES IN BHEL AT TRICHY<br>R. Kayalvizhi, MBA & <sup>2</sup> B.AshaDaisy Assistant<br>Professor   | 05       |
| 9.     | MBA 09   | A STUDY ON EMPLOYEE WELFARE MEASURES IN TRICHY AGRO<br>INDUSTRY AT TRICHY<br>Mrs.B.Asha Daisy, Assistant Professor   | 05       |
| 10.    | MBA 10   | A STUDY AND EVALUATION OF SAFETY AND WELFARE<br>MEASURES PROVIDED IN AMMAIYAR MILK DAIRY AT<br>KARATAKAL<br>P.Pavithra, MBA  | 06       |
| 11.    | MBA 11   | A STUDY ON EMPLOYEE GRIEVANCES MANAGEMENT SYSTEM<br>IN AKR INDUSTRY AT TRICHY<br>R.Prashanthi, MBA   | 06       |
| 12.    | MBA 12   | A STUDY ON FINANCIAL PERFORMANCE ANALYSIS IN CANARA<br>BANK AT NAGAPATTINAM<br>D.Sabiya, MBA   | 07       |
| 13.    | MBA 13   | A STUDY OF INVENTORY MANAGEMENT IN ELITE<br>CONSTRUCTOR Pvt Ltd, AT CHENNAI<br>M.Pavithra MBA  | 07       |
| 14.    | MBA 14   | A STUDY ON EMPLOYEE PERCEPTION ABOUT ORGANIZATION<br>CLIMATE AND CULTURE IN ADDISON & CO LIMITED AT<br>IRUNGATUKOTAI, CHENNAI<br><sup>1</sup> K. Azharudeen, MBA & <sup>2</sup> Ms. P.Vinotha, Assistant Professor | 08       |
| 15.    | MBA 15   | A STUDY ON WORKING CAPITAL MANAGEMENT IN SRI<br>KAMALAMBIKA CO OPERATIVE URBAN BANK LTD AT<br>THIRUVARUR<br>T. Vijayalakshmi, MBA  | 08       |
|        |          | S. Sathishkumar, MBA   |          |

**ATTESTED**

  
Dr. S. RAMABALAN, M.E., Ph.D.,  
PRINCIPAL

E.G.S. Pillay Engineering College,  
Thethi, Nagore - 611 002.  
Nagapattinam (Dt) Tamil Nadu.



|     |        |  |    |
|-----|--------|--|----|
| 16. | MBA 16 | A STUDY ON WORK LIFE BALANCE OF EMPLOYEES IN HIDE SIGN INDIA PRIVATE LIMITED AT PUDUCHERY                            | 09 |
|     |        | P.G.Saravanan, MBA   |    |
| 17. | MBA 17 | A STUDY ON EMPLOYEE WELFARE IN SUN INDUSTRY, AT TRICHY   | 10 |
|     |        | <sup>1</sup> R.Navajayavignesh, MBA & <sup>2</sup> L.Aarthi, Assistant Professor                                     |    |
| 18. | MBA 18 | A STUDY ON EMPLOYEE RETENTION IN MAULIK LEATHER CRAFTS PRIVATE LIMITED. AT METTUPALAYAM, PUDUCHERY                   | 10 |
|     |        | G.Sarumathy, MBA   |    |
| 19. | MBA 19 | A STUDY ON PERFORMANCE APPRAISAL IN VARIFAB ENGINEERING PRIVATE LIMITED AT CHENNAI                                   | 11 |
| 20. | MBA 20 | MATHEMATICAL MODELLING ON HEALTH DISORDERS AMONG WOMEN   | 11 |
|     |        | M.Roobhiya, MBA  |    |
|     |        | Dr.P.Jamuna Devi, 2 Dr.R.SophiaPorchelvi 3 Dr.G.Sudha,   |    |
| 21. | MBA 21 | A STUDY ON INDUSTRIAL RELATION IN PRISM JOHNSON INDUSTRIES PVT LID., KARAİKAL  | 12 |
|     |        | J.Pramila, MBA   |    |
| 22. | MBA 22 | A STUDY ON EMPLOYEE PERCEPTION TOWARDS ORGANIZATIONAL CLIMATE IN OIL AND NATURAL GAS CORPORATION LIMITED AT KARAİKAL | 12 |
|     |        | <sup>1</sup> V.Sudhanthiradevi, MBA & <sup>2</sup> P.Balaishwarya, Assistant professor                               |    |
| 23. | MBA 23 | A STUDY ON WELFARE MEASURES OF WOMEN EMPLOYEES IN INASHOK LEYLAND AT CHENNAI   | 13 |
|     |        | S.Rajalakshmi, MBA   |    |
| 24. | MBA 24 | A STUDY ON RELATIONSHIP BETWEEN EMPLOYER AND EMPLOYEE IN OIL AND NATURAL GAS CORPORATION LIMITED AT KARAİKAL         | 14 |
|     |        | S. Saranya, MBA  |    |
| 25. | MBA 25 | A STUDY ON QUALITY OF WORLIFE IN RADHA METAL INDUSTRY AT TRICHY  | 14 |
|     |        | P.Santhiya, MBA  |    |
| 26. | MBA 26 | FINANCIAL PERFORMANCE ANALYSIS OF HDB FINANCIAL SERVICE AT TRICHY  | 15 |
|     |        | R.Sivakumar, MBA   |    |
| 27. | MBA 27 | A STUDY ON INFLUENCE OF RECRUITMENT AND SELECTION PROCESS ON ORGANIZATIONAL GROWTH IN PRABHA ENGINEERS AT CHENNAI    | 15 |
|     |        | <sup>1</sup> J.Prceethi, MBA & <sup>2</sup> Mr.S.Sushil Allam, Assistant Professor                                   |    |
| 28. | MBA 28 | A STUDY ON EMPLOYEE STRESS MANAGEMENT IN LIVIA POLYMER BOTTLES PRIVATE LIMITED AT TRICHY                             | 16 |
|     |        | G. Praveen, MBA  |    |
| 29. | MBA 29 | A STUDY ON STRESS MANAGEMENT IN PERAGATHI HITECH SYSTEM AT CHENNAI   | 16 |
|     |        | G. Suganya, MBA  |    |
| 30. | MBA 30 | A SURVEY ON DIGITALIZATION SYSTEMS OF EDUCATION IN GOVERNMENT SCHOOL AT NAGAPATTINAM REGION                          | 17 |
|     |        | A. Buchiya, MBA  |    |

ATTESTED



Dr. S. RAMABALAN, M.E., Ph.D.,  
PRINCIPAL

E.G.S. Pillay Engineering College,  
Trichy, Nagore - 611 002.  
Nagapattinam (Dt) Tamil Nadu.

|     |        |  |    |
|-----|--------|--|----|
| 31. | MBA 31 | A STUDY ON EMPLOYEE LABOUR WELFARE IN ASIAN STEEL PVT LTD AT TRICHY  | 17 |
|     |        | B.Praveen Kumar, MBA   |    |
| 32. | MBA 32 | A STUDY ON EMPLOYEE MOTIVATION IN GODREJ CONSUMER PRODUCTS LIMITED   | 18 |
|     |        | B.Manimozhi, MBA   |    |
| 33. | MBA 33 | A STUDY ON NON PERFORMING ASSETS IN SRI LAKSHMINARAYANA CO-OPERATIVE URBAN BANK LIMITED AT THIRUVARUR        | 18 |
|     |        | R. Kasthuri, MBA   |    |
| 34. | MBA 34 | A STUDY ON EMPLOYEE RETENTION IN LIVIER BOBBLE PVT LTD AT TRICHY   | 19 |
|     |        | S.Ponnarasu, MBA   |    |
| 35. | MBA 35 | A STUDY ON TIME MANAGEMENT IN SISCO SOLAR PRIVATE LIMITED AT TRICHY  | 19 |
|     |        | J. Nivetha, MBA  |    |
| 36. | MBA 36 | A STUDY ON TIME MANAGEMENT HDB FINANCE SERVICE AT TRICHY   | 20 |
|     |        | V.Gunabalan, MBA   |    |
| 37. | MBA 37 | A STUDY ON EMPLOYEE WELFARE AND SAFETY MEASURES, HELD IN ASHOK LEYLAND AT CHENNAI                            | 21 |
|     |        | A.Sowamalakshmi, MBA   |    |
| 38. | MBA 38 | A STUDY ON GRIEVANCES HANDLING MECHANISM IN HIDE SIGN INDIA PRIVATE LTD AT PONDICHERRY                       | 21 |
|     |        | S.Priyanka, MBA  |    |
| 39. | MBA 39 | A STUDY ON EMPLOYEE ENGAGEMENT STRATEGIES IN PARPANCH PET PRIVATE LTD AT TRICHY                              | 22 |
|     |        | N.Manivannan, MBA  |    |
| 40. | MBA 40 | A STUDY ON EMPLOYEE WELFARE MEASURES WITH SPECIAL REFERENCE TO AUTOKSHI ENGINEERS AT CHENNAI                 | 22 |
|     |        | K.Kokila, MBA  |    |
| 41. | MBA 41 | A STUDY ON EMPLOYEE SATISFACTION IN SHRI AMMAN STEEL AND ALLIED INDUSTRIES (P) LTD AT TRICHY                 | 23 |
|     |        | S.Saranya, MBA   |    |
| 42. | MBA 42 | A STUDY ON EMPLOYEE ENGAGEMENT MANAGEMENT SYSTEM IN SPECIAL REFERENCES TO HASHANA PACKS AND PRINTERS, TRICHY | 23 |
|     |        | M.Rajasri, MBA   |    |
| 43. | MBA 42 | A STUDY ON PERFORMANCE APPRAISAL IN SPANSYS TECHNOLOGY SOLUTION AT KUMBAKONAM                                | 24 |
|     |        | R.Praveenkumar, MBA  |    |
| 44. | MBA 44 | A STUDY ON GRIEVANCE HANDLING SYSTEM IN ADDISON & CO LTD AT CHENNAI  | 24 |
|     |        | S.Sarulatha, MBA   |    |
| 45. | MBA 45 | A STUDY ON EMPLOYEE RETENTION IN SPECIAL REFERENCE OF SUN INDUSTRY, AT TRICHY                                | 25 |
|     |        | R.Kannayiramoorthy, MBA  |    |
| 46. | MBA 46 | A STUDY ON QUALITY MANAGEMENT SYSTEM OF SUJA SHOEI AT VILLIYANALLUR  | 26 |
|     |        | A Keerthana, MBA   |    |

ATTESTED

  
Dr. S. RAMABALAN, M.E., Ph.D.,  
PRINCIPAL  
E.G.S. Pillay Engineering College,  
Thattai, Nagore - 611 002.  
Nagapattinam (Dt) Tamil Nadu.

|    |        |  |    |
|----|--------|--|----|
| 47 | MBA 47 | A STUDY ON EMPLOYEES JOB SATISFACTION TOWARDS THEIR<br>WORK ON OIL & NATURAL GAS CORPORATION AT KARAIKAL<br>M.Reetha, MBA    | 26 |
| 48 | MBA 48 | A STUDY AND PERFORMANCE OF MUTUAL FUNDS WITH<br>SPECIAL FOCUS ON COIMBATORE CAPITAL LIMITED AT<br>KARAIKAL<br>K.Nirmala, MBA | 27 |
| 49 | MBA 49 | A STUDY ON QUALITY OF WORLIFE IN RK METAL ROOFINGS (P)<br>LTD AT TRICHY<br>P.Subashrce, MBA                                  | 27 |
| 50 | MBA 50 | A STUDY ON EMPLOYEE RETENTION IN R.K METAL ROOFINGS<br>(P) LTD AT TRICHY<br>R.Anupriya, MBA                                  | 28 |
| 51 | MBA 51 | A STUDY ON QUALITY OF WORK LIFE IN MOXSHWA SOFT<br>DRINKS AT COIMBATORE<br>G.Mathibalan, MBA                                 | 29 |
| 52 | MBA 52 | A STUDY ON EMPLOYEE RELATIONSHIP WITH<br>SPECIAL REFERENCE TO PRAPANCHA PET AT TRICHY<br>M.Mohamed Naseem, MBA               | 29 |
| 53 | MBA 53 | IMPLEMENTING HUMAN RESOURCE MANAGEMENT PRACTICES -<br>IN AGRICULTURE<br>Mr.S.Sakthi Kamal Nathan, Assistant Professor        | 30 |

ATTESTED

  
Dr. S. RAMABALAN, M.E., Ph.D.,  
PRINCIPAL  
E.G.S. Pillay Engineering College,  
Thethi, Nagore - 611 002.  
Nagapattinam (Dt) Tamil Nadu.

## HEALTH RELATED ISSUES AND THE EFFECTIVENESS OF GOVERNMENT INSURANCE SCHEME AMONG ECONOMICALLY BACKWARD WOMEN IN NAGAPATTINAM DISTRICT

Dr. R.Karthi, Professor  
Department of Management Studies  
E.G.S.Pillay Engineering College, Nagapattinam-611002, Tamilnadu

*Abstract:* Health insurance is a method of protecting the health of the people by getting an insurance policy from the general insurance players. Policyholders are paying a fee called premium for the continuation of services from the insurance providers. The research shows that the health related issues faced by the women and the initiative taken by the government to provide health insurance for protecting economically backward women. Health indicators of a country is analyzed through the various criteria such as mortality rate, morbidity rates, health status, disability rates, nutritional indicators, social and mental health indicators and so on. Being a developing country like India, there is a notable achievement in every aspect of health issues. At the same time, as many women are suffering from the health related issues and cannot get the proper treatment from the hospitals due to poor economic support they get. In a study states that the cost of accessing the health care services is high. At the same time the socio-economic profile of the country is also improving compare to a decade earlier. So, it is a study to know about the accessibility and affordability of the health insurance policies to the economically backward people. To assess the various factors influencing the people to get health insurance policies. To measure the practical difficulties faced by the people at the time of using the health insurance scheme. To understand the effectiveness and satisfaction of the government health insurance schemes. The area of the study is done in Nagapattinam district. Descriptive type of study is conducted to collect data from the population of above said district. It is estimated that 500 samples are collected from the women. Stratified random sampling is followed in this study. The data is analyzed by using suitable data analysis tools such as SPSS to get an accuracy of the result. Suggestions are given based on the findings.

*Keywords:* Health Insurance, Policy holders, socio-economic, government health insurance

ATTESTED

  
Dr. S. RAMABALAN, M.E., Ph.D.,  
PRINCIPAL  
E.G.S. Pillay Engineering College,  
Thethi, Nagore - 611 002,  
Nagapattinam (Dt) Tamil Nadu.



**A STUDY ON ORGANIZATIONAL EFFECTIVENESS OF  
ANCILLARY INDUSTRIES IN BHEL AT TRICHY**

**Mrs.B.Asha Daisy, Assistant Professor  
Department of Management Studies  
E.G.S.Pillay Engineering College, Nagapattinam-611002, Tamilnadu**

**Abstract:** Organizational effectiveness shows how to achieve the organizational goals in an effective manner. It is also expressing as an efficiency with which an association can meet its objectives. This means an organization produce the desired effect without any waste. The desired effect depends upon the goals of the organization. The main objectives of the study are to analyze the impact of organizational effectiveness. To examine the factors that increases the organizational effectiveness. The research design used in the study was descriptive research design. Both the primary data and secondary data were used for the study. The data was analyzed with the help of statistical tools and the results were interpreted.

**Keywords:** *organizational goals, association, desired effect, organizational effectiveness*

**A STUDY ON EMPLOYEE WELFARE MEASURES IN TRICHY  
AGRO INDUSTRY AT TRICHY**

**P.Pavithra, MBA  
Department of Management Studies  
E.G.S.Pillay Engineering College, Nagapattinam-611002, Tamilnadu**

**Abstract:** The paper entitled "A STUDY ON EMPLOYEE WELFARE MEASURES IN TRICHY AGRO INDUSTRY AT TRICHY". It aims to find the effectiveness of the employee practices by TRICHY AGRO INDUSTRY. The research has taken 110 samples for the total population. The primary data was collected through questionnaire methods using convenient sampling technique. The secondary data has been collected from books, journals and internet. The collected data has been technically analyzed by using the tools like percentage analysis, chi-square and correlation with the help of analyzed data findings and suggestions are made. The most of the respondents are agreed with the satisfaction working environment by the company, Suggestions are given for improving in the overall opinion, based on study result in the company by method of management techniques.

**Keywords:** *Growth of the company, Working environment*

ATTESTED



**Dr. S. RAMABALAN, M.E., Ph.D.,  
PRINCIPAL**

**E.G.S. Pillay Engineering College,  
Thethi, Nagore - 611 002,  
Nagapattinam (Dt) Tamil Nadu.**

**A STUDY ON EMPLOYEE PERCEPTION ABOUT ORGANIZATION  
CLIMATE AND CULTURE IN ADDISON & CO LIMITED AT  
IRUNGATUKOTAI, CHENNAI**

**T. Vijayalakshmi, MBA**  
Department of Management Studies  
E.G.S.Pillay Engineering College, Nagapattinam-611002, Tamilnadu

**Abstract:** The paper entitled "A study on employee perception about organization climate and culture in Addison & Co Limited at Irungatukotai, Chennai. The organizational climate and culture are the powerful tools that have tremendous effect on the morale, performance and job satisfaction of the employees in any organization. The main objectives are attitudes towards their relationship, effective leadership style in an organization, norms followed in a working environment, priority working time of an employee. The sample of 110 respondents has been taken for getting relevant information for the study through a questionnaire. The primary data are collected through the questionnaire. The secondary data are collected from the company records, journals, books and websites. The sample size is 110 respondents out of 250 populations. Samplings was selected by the method of simple random sampling. Analysis part was done by simple analysis technique (Percentage analysis) and Statistical analysis technique such as Chi-square, Correlation and Anova. The study provides some findings that were interrupted from the analysis of the collected data. The suggestions were given by the researcher which may help the company to know about the perception of an employee.

**Keywords:** Attitude, Effective leadership, Norms, Prioritization

**A STUDY ON WORKING CAPITAL MANAGEMENT IN SRI  
KAMALAMBIKA CO OPERATIVE URBAN BANK LTD AT  
THIRUVARUR**

**S.Sathishkumar, MBA**  
Department of Management Studies  
E.G.S.Pillay Engineering College, Nagapattinam-611002, Tamilnadu

**Abstract:** The paper entitled "A STUDY ON WORKING CAPITAL MANAGEMENT IN SRI KAMALAMBIKA CO OPERATIVE URBAN BANK LTD AT THIRUVARUR". Working capital management is the term of working capital refers to the amount of capital which is really available to banking. That is working capital is the difference between resources in cash or readily convertible into cash and organizational commitments for which cash will soon be required cash asset are resources which are in cash will soon be required cash asset are resources which are in cash will soon be converted in to cash in the ordinary

  
Dr. S. RAMABALAN, M.E., Ph.D.,  
PRINCIPAL  
E.G.S. Pillay Engineering College,  
Thethi, Nagore - 611 002.  
Nagapattinam (Dt) Tamil Nadu.

## A STUDY ON PERFORMANCE APPRAISAL IN VARIFAB ENGINEERING PRIVATE LIMITED AT CHENNAI

M.Roobhiya, MBA

Department of Management Studies  
E.G.S.Pillay Engineering College, Nagapattinam-611002, Tamilnadu

**Abstract:** The success of an organization depends on the employees and it is the human tendency to judging based on informal standards that can create lack of enthusiasm and impact the performance of the employee and in turn, the organization. Hence, it is essential that we set right standards to judge the performance of the employees. There used descriptive research design and simple random sampling technique. The primary data is collected through questionnaires from employee. The secondary data are collected from company records and website. Sample of 120 respondents have been taken for getting relevant information for the study through a questionnaires. The tools used for analysis are percentage analysis, chi-square, correlation and ANOVAs based on the information from the questionnaires, analysis, and interpretation were made, based on the analysis certain findings, suggestion and conclusion has made. From the findings it is interpreted that more than a half of the respondents were strongly motivated after performance appraisal.

**Keywords:** HR activities, standards, impact on production

## MATHEMATICAL MODELLING ON HEALTH DISORDERS AMONG WOMEN

<sup>1</sup>Dr.P.Jamuna Devi, <sup>2</sup>Dr.R.SophiaPorchelvi & <sup>3</sup>Dr.G.Sudha

<sup>1,2,&3</sup>Department of Mathematics

<sup>1,2,&3</sup>A.D.M College for Women (Autonomous), Nagapattinam

**Abstract:** Mathematical methods play an important role in dealing with real world problems and by using the same, we analyze the women facing the high burden of nutritional health disorders, epidemic diseases and ground water vulnerability. This paper presents some of the methods commonly used by researchers to explain the challenges that need to be addressed and propose some tools for analysis and exemplifies when possible with results for studies conducted in surveyed region. In this Paper, various health issues of Women in Delta region is analyzed using Mathematical Models like fuzzy Mathematical models, Differential Equation Models, Multi-Objective Transportation Models, Multivariate Statistical models to analyze the risk of existing challenges of nutritional health disorders faced by Women and to assess the effect of various socio-economic and demographic factors of anaemia and hypotension of the womanhood by using time dependent matrices.

**Keywords:** Ground water vulnerability, health disorders, Transportation Models

ATTESTED  
11  
Dr. S. RAMABALAN, M.E., Ph.D.,  
PRINCIPAL  
E.G.S. Pillay Engineering College,  
Thethi, Nagore - 611 002.  
Nagapattinam (Dt) Tamil Nadu.



between management and employee by the company. Data analysis has been done with statistical tools used in chi-square test, and correlation.

*Keywords: Leadership style, satisfaction of employees*

## **IMPLEMENTING HUMAN RESOURCE MANAGEMENT PRACTICES IN AGRICULTURE**

**Mr.S.Sakthi Kamal Nathan, Assistant Professor**

**Department of Management Studies**

**E.G.S.Pillay Engineering College, Nagapattinam-611002, Tamilnadu**

**Abstract:** Over the past century, there has been an evolution in the concept of "human resources" a term that was not actually used in its current form until the mid-1950s when economist and Yale professor E. Wight Bakke published a report entitled "The Human Resources Function." Implementing Human Resource practices into Farming Agriculture has been following since the late 2000s. Many people found it successful, but a few struggled to follow. Few practices like the wage of coolies can be given on a monthly basis instead of daily waging system, remuneration, rewards and recognition system can be followed. The result of the study indicates that to prepare the agricultural workforce to meet the new challenges we need a more educated and skilled workforce competent enough to understand both the technical and the social development at a global level. Countries' historic and social construction have great influence on the development of agricultural education and training and the way the phenomenon of globalization and its role is understood and experienced in agricultural sector.

*Keywords: Waging system, remuneration, recognition system*

**ATTESTED**

  
**Dr. S. RAMABALAN, M.E., Ph.D.,  
PRINCIPAL**  
E.G.S. Pillay Engineering College,  
Thethi, Nagore - 611 002,  
Nagapattinam (Dt) Tamil Nadu.



# **E.G.S. PILLAY ENGINEERING COLLEGE**



**NAGAPATTINAM - 611 002**

An ISO 9001:2008 Certified Institution (Approved by AICTE, New Delhi)

Affiliated to Anna University, Chennai

Accredited by NAAC with "A" Grade



**DEPARTMENT OF MANAGEMENT STUDIES**

## **ONE DAY GUEST LECTURE**

**On**

**PREPARATION OF A GOOD JOURNAL ARTICLE**

**(18.01.2019)**

*Organized by*

**DEPARTMENT OF MANAGEMENT  
STUDIES**

***Venue: Board Room  
SJ Block***

**ATTESTED**

  
**Dr. S. RAMABALAN, M.E., Ph.D.,  
PRINCIPAL**

**E.G.S. Pillay Engineering College,**

**Thethi, Nagore - 611 002.**

**Nagapattinam (Dt) Tamil Nadu.**

# E.G.S. PILLAY ENGINEERING COLLEGE



**NAGAPATTINAM - 611 002**

An ISO 9001:2008 Certified Institution (Approved by AICTE, New Delhi)

Affiliated to Anna University, Chennai

Accredited by NAAC with "A" Grade



**DEPARTMENT OF MANAGEMENT STUDIES**

## **"PREPARATION OF A GOOD JOURNAL ARTICLE"**

**ORGANIZED BY** : Dr.R.Karthi, Director/ Department of Management Studies

**SUPPORTED BY** : Dr.B.Asha Daisy, Mr. S. Sakthi Kamal Nathan, P. Balaishwarya,  
Assistant Professors, Department of Management Studies

**GUEST SPEAKER** : Dr. K. Mathiyazhagan, Associate Professor, the Department of  
Mechanical Engineering, Amity University, Noida, UP

**CONDUCTED ON** : 18-01-2019

**ATTESTED**

**Dr. S. RAMABALAN, M.E., Ph.D.,**  
**PRINCIPAL**

E.G.S. Pillay Engineering College,  
Thethi, Nagore - 611 002.  
Nagapattinam (Dt) Tamil Nadu.

## Contents

| S. No | Description              |
|-------|--------------------------|
| 1     | Approval Letter          |
| 2     | Acceptance Letter        |
| 3     | Event Circular           |
| 4     | Profile of Guest Speaker |
| 5     | Event Invitation         |
| 6     | Participants Name List   |
| 7     | Synopsis of the Event    |
| 8     | Event Photos             |
| 9     | Sample Feedback          |

ATTESTED

  
Dr. S. RAMABALAN, M.E., Ph.D.,  
PRINCIPAL  
E.G.S. Pillay Engineering College,  
Thethi, Nagore - 611 002.  
Nagapattinam (Dt) Tamil Nadu.

**E.G.S. PILLAY ENGINEERING COLLEGE(AUTONOMOUS) NAGAPATTINAM**

**DEPARTMENT OF MANAGEMENT STUDIES**

**CIRCULAR**

**Date: 11-01-2019**

This is to inform that the Department of Management Studies is organizing a program for faculty members on 18-01-2019 at 10.00 am in Board Room SJ Block. Dr. K. Mathiyazhagan, Associate Professor, the Department of Mechanical Engineering, Amity University, Noida, UP. He will share his knowledge with us about "Preparation for Good Journals". So interested faculty members are asked to participate in this programme.

  
**Director/MBA**

**Dr. R. KARTHI**  
Director  
Department of Management Studies  
E.G.S. Pillay Engineering College  
Nagapattinam - 611 002.

**ATTESTED**

  
**Dr. S. RAMABALAN, M.E., Ph.D.,**  
**PRINCIPAL**  
E.G.S. Pillay Engineering College,  
Thethi, Nagore - 611 002.  
Nagapattinam (Dt) Tamil Nadu.



**E.G.S. PILLAY ENGINEERING COLLEGE (AUTONOMOUS)**

**Department of management Studies**

Date: 11-01-2019

**Submitted to Principal**

Sub: Requesting permission for conducting on online workshop- Reg

The department of MBA has planned to conduct a Guest lecture "Preparation of a Good Journal Article" on 18-01-2019. kindly grant the permission to conduct the session.

Yours faithfully



**Dr. R. KARTHI**  
Director

Department of Management Studies  
E.G.S. Pillay Engineering College  
Nagapattinam - 611 002.

**ATTESTED**



**Dr. S. RAMABALAN, M.E., Ph.D.,**  
**PRINCIPAL**  
E.G.S. Pillay Engineering College,  
Thethi, Nagore - 611 002.  
Nagapattinam (Dt) Tamil Nadu.

## SUMMARY OF THE PROGRAMME

Initial research findings are presented on the preliminary stages of a guest lecturing program currently being implemented by our department of management studies. This lecture provides guidelines for preparing a good journal article. Guest lecturer gives the tenor for writing a academic journal article.

- 1) Have a strategy, make a plan.
- 2) Analyze writing in journals in your field.
- 3) Do an outline and just write.
- 4) Get feedback from start to finish.
- 5) Set specific writing goals and sub-goals.
- 6) Write with others.
- 7) Do a warm up before you write.
- 8) Analyze reviewer's feedback on your submission
- 9) Be persistent, thick- skinned and resilient
- 10) Take care of yourself

ATTESTED  
  
Dr. S. RAMABALAN, M.E., Ph.D.,  
PRINCIPAL  
E.G.S. Pillay Engineering College,  
Thetti, Nagore - 611 002,  
Nagapattinam (Dt) Tamil Nadu.

## OBJECTIVES & OUTCOMES

### *LEARNING OBJECTIVES*

---

- Associate the major sections of a journal article.
- Gain a deeper knowledge and understanding of journal article.
- Report research findings in written and verbal forms

### *LEARNING OUTCOMES*

---

At the end of this lecture, the students should be able to:

- Understand some basic concepts of journal article and its types
- Identify appropriate article topics
- Select and define appropriate research problem and parameters
- Write an effective & good journal article.

ATTESTED

  
Dr. S. RAMABALAN, M.E., Ph.D.,  
PRINCIPAL

E.G.S. Pillay Engineering College,  
Thethi, Nagore - 611 002.  
Nagapattinam (Dt) Tamil Nadu.

## ***SPEAKER PROFILE***



Dr. K. Mathiyazhagan is currently working as an Associate Professor in the Department of Mechanical Engineering, Amity University, Noida, UP, India. He did his Ph.D in the Department of Production Engineering, National Institute of Technology – Tiruchirappalli, Tamilnadu. In addition to the Ph.D work, he went to the University of Southern Denmark, Denmark” four months as a visiting research scholar. He has more than 50 International publications Cumulative impact factor of (SCI/SSCI) 48.71 and one international book chapter in the Taylor and Francis. Recently one of his papers awarded as Excellence Citation Award by Emerald Publisher Ltd. Also he is guest editor of many special issues in International journals.

### **Skills and Expertise**

- Operations Management
- Lean Manufacturing
- SCM
- Production/Operations Management
- Lean Management
- Supply Chain
- Sustainable Supply Management
- Supply Chain Management
- Environmental Performance
- Analytic Hierarchy Process
- Multiple-Criteria Decision Analysis
- Green Supply Chain Management
- Sustainable Supply Chain Management
- Sustainable Manufacturing
- Public distribution system

**ATTESTED**  
  
**Dr. S. RAMABALAN, M.E., Ph.D.,**  
**PRINCIPAL**  
E.G.S. Pillay Engineering College,  
Thethi, Nagore - 611 002.  
Nagapattinam (Dt) Tamil Nadu.



**Event Invitation:**

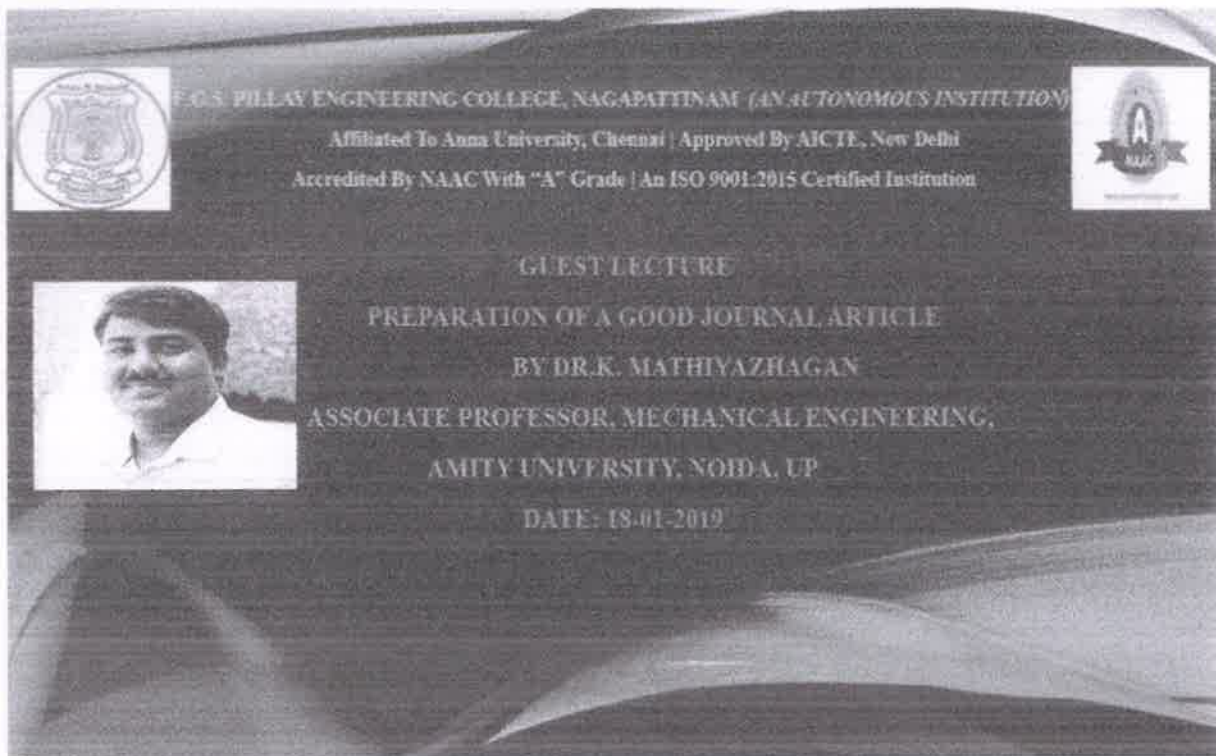

E.G.S. PILLAY ENGINEERING COLLEGE, NAGAPATTINAM (AN AUTONOMOUS INSTITUTION)

Affiliated To Anna University, Chennai | Approved By AICTE, New Delhi  
Accredited By NAAC With "A" Grade | An ISO 9001:2015 Certified Institution

GUEST LECTURE  
PREPARATION OF A GOOD JOURNAL ARTICLE  
BY DR. K. MATHIYAZHAGAN  
ASSOCIATE PROFESSOR, MECHANICAL ENGINEERING,  
AMITY UNIVERSITY, NOIDA, UP  
DATE: 18.01.2019

ATTESTED

  
Dr. S. RAMABALAN, M.E., Ph.D.,  
PRINCIPAL

E.G.S. Pillay Engineering College,  
Thethi, Nagore - 611 002.  
Nagapattinam (Dt) Tamil Nadu.

## Synopsis of the event:

General structure for writing an academic journal article

**Title:** The title of your article is one of the first indicators readers will get of your research and concepts.

**Keywords.** Keywords are an essential part of producing a journal article. Abstract, Introduction. Main body, Conclusion.

References and citations.

Nearly all journal articles are divided into the following major sections: abstract, introduction, methods, results, discussion, and references. Usually the sections are labeled as such, although often the introduction (and sometimes the abstract) is not labeled. Sometimes alternative section titles are used.

The first step is to determine which type of paper is most appropriate for your work and what you want to achieve. The following list contains the most important, usually peer-reviewed article types in the natural sciences:

Full original research papers disseminate completed research findings. On average this type of paper is 8-10 pages long, contains five figures, and 25-30 references. Full original research papers are an important part of the process when developing your career.

Review papers present a critical synthesis of a specific research topic. These papers are usually much longer than original papers and will contain numerous references. More often than not, they will be commissioned by journal editors. Reviews present an excellent way to solidify your research career.

Letters, Rapid or Short Communications are often published for the quick and early communication of significant and original advances. They are much shorter than full articles and usually limited in length by the journal. Journals specifically dedicated to short communications or letters are also published in some fields. In these the authors can present short preliminary findings before developing a full-length paper.

ATTESTED  
  
Dr. S. RAMABALAN, M.E., Ph.D.,  
PRINCIPAL  
E.G.S. Pillay Engineering College,  
Thenni, Nagore - 611 002.  
Nagapattinam (Dt) Tamil Nadu

## Participant List:

| S.NO | FACULTY NAME               | DESIGNATION         |
|------|----------------------------|---------------------|
| 1    | Dr.R.Karthi                | Director/MBA        |
| 2    | Dr.S.Chandrasekar          | Professor           |
| 3    | Mohan kumar. R             | Associate Professor |
| 4    | Dr.B.Asha Daisy            | Assistant Professor |
| 5    | Mr.S.Sakthi Kamal Nathan   | Assistant Professor |
| 6    | Mr.I.Arulprakash           | Assistant Professor |
| 7    | Mr.S.Mohamed Naina Maricar | Assistant Professor |
| 8    | Vinotha.P                  | Assistant Professor |
| 9    | Aarthi.L                   | Assistant Professor |
| 10   | Sayee Sudha. M             | Assistant Professor |
| 11   | Sowarna Lashmi.A           | Assistant Professor |
| 12   | Mrs A.Umadevi              | Assistant Professor |
| 13   | R. Deepa                   | Assistant Professor |
| 14   | A.Kavitha                  | Assistant Professor |
| 15   | Tharani                    | Assistant Professor |
| 16   | S.Malathi                  | Assistant Professor |
| 17   | R.Arulraj                  | Assistant Professor |
| 18   | A.Poonghuzhali             | Assistant Professor |
| 19   | G. Rajarajan               | Assistant Professor |

**ATTESTED**  
  
**Dr. S. RAMABALAN, M.E., Ph.D.,**  
**PRINCIPAL**  
E.C.S. Pillay Engineering College,  
Theethi, Nagore - 611 002.  
Nagapattinam (Dt) Tamil Nadu.

**E.G.S. PILLAY ENGINEERING COLLEGE (AUTONOMOUS)**

**Department of management Studies**

**One-day Guest lecture "Preparation of Good Journal Article"**

**18-01-2019**

**Attendance**

| S.No | Name of Faculty             | Department | College Name | Designation | Signature        |
|------|-----------------------------|------------|--------------|-------------|------------------|
| 1.   | N. Sayee Sudha              | HBA        | EGSPEC       | AP          | M. Sayee Sudha   |
| 2.   | L. Anithi                   | MBA        | EGSPEC       | AP          | L. Anithi        |
| 3.   | R. Deepa                    | SH         | EGSPEC       | AP          | R. Deepa         |
| 4.   | S. Malothi                  | BBA        | EGSPAC       | AP          | S. Malothi       |
| 5.   | S. Sakti Kamel Nathan       | MBA        | EGSPEC       | AP          | S. Sakti         |
| 6.   | A. Poongudali               | MBA        | EGSPEC       | AP          | A. Poongudali    |
| 7.   | I. Arul Prakash             | MBA        | EGSPEC       | AP          | I. Arul Prakash  |
| 8.   | B. Asha Daisy               | MBA        | EGSPEC       | AP          | B. Asha Daisy    |
| 9.   | R. Arul Raj                 | MBA        | EGSPAC       | AP          | R. Arul Raj      |
| 10.  | A. Sumanalashmi             | MBA        | EGSPEC       | AP          | A. Sumanalashmi  |
| 11.  | P. Vinodh                   | HBA        | EGSPEC       | AP          | P. Vinodh        |
| 12.  | G. Rajarajan                | MBA        | EGSPAC       | AP          | G. Rajarajan     |
| 13.  | R. Mohan Kumar              | MBA        | EGSPEC       | AP          | R. Mohan Kumar   |
| 14.  | A. Umadevi                  | MBA        | EGSPEC       | AP          | A. Umadevi       |
| 15.  | S. Mohamed Naina<br>Mavilan | MBA        | EGSPEC       | AP          | S. Mohamed Naina |

**ATTESTED**

**Dr. S. RAMABALAN, M.E., Ph.D.,  
PRINCIPAL**

E.G.S. Pillay Engineering College,  
Thethi, Nagore - 611 002.  
Nagapattinam (Dt) Tamil Nadu.



## Guest Lecture Feedback Form

We would appreciate if you could take a few minutes to share your opinions with us so we can serve you better.

Title: PREPARATION OF A GOOD JOURNAL ARTICLE  
Date: 18-01-2019 Speaker: DR. K. MATHIAZHAGAN

- |  |   |   |   |     |     |
|--|---|---|---|-----|-----|
| 1. The content was as described in publicity materials                               | 1 | 2 | 3 | 4   | 5 ✓ |
| 2. The lecture was applicable to my carrer   | 1 | 2 | 3 | 4   | 5 ✓ |
| 3. I will recommend this lecture to other conservators                               | 1 | 2 | 3 | 4 ✓ | 5   |
| 4. The program was well paced within the allotted time                               | 1 | 2 | 3 | 4   | 5 ✓ |
| 5. The speaker was a good communicator   | 1 | 2 | 3 | 4   | 5 ✓ |
| 6. The material was presented in an organized manner                                 | 1 | 2 | 3 | 4   | 5 ✓ |
| 7. The speaker was knowledgeable on the topic  | 1 | 2 | 3 | 4   | 5 ✓ |
| 8. I would be interested in attending a follow-up, more lecture on this same subject | 1 | 2 | 3 | 4   | 5 ✓ |

9. Given the topic, was this lecture:  a. Too short  b. Right length  c. Too long

10. In your opinion, was this lecture:  a. Introductory  b. Intermediate  c. Advanced

11. What did you most appreciate/enjoy/think was best about the lecture ? Any suggestions for improvement?

Thank you!

Please return this form to the coordinator at the end

ATTESTED

  
Dr. S. RAMABALAN, M.E., Ph.D.,  
PRINCIPAL

E.G.S. Pillay Engineering College,  
Thethi, Nagore - 611 002.  
Nagapattinam (Dt) Tamil Nadu.

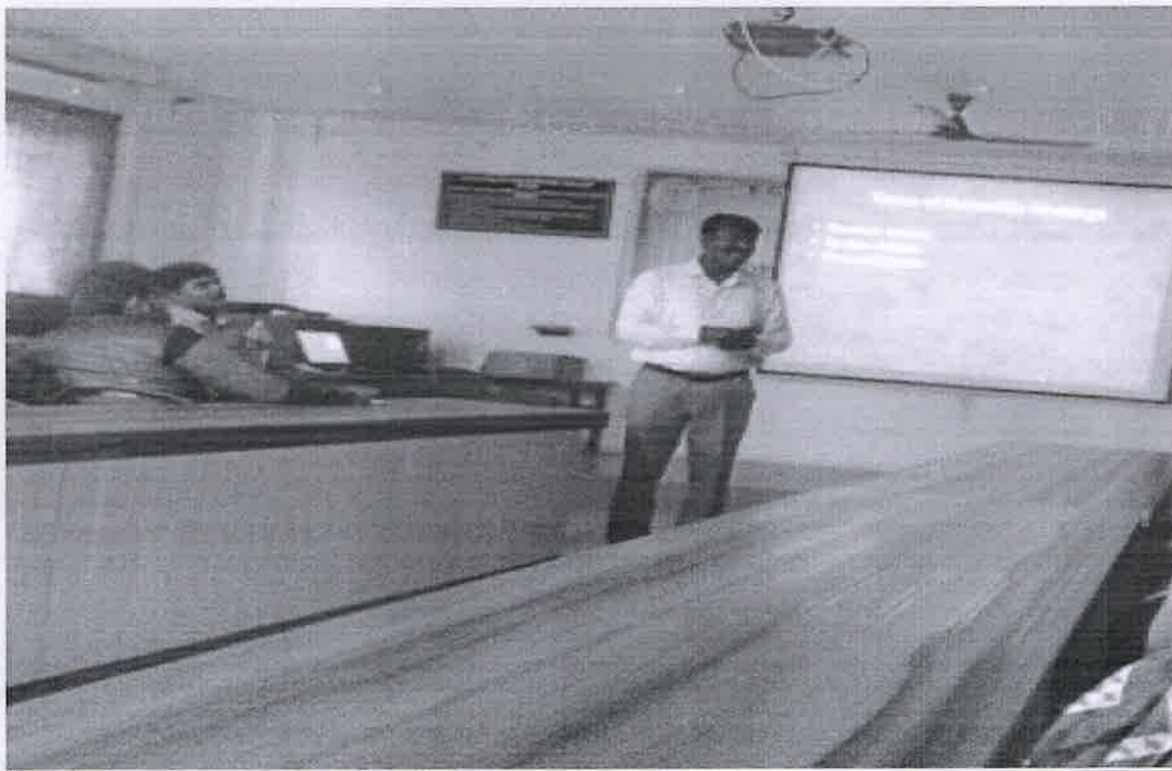

ATTESTED

**Dr. S. RAMABALAN, M.E., Ph.D.,**  
**PRINCIPAL**

**E.G.S. Pillay Engineering College,**

**Theilai, Nagore - 611 002,**

**Nagapattinam (Dt) Tamil Nadu,**



# E.G.S. PILLAY

## Group of Institutions

ENGINEERING | ARTS & SCIENCE | POLYTECHNIC | PHARMACY | B.ED., | INTERNATIONAL SCHOOL (CBSE)  
Nagapattinam-611 002.



# Certificate of Appreciation

*This certificate is presented to*

*Dr. k. Mathiyazhagan*

*in grateful recognition and sincere appreciation for sharing his valuable time and knowledge as Resource Speaker during the guest lecture programme on Preparation of a Good Journal articles on 18-01-2019 at Department of Management Studies, E.G.S. Pillay Engineering College (Autonomous),*

*Nagapattinam*

**Dr.R.Karthi**

**Director/MBA**

**Dr.S.Ramabalan**

**Principal**

ATTESTED

**Dr. S. RAMABALAN, M.E., Ph.D.,**  
**PRINCIPAL**  
E.G.S. Pillay Engineering College,  
Thethi, Nagore - 611 002.  
Nagapattinam (Dt) Tamil Nadu.



**E.G.S.PILLAY ENGINEERING COLLEGE,[AUTONOMOUS]NAGAPATTINAM – 611002**

**Approved by AICTE,New Delhi | Affiliated to Anna University,Chennai**

**Accredited by NAAC with 'A' Grade | An ISO 9001:2015 Certified Institution**

**Nagapattinam – 611001 Tamil Nadu India**

**Ph: 04365 -251112 / 251114 | E-mail:enquiries@egspec.org | Website : [WWW.egspec.org](http://WWW.egspec.org)**

**Two Days Faculty Development Program  
On  
Web Application Development**

**Using J2EE**

***1<sup>st</sup> & 2<sup>nd</sup> June 2019***

***(Venue: PG Conference Hall ;Time :09.30 A.M)***

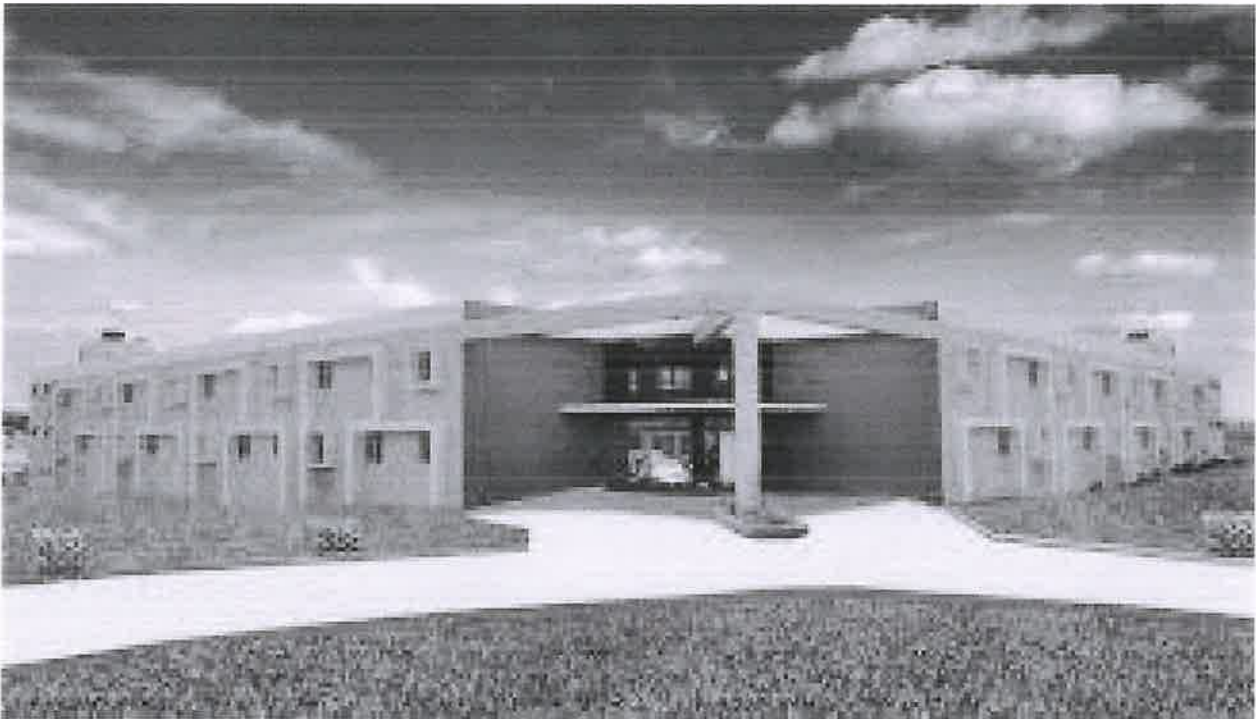

**Coordinators**

- 1. Mrs. A.Hema.Asst.Prof /MCA**
- 2. Ms. N.Ilakkiya, Asst.Prof/MCA**

**Convener**

**(Dr. J.Vanitha, Professor /MCA)**

**ATTESTED**

  
**Dr. S. RAMABALAN, M.E., Ph.D.,  
PRINCIPAL**

**E.G.S. Pillay Engineering College,  
Thethi, Nagore - 611 002.  
Nagapattinam (Dt) Tamil Nadu.**



**E.G.S.PILLAY ENGINEERING COLLEGE,[AUTONOMOUS]NAGAPATTINAM – 611002**

**Approved by AICTE,New Delhi | Affiliated to Anna University,Chennai**

**Accredited by NAAC with 'A' Grade | An ISO 9001:2015 Certified Institution**

**Nagapattinam – 611001 Tamil Nadu India**

**Ph:04365 -251112 / 251114 | E-mail:enquiries@egspec.org | Website : [WWW.egspec.org](http://WWW.egspec.org)**

**Two Days Faculty Development Program  
On  
Web Application Development  
Using J2EE**

***1<sup>st</sup> & 2<sup>nd</sup> June 2019***

***(Venue: PG Conference Hall ;Time :09.30 A.M)***

**Contents**

| <b>S.No</b> | <b>Details</b>                   | <b>Page No</b> |
|-------------|----------------------------------|----------------|
| 1.          | About the College and Department | 1              |
| 2.          | Invitation                       | 3              |
| 3.          | Brochure                         | 4              |
| 4.          | Agenda                           | 6              |
| 5.          | Permission Letter                | 7              |
| 6.          | Circular                         | 8              |
| 7.          | Session Details                  | 9              |
| 8.          | Resource Person Profile          | 10             |
| 9.          | Participants List                | 11             |
| 10.         | Report                           | 13             |
| 11.         | Feedback Form                    | 14             |
| 12.         | Sample Photos                    | 15             |
| 13.         | Sample Program                   | 17             |
| 14.         | Sample Certificate               | 21             |

**ATTESTED**



**Dr. S. RAMABALAN, M.E., Ph.D.,  
PRINCIPAL**

**E.G.S. Pillay Engineering College,  
Thethi, Nagore - 611 002.  
Nagapattinam (Dt) Tamil Nadu.**

**E.G.S.PILLAY ENGINEERING COLLEGE,[AUTONOMOUS]NAGAPATTINAM – 611002**

**Approved by AICTE,New Delhi |Affiliated to Anna University,Chennai**

**Accredited by NAAC with 'A' Grade | An ISO 9001:2015 Certified Institution**

**Nagapattinam – 611001 Tamil Nadu India**

**Ph:04365 -251112 / 251114 | E-mail:enquiries@egspec.org | Website : [WWW.egspec.org](http://WWW.egspec.org)**

**Two Days Faculty Development Program  
On  
Web Application Development**

**Using J2EE**

**1<sup>st</sup> & 2<sup>nd</sup> June 2019**

**(Venue: PG Seminar Hall; Time: 09.30 A.M)**

**Organized by**

**E.G.S. Pillay Engineering College, Nagapattinam- 611002**

**[www.egspec.org](http://www.egspec.org)**



**ABOUT THE INSTITUTION**

E G S Pillay Engineering College is one of the pioneering non - grant engineering Colleges in the State. It was established by the E G S Pillay & Sons Educational & Charitable Trust, Nagapattinam in the year 1995 with the sanction of the Government of Tamilnadu, approval of the All India Council for Technical Education, New Delhi and affiliation to Bharathidasan University, Tiruchirapalli. Its courses are affiliated to Anna University, Chennai from 2002 and the degrees are awarded by Anna University, as per the Government Orders. The College has earned the reputation of being one of the most preferred colleges by the students and parents all these years. Known for its excellent infrastructure and facilities for learning, the outstanding non - grant engineering college has registered impressive performance consistently. A gate-way to success, the college has now set on long-range planning to enlarge and enrich its programs and activities to empower the youth who aspire to become successful Engineers, Scientists and Managers. The College has earned the reputation of being one of the most preferred colleges by the students and parents all these years. Known for its excellent infrastructure and facilities for learning, the outstanding non-grant engineering

**ATTESTED**  
**Dr. S. RAMABAIAN, M.E., Ph.D.**  
**PRINCIPAL**  
**E.G.S. Pillay Engineering College,**  
**Thethi, Nagore - 611 002.**  
**Nagapattinam (Dt) Tamil Nadu.**

college has registered impressive performance consistently. A gate-way to success, the college has now set on long-range planning to enlarge and enrich its programs and activities to empower the youth who aspire to become successful Engineers, Scientists and Managers. The college approved by AICTE-New Delhi, affiliated to Anna University-Chennai, recognized by UGC Act 2(f) &12(B) and accredited by NAAC with 'A' Grade and NBA for three Departments (B.E-CSE/EEE/MECH).

## **DEPARTMENT PROFILE**

The department of computer applications focuses on making industry ready IT professionals by imparting quality computer education along with excellent interpersonal skills. It offers 3 years Full time MCA course to the students. Started in the year of 2001, the course was approved by Bharathidasan University, Trichirappalli. In 2003, Anna University, Chennai recognized and approved the course. The current intake of students is 60 per academic year.

## **HOW TO APPLY**

Prospective participants have to fill the registration form and send the scanned copy to the coordinator through the E-Mail: [egspecmcafdp18@gmail.com](mailto:egspecmcafdp18@gmail.com) before the last date (29.05.2019).

Admission to the FDP will be on First Come, First Served basis.

## **NO REGISTRATION FEES**

Registration kit, Certificate and lunch will be provided to all the Participants.

## **TARGET GROUP**

The FDP is intended to provide opportunity to Faculty Members of Engineering/ Arts & Science / Polytechnic, Research Scholars and Students to upgrade their knowledge in Open Source Tools.

**ATTESTED**



**Dr. S. RAMABALAN, M.E., Ph.D.,  
PRINCIPAL**

**E.G.S. Pillay Engineering College,  
Thethi, Nagore - 611 002.  
Nagapattinam (Dt) Tamil Nadu.**

**E.G.S.PILLAY ENGINEERING COLLEGE,[AUTONOMOUS]NAGAPATTINAM – 611002**

Approved by AICTE,New Delhi | Affiliated to Anna University,Chennai

Accredited by NAAC with 'A' Grade | An ISO 9001:2015 Certified Institution

Nagapattinam – 611001 Tamil Nadu India

Ph:04365 -251112 / 251114 | E-mail:enquiries@egspec.org | Website : [WWW.egspec.org](http://WWW.egspec.org)

*Cordially Invites you for the*

**Two Days Faculty Development Program  
On  
Web Application Development  
Using J2EE  
1<sup>st</sup> & 2<sup>nd</sup> June 2019**

*(Venue: PG Conference Hall ;Time :09.30 A.M)*

**CHIEF GUEST**

*Shri S.Paramesvara,M.Com.,FCCA.,(London)  
Secretary, E.G.S. Pillay Group of Institutions*

Resource Person  
Mrs.A.Suganthi  
Assistant Professor /MCA , AVCCE, Mannampandal, Mayiladuthurai.

Organized by

E.G.S. Pillay Engineering College, Nagapattinam- 611002  
[www.egspec.org](http://www.egspec.org)

*Will preside over the function*

*Dr.S.Ramabalan,  
Principal,EGSPEC*

*Mrs.J.Vanitha,  
HOD/MCA*

**ATTESTED**  
  
**Dr. S. RAMABALAN, M.E., Ph.D.,  
PRINCIPAL**  
E.G.S. Pillay Engineering College,  
Thethi, Nagore - 611 002.  
Nagapattinam (Dt) Tamil Nadu.





**E.G.S. Pillay Engineering College,  
Nagapattinam – 611002**

Approved by AICTE, New Delhi | Affiliated to Anna University, Chennai  
Accredited by NAAC with 'A' Grade | An ISO 9001: 2015 Certified Institution  
NAGAPATTINAM – 611002 TAMIL NADU INDIA  
Ph: 04365-251122 / 251114 | E-mail: [egs@egscollege.org](mailto:egs@egscollege.org) | Website: [www.egscollege.org](http://www.egscollege.org)

**Two Days Faculty Development Program**

## Web Application Development Using J2EE

**1<sup>st</sup> & 2<sup>nd</sup> June 2019**

Organized by

**E.G.S. Pillay Engineering College,  
Nagapattinam- 611002  
[www.egspec.org](http://www.egspec.org)**



### ABOUT THE INSTITUTION

E G S Pillay Engineering College is one of the pioneering non - grant engineering Colleges in the

State. It was established by the E G S Pillay & Sons Educational & Charitable Trust, Nagapattinam in the year 1995 with the sanction of the Government of Tamilnadu, approval of the All India Council for Technical Education, New Delhi and affiliation to Bharathidasan University, Tiruchirapalli. Its courses are affiliated to Anna University, Chennai from 2002 and the degrees are awarded by Anna University, as per the Government Orders. The College has earned the reputation of being one of the most preferred colleges by the students and parents all these years. Known for its excellent infrastructure and facilities for learning, the outstanding non - grant engineering college has registered impressive performance consistently. A gate-way to success, the college has now set on long-range planning to enlarge and enrich its programs and activities to empower the youth who aspire to become successful Engineers, Scientists and Managers. The College has earned the reputation of being one of the most preferred colleges by the students and parents all these years. Known for its excellent infrastructure and facilities for learning, the outstanding non-grant engineering college has registered impressive performance consistently. A gate-way to success, the college has now set on long-range planning to enlarge and enrich its programs and activities to empower the youth who aspire to become successful Engineers, Scientists and Managers. The college approved by AICTE-New Delhi, affiliated to Anna University-Chennai, recognized by UGC Act 2(f) & 12(B) and accredited by NAAC with 'A' Grade and NBA for three Departments (B.E-CSE/EEE/MECH).

### DEPARTMENT PROFILE:

The department of computer applications focuses on making industry ready IT professionals by imparting quality computer education along with excellent interpersonal skills. It offers 3 years Full time MCA course to the students. Started in the year of 2001, the course was approved by Bharathidasan University, Trichirappalli. In 2003, Anna University, Chennai recognized and approved the course. The current intake of students is 60 per academic year.

### THEME OF THE FDP:

- To understand and describe the need for Data Center Virtualization
- To provide an overview of the challenges that vSphere is intended to resolve
- To discuss the features of VMware vSphere

### HOW TO APPLY:

Prospective participants have to fill the registration form and send the scanned copy to the coordinator through the E-Mail: [egspecmcafdp18@gmail.com](mailto:egspecmcafdp18@gmail.com) before the last date (27.04.2018).

Admission to the FDP will be on *First Come, First Served* basis.

### NO REGISTRATION FEES FOR THE FDP

Registration kit, Certificate and lunch will be provided to all the Participants.

### TARGET GROUP

Attending this Faculty development program will benefit for Faculty Members.

**ATTESTED**

**Dr. S. RAMABALAN, M.E., Ph.D.,  
PRINCIPAL**

**E.G.S. Pillay Engineering College,  
Thethi, Nagore - 611 002.  
Nagapattinam (Dt) Tamil Nadu.**



**E.G.S. Pillay Engineering College,  
Nagapattinam - 611002**

Approved by AICTE, New Delhi; Affiliated to Anna University, Chennai.  
Accredited by AACSB with A Grade (An ISO 9001:2008 Certified Institution)  
NAGAPATTINAM - 611002 TAMIL NADU INDIA  
Ph: 0466-2301211, 2301214; E-mail: [naec@naec.org](mailto:naec@naec.org); Website: [www.naec.org](http://www.naec.org)

**Two Days Faculty Development Program  
On  
Web Application Development  
Using J2EE  
1<sup>st</sup> & 2<sup>nd</sup> June 2019  
(Venue: PGB 209; Time :09.30 A.M)**

**ORGANIZING COMMITTEE**

**CHIEF PATRONS**

*Mrs. Jathamani G.S. Pillay,  
Chairman.  
Shri. S. Paramesvaran, M.Com., FCCM(London),  
Secretary.*

**PATRONS**

*Dr. S. Ramabalan, M.E., Ph.D.,  
Principal.  
Dr. V. Mohan, M.E., Ph.D.,  
Academic Director.  
Dr. M.K. Mishra, M.Sc.M.Phil., Ph.D.,  
Director/MCA.  
Dr. M. Chinnadurai, M.E., Ph.D.  
Professor/CSE*

**CONVENER**

*Mrs. J. Vanitha, MCA., M.Phil., (Ph.D.)  
Associate Professor/MCA*

**MEMBERS**

*Mrs. A. Hema, MCA, M.Phil.,  
Assistant Professor/MCA  
Ms. N. Hakkija, MCA.,  
Assistant Professor/MCA*

**SESSION DETAILS**

| Date/<br>Session | I<br>Session<br>10.00<br>a.m. to<br>11.30<br>a.m.   | II<br>Session<br>11.45<br>a.m. to<br>01.00<br>p.m.                         | III<br>Session<br>01.20<br>p.m. to<br>03.00<br>p.m.   | IV<br>Session<br>03.15<br>p.m. to<br>04.30<br>p.m.  |
|------------------|---|--|---|---|
| 01.06.20<br>19   | Module<br>1:<br>Introduc-<br>tion to<br>Web<br>Applicati-<br>on<br>Develop-<br>ment   | Module<br>2:<br>J2EE<br>Architec-<br>ture and<br>their<br>Component<br>s   | Module<br>3:<br>Develop-<br>ing<br>Web<br>Applicati-<br>on with<br>J2EE<br>Container<br>s   | Module<br>4:<br>MVC<br>Frame-<br>work for<br>creating<br>modern<br>java web<br>Applicati-<br>on                       |
| 02.06.20<br>19   | Module<br>5:<br>Under-<br>standing<br>Servlets<br>through<br>code and<br>JSPs<br>for<br>creating<br>dynamic<br>web<br>content | Module<br>6:<br>Servlets<br>Tool<br>with an<br>example<br>Applicati-<br>on | Module<br>7:<br>Creating<br>using<br>JSP<br>Concepts<br>and<br>Develop-<br>ing web<br>applicati-<br>ons with<br>JSP<br>with<br>JSP<br>JSP | Module<br>8:<br>Develop-<br>ing<br>applicati-<br>on with<br>JSP<br>applicati-<br>on by<br>using<br>JSP<br>with<br>JSP |

**Resource Persons:**

***Mrs. A.Suganthi***  
***Assistant Professor***  
***Department of MCA***  
***AVCCE, Mannampandal***  
***Mayilsaduthurai***

*Mrs. A.Hema, MCA, M.Phil.,  
Assistant Professor/MCA,  
E.G.S. Pillay Engineering College,  
Nagapattinam.*

*Ms. N.Hakkija, M.C.A.,  
Assistant Professor (MCA,  
E.G.S. Pillay Engineering College,  
Nagapattinam.*



**E.G.S. Pillay Engineering College,  
Nagapattinam - 611002**

Approved by AICTE, New Delhi; Affiliated to Anna University, Chennai.  
Accredited by AACSB with A Grade (An ISO 9001:2008 Certified Institution)  
NAGAPATTINAM - 611002 TAMIL NADU INDIA  
Ph: 0466-2301211, 2301214; E-mail: [naec@naec.org](mailto:naec@naec.org); Website: [www.naec.org](http://www.naec.org)

**Two Days Faculty Development Program  
On  
Web Application Development  
Using J2EE  
1<sup>st</sup> & 2<sup>nd</sup> June 2019  
Registration Form**

Name (In Block letters):

College: .....

Department: .....

Address: .....

Pin: .....

Email: .....

Mobile no: .....

**Declaration**

I, ..... agree to abide by the  
rules and regulation governing the FDP  
programme. The information provided herewith is  
true to the best of my knowledge

Place:

Date:

Signature of the participant

Head of the Dept / Institution

Signature with Seal

**ATTESTED**

**Dr. S. RAMABALAN, M.E., Ph.D.,  
PRINCIPAL**

**E.G.S. Pillay Engineering College,  
Thethi, Nagore - 611 002.  
Nagapattinam (Dt) Tamil Nadu.**

E.G.S.PILLAY ENGINEERING COLLEGE,[AUTONOMOUS]NAGAPATTINAM – 611002

Approved by AICTE,New Delhi | Affiliated to Anna University,Chennai

Accredited by NAAC with 'A' Grade | An ISO 9001:2015 Certified Institution

Nagapattinam – 611001 Tamil Nadu India

Ph:04365 -251112 / 251114 | E-mail:enquiries@egspec.org | Website : [WWW.egspec.org](http://WWW.egspec.org)

## Two Days Faculty Development Program

On

## Web Application Development

Using J2EE

1<sup>st</sup> & 2<sup>nd</sup> June 2019

### AGENDA

| DATE                  | TIME                  | PROGRAM               |
|-----------------------|-----------------------|-----------------------|
| 01.06.2019            | 09.30 A.M – 10.00 A.M | Inauguration Function |
|                       | 10.00 A.M – 11.30 A.M | Session               |
|                       | 11.30 A.M – 11.45 A.M | Break                 |
|                       | 11.45 A.M – 01.00 P.M | Session               |
|                       | 01.00 P.M – 01.30 P.M | Break                 |
|                       | 01.30 P.M – 03.00 P.M | Session               |
|                       | 03.00 P.M – 03.15 P.M | Break                 |
|                       | 03.15 P.M – 04.30 P.M | Session               |
| 02.06.2019            | 09.30 A.M – 10.00 A.M | Inauguration          |
|                       | 10.00 A.M – 11.30 A.M | Session               |
|                       | 11.30 A.M – 11.45 A.M | Break                 |
|                       | 11.45 A.M – 01.00 P.M | Session               |
|                       | 01.00 P.M – 01.30 P.M | Break                 |
|                       | 01.30 P.M – 03.00 P.M | Session               |
|                       | 03.00 P.M – 03.15 P.M | Break                 |
|                       | 03.15 P.M – 04.30 P.M | Session               |
| 04.30 P.M – 05.00 P.M | Valedictory           |                       |

### VENUE

|              |   |                                |
|--------------|---|--------------------------------|
| Inauguration | - | PG Conference Hall             |
| Session      | - | Common Computing Lab (PGB 104) |
| Valedictory  | - | PG Conference Hall             |

ATTESTED  
  
Dr. S. RAMABALAN, M.E., Ph.D.,  
PRINCIPAL  
E.G.S. Pillay Engineering College,  
Thethi, Nagore - 611 002.  
Nagapattinam (Dt) Tamil Nadu.

Nagapattinam

29.05.2019

From

Mrs.A.Hema

Assistant Professor/ MCA,

E.G.S.Pillay Engineering College,

Nagapattinam.

To

The Principal,

E.G.S.Pillay Engineering College,

Nagapattinam.

Thru,

Mrs.J.Vanitha,

Professor/ HOD/MCA,

E.G.S.Pillay Engineering College,

Nagapattinam

Respected Sir,

Sub: Permission to organize Two Days Faculty Development Program – Reg.

Our Department is to plan to organize the Faculty Development Program on "Web Application Development Using J2EE. So, I kindly request you to give permission for organizing the Program on 1<sup>st</sup> & 2<sup>nd</sup> June 2019.

Thanking you,

Yours truly,

[Mrs.A.Hema]

*[Handwritten Signature]*  
29.5.19  
MCA

**ATTESTED**  
*[Handwritten Signature]*  
**Dr. S. RAMABALAN, M.E., Ph.D.,**  
**PRINCIPAL**  
E.G.S. Pillay Engineering College,  
Thethi, Nagore - 611 002.  
Nagapattinam (Dt) Tamil Nadu.



**E.G.S.PILLAY ENGINEERING COLLEGE,[AUTONOMOUS]NAGAPATTINAM – 611002**  
Approved by AICTE,New Delhi |Affiliated to Anna University,Chennai  
Accredited by NAAC with 'A' Grade | An ISO 9001:2015 Certified Institution  
Nagapattinam – 611001 Tamil Nadu India  
Ph:04365 -251112 / 251114 | E-mail:enquiries@egspec.org | Website : [WWW.egspec.org](http://WWW.egspec.org)

**DEPARTMENT OF MCA**

**Circular Dated 25-05-2019**

We are happy to inform that our MCA department is going to organize a Two days faculty Development Program “on Web Application Development Using J2EE “on 01.06.2019 and 02.06.2019 at PG Conference Hall in PG block.

The Sessions are handled by, Mrs.A.Suganthi, Assistant Professor from A.V.C.E.C, Mayiladuthurai, Mrs.A.Hema,AP/MCA and Ms.N.lakkiya,AP/MCA. All the HODs and Staff members are invited.

  
HOD/MCA

  
PRINCIPAL

Copy To: The Secretary, The Principal, The Vice Principal, HODs, T&P, R&D, Transport, Library and File.

**ATTESTED**

  
**Dr. S. RAMABALAN, M.E., Ph.D.,**  
**PRINCIPAL**  
E.G.S. Pillay Engineering College,  
Thethi, Nagore - 611 002.  
Nagapattinam (Dt) Tamil Nadu.

E.G.S.PILLAY ENGINEERING COLLEGE,[AUTONOMOUS]NAGAPATTINAM – 611002

Approved by AICTE,New Delhi | Affiliated to Anna University,Chennai

Accredited by NAAC with 'A' Grade | An ISO 9001:2015 Certified Institution

Nagapattinam – 611001 Tamil Nadu India

Ph:04365 -251112 / 251114 | E-mail:enquiries@egspec.org | Website : [WWW.egspec.org](http://WWW.egspec.org)

**Two Days Faculty Development Program  
On  
Web Application Development  
Using J2EE  
1<sup>st</sup> & 2<sup>nd</sup> June 2019**

**SESSION DETAILS**

| <b>Date/<br/>Session</b> | <b>I Session<br/>10.00 a.m.<br/>to 11.30 a.m</b>   |              | <b>II Session<br/>11.45 a.m.<br/>to 01.00<br/>p.m</b>                     |              | <b>III Session<br/>01.30 p.m. to<br/>03.00 p.m.</b>   |              | <b>IV Session<br/>03.15 p.m.<br/>to 04.30<br/>p.m.</b>  |
|--------------------------|--|--------------|---|--------------|---|--------------|---|
| <b>01.06.2019</b>        | <b>Module 1:</b><br>Introduction<br>to Web<br>Application<br>Developmen<br>t   | <b>Break</b> | <b>Module 2:</b><br>J2EE<br>Architecture<br>and their<br>Components       | <b>Break</b> | <b>Module 3:</b><br>Develop Web<br>Application<br>with J2EE<br>Components   | <b>Break</b> | <b>Module 4:</b><br>MVC<br>Framework<br>for creating<br>modern java<br>web<br>Application                       |
| <b>02.06.2019</b>        | <b>Module 5:</b><br>Understandi<br>ng Struts<br>framework<br>and struts<br>flow for<br>creating<br>dynamic<br>web project. |              | <b>Module 6:</b><br>Struts flow<br>with an<br>example<br>Application<br>s |              | <b>Module 7:</b><br>Understandin<br>g LDAP<br>Concepts and<br>Develop any<br>web<br>application<br>which<br>authenticates<br>using LDAP |              | <b>Module 8:</b><br>Develop<br>java<br>application<br>or a web<br>application<br>by using<br>LDAP<br>attributes |

**ATTESTED**

  
**Dr. S. RAMABALAN, M.E., Ph.D.,  
PRINCIPAL**

**E.G.S. Pillay Engineering College,  
Thethi, Nagore - 611 002.  
Nagapattinam (Dt) Tamil Nadu.**

E.G.S.PILLAY ENGINEERING COLLEGE,[AUTONOMOUS]NAGAPATTINAM – 611002

Approved by AICTE,New Delhi |Affiliated to Anna University,Chennai

Accredited by NAAC with 'A' Grade | An ISO 9001:2015 Certified Institution

Nagapattinam – 611001 Tamil Nadu India

Ph:04365 -251112 / 251114 | E-mail:enquiries@egspec.org | Website : [WWW.egspec.org](http://WWW.egspec.org)

**Two Days Faculty Development Program  
On  
Web Application Development  
Using J2EE  
1<sup>st</sup> & 2<sup>nd</sup> June 2019  
RESOURCE PERSON PROFILE**

|   |   |          |                |          |      |
|---|---|----------|----------------|----------|------|
| Name: Mrs.A.SUGANTHI                                    |   |          |                |          |      |
| Designation   | Assistant Professor<br>Department of MCA<br>A.V.C.College of Engineering,<br>Mannampandal,<br>Mayilladuthruai 609 305 |          |                |          |      |
| Qualification   | M.C.A. M.Phil.,(Ph.D.)  |          |                |          |      |
| Experience  | Total : 13 Years 1 Month  |          |                |          |      |
|   | Academic : 13 Years 1 Month   |          | Industry : Nil |          |      |
| Publications  | Conference  |          | Journal        |          | Book |
|   | Inter National  | National | Inter National | National |      |
|   | 2   | 8        | 1              | Nil      | Nil  |
| FDTP/Workshop/ Seminar Attended                         | 26  |          |                |          |      |
| FDTP/Workshop/Seminar Organized                         | Nil   |          |                |          |      |
| No. of Research Scholars guided                         | Nil   |          |                |          |      |
| Professional Affiliations                               | ISTE - Life Member  |          |                |          |      |
| Details of fund received from various external agencies | Nil   |          |                |          |      |
| Awards received   | Awards received for 100% result in Anna University examination.   |          |                |          |      |
| Other information's                                     | <b>Qualified</b><br>UGC - NET Examination in Computer Science & Applications in July 2015.                            |          |                |          |      |

**Dr. S. RAMABALAN, M.E., Ph.D.,**

**PRINCIPAL**

**E.G.S. Pillay Engineering College,**

**Thethi, Nagore - 611 002.**

**Nagapattinam (Dt) Tamil Nadu.**

**E.G.S.PILLAY ENGINEERING COLLEGE,[AUTONOMOUS]NAGAPATTINAM – 611002**  
**Approved by AICTE,New Delhi | Affiliated to Anna University,Chennai**  
**Accredited by NAAC with 'A' Grade | An ISO 9001:2015 Certified Institution**  
**Nagapattinam – 611001 Tamil Nadu India**  
**Ph:04365 -251112 / 251114 | E-mail:enquiries@egspec.org | Website : [WWW.egspec.org](http://WWW.egspec.org)**

**Two Days Faculty Development Program**  
**On**  
**Web Application Development**  
**Using J2EE**  
**1<sup>st</sup> & 2<sup>nd</sup> June 2019**  
**Participants List**

| S. No. | Name Of Participant                    | Affiliated Department and Institute (with full address)                                 | Email Id                       | Contact No  |
|--------|--|---|--------------------------------|-------------|
| 1      | Mr.Manivannan,<br>Assistant Professor, | E.G.S.Pillay Arts & Science College<br>Nagapattinam.                                    | manibcommca@gmail.com          | 8220331731  |
| 2      | HAMAMALINI<br>ASSISTANT PROFESSOR      | AVC Arts and Science college  | maliniavcce2007@rediffmail.com | 9442389661  |
| 3      | Mrs. S.VISALATCHY                      | E.g.s.Pillay Engineering College<br>Department of MCA                                   | visalatchy@egspec.org          | 9698008348  |
| 4      | Mr.T.MOHAMED AMEER ILYAS,              | IMRB<br>Executive Analysis Operation,<br>No 63,Pantheon Road,<br>Kantar IMRB,<br>Egmore | E-Mail:ameerilyas75@gmail.com, | 8754842505. |
| 5      | V.PRABA<br>ASSISTANT PROFESSOR         | E.G.S.Pillay Polytechnic College<br>Nagapattinam  | Prabu5693@gmail.com            | 7305010875  |
| 6      | MR.P.ARUNKUMAR<br>ASSISTANT PROFESSOR  | Pondicherry University,<br>Karaikal Campus.   | arunkumar.pselvam@gmail.com    | 9003131147  |
| 7      | BALAJI<br>System Analyst               | HCL Technologies<br>No. 84, Greams Road,<br>Thousand Lights, Chennai,                   | Balaji_mo8@infosys.com         | 9787351733  |
| 8      | S.RAMANAN<br>Software Maintance        | AVS Infotech Software System Chennai  | ramananjava@gmail.com          | 8124538295  |
| 9      | DIVYA BHARATHI S<br>Software Designer  | IMRB<br>No 63,Pantheon Road,<br>Kantar IMRB,<br>Egmore                                  | bharathid528@gmail.com         | 9003985187  |
| 10     | P.NALINI<br>Software Tester            | Vinayak Infotech,Chennai  | Nalininlini05@gmail.com        | 9524198279  |
| 11     | GAYATHRI.R<br>ASSISTANT PROFESSOR      | Department of CS E.G.S.Pillay Arts and Science College,<br>Nagapattinam                 | gayathriamr@egspec.org         | 9693284798  |

**ATTESTED**

**Dr. S. RAMABALAN, M.E., Ph.D.,**

**PRINCIPAL**

**Thethi, Nagore - 611 002.**  
**Nagapattinam (Dt) Tamil Nadu.**



|    |                                      |  |  |            |
|----|--------------------------------------|--|--|------------|
| 12 | GAYATHRI.T<br>ASSISTANT PROFESSOR    | Department of CS E.G.S.Pillay<br>Arts and Science College,<br>Nagapattinam | <a href="mailto:gayathrit146@gmail.com">gayathrit146@gmail.com</a>             | 9894134045 |
| 13 | JAYALAKSHMI.C<br>ASSISTANT PROFESSOR | Department of CS E.G.S.Pillay<br>Arts and Science College,<br>Nagapattinam | <a href="mailto:jayalavanya94@gmail.com">jayalavanya94@gmail.com</a>           | 8526089406 |
| 14 | KEERTHIKA.A<br>ASSISTANT PROFESSOR   | Department of CSE,SINCET,<br>Nagapattinam                                  | <a href="mailto:keerthibaby95@gmail.com">keerthibaby95@gmail.com</a>           | 8940721616 |
| 15 | KIRUTHIKA.K<br>ASSISTANT PROFESSOR   | Department of CSE,SINCET,<br>Nagapattinam                                  | <a href="mailto:keerthikannanmca26@gmail.com">keerthikannanmca26@gmail.com</a> | 9788646778 |

**ATTESTED**



**Dr. S. RAMABALAN, M.E., Ph.D.,  
PRINCIPAL**

**E.G.S. Pillay Engineering College,  
Thethi, Nagore - 611 002.  
Nagapattinam (Dt) Tamil Nadu.**

**E.G.S.PILLAY ENGINEERING COLLEGE,[AUTONOMOUS]NAGAPATTINAM – 611002**

**Approved by AICTE,New Delhi | Affiliated to Anna University,Chennai**

**Accredited by NAAC with 'A' Grade | An ISO 9001:2015 Certified Institution**

**Nagapattinam – 611001 Tamil Nadu India**

**Ph:04365 -251112 / 251114 | E-mail:enquiries@egspec.org | Website : [WWW.egspec.org](http://WWW.egspec.org)**

**Two Days Faculty Development Program  
On  
Web Application Development  
Using J2EE**

**1<sup>st</sup> & 2<sup>nd</sup> June 2019**

**Report**

The Two Days FDP on Web Application Development Using J2EE was organized by Department of Computer Applications, E.G.S.Pillay Engineering College, Nagapattinam. 1<sup>st</sup> and 2<sup>nd</sup> June 201.

On the day, the inaugural function was started by lighting kuthuvillaku by our honorable HOD Mrs.J.Vanitha,Asso.Prof. The inaugural address was given by Mrs.A.Hema,AP/MCA brief note about the course and importance of it. The inaugural session was ended by vote of thanks.

The 1<sup>st</sup> day start at 4th May 2017 10.00 AM. In Morning Session were discussed the Course Objectives, Course outcome and Journey to this Platform and also discussed about the Introduction to Web Application Development, J2EE Architecture and their Components and the remaining half day which covered the topics of Develop Web Application with J2EE Components and MVC Framework for creating modern java web Application.

The 2nd day start at 5th May 2017 10.00 AM. In Morning Session were discussed about the topic of Understanding Struts framework and struts flow for creating dynamic web project and Struts flow with an example Applications and In Afternoon Session which covered the topics of Understanding LDAP Concepts and Develop any web application which authenticates using LDAP Develop java application or a web application by using LDAP attributes, After this sessions Valedictory function was Organized.

The Coordinators arranged the program in good manner. Vote of thanks was given by Ms.N.Ilakkiya,AP/MCA coordinator of the FDP.

We thanks to respected our honorable secretary Shri.S.Parameswaran, respected principal Dr.S.Ramabalan, Vice principal Dr.V.Mohan and Our Head of the department Asso.Prof J.Vanitha for their valuable support and encouragement to successful conduction of such a excellent FDP. We also thank to the staff members of both the department and student volunteers for their motivational support.

**ATTESTED**



**Dr. S. RAMABALAN, M.E., Ph.D.,  
PRINCIPAL**

**E.G.S. Pillay Engineering College,  
Thethi, Nagore - 611 002.  
Nagapattinam (Dt) Tamil Nadu.**

E.G.S.PILLAY ENGINEERING COLLEGE,[AUTONOMOUS]NAGAPATTINAM – 611002

Approved by AICTE,New Delhi |Affiliated to Anna University,Chennai

Accredited by NAAC with 'A' Grade | An ISO 9001:2015 Certified Institution

Nagapattinam – 611001 Tamil Nadu India

Ph:04365 -251112 / 251114 | E-mail:enquiries@egspec.org | Website : [WWW.egspec.org](http://WWW.egspec.org)

## Two Days Faculty Development Program

On

### Web Application Development

### Using J2EE

1<sup>st</sup> & 2<sup>nd</sup> June 2019

FEED BACK FORM

Name of the Participant: M.S.A. KEERTHIKA

Date: 01.06.2019 TO 02.06.2019

Organization: SINCEET

For the following areas, please indicate your rating:

| A. Content   | 1<br>Average                             | 2<br>Good | 3<br>Excellent |
|--|--|-----------|----------------|
| <b>1.FDP Format</b>  |  |           | ✓              |
| 1.1 The overall flow of the FDP was well structured to meet the learning outcomes and to produce the required outputs.                               |  |           | ✓              |
| 1.2 The room and break out facilities were adequate to meet the requirements of the FDP.   |  | ✓         |                |
| 1.3 Two days was the correct amount of time to cover the subject matter of the FDP.  |  |           | ✓              |
| <b>2.FDP Content</b>   |  |           |                |
| 2.1 The executive was adequately briefed in advance of the FDP.  |  | ✓         |                |
| 2.2 Purpose of the FDP (why it is being carried out) was clear.  |  |           | ✓              |
| 2.3 The objectives/ expected outputs of the FDP were clear.  |  | ✓         |                |
| 2.4 The objectives/ expected outputs of the FDP were achieved.   |  |           | ✓              |
| 2.5 The individual exercises/ case studies were relevant to achieving the objectives/ expected outcomes of the work.                                 |  | ✓         |                |
| <b>3.FDP Materials</b>   |  |           |                |
| 3.1 The reference manual provided valuable information to support the FDP.   |  |           | ✓              |
| 3.2 The course folder (Slides and notes folder) was useful to record the content of the FDP – Presenter's material and contributions from the group. |  |           | ✓              |
| B. How could this FDP be improved?   |  |           |                |
| C. Any other comments or suggestions?  |  |           |                |
| D. Overall, how would you rate this FDP?   | [ ] POOR [ ] FAIR [ ] GOOD [ ] EXCELLENT |           |                |

ATTESTED

  
**Dr. S. RAMABALAN, M.E., Ph.D.,**  
**PRINCIPAL**  
E.G.S. Pillay Engineering College,  
Thethi, Nagore - 611 002.  
Nagapattinam (Dt) Tamil Nadu.

  
Participant Signature

**E.G.S.PILLAY ENGINEERING COLLEGE,[AUTONOMOUS]NAGAPATTINAM – 611002**

**Approved by AICTE,New Delhi | Affiliated to Anna University,Chennai**

**Accredited by NAAC with 'A' Grade | An ISO 9001:2015 Certified Institution**

**Nagapattinam – 611001 Tamil Nadu India**

**Ph:04365 -251112 / 251114 | E-mail:enquiries@egspec.org | Website : [WWW.egspec.org](http://WWW.egspec.org)**

**Two Days Faculty Development Program**

**On**

**Web Application Development**

**Using J2EE**

**1<sup>st</sup> & 2<sup>nd</sup> June 2019**

Sample Photos



**ATTESTED**

**Dr. S. RAMABALAN, M.E., Ph.D.,  
PRINCIPAL**

**E.G.S. Pillay Engineering College,  
Thethi, Nagore - 611 002.  
Nagapattinam (Dt) Tamil Nadu.**



**E.G.S.PILLAY ENGINEERING COLLEGE,[AUTONOMOUS]NAGAPATTINAM – 611002**

Approved by AICTE,New Delhi | Affiliated to Anna University,Chennai

Accredited by NAAC with 'A' Grade | An ISO 9001:2015 Certified Institution

Nagapattinam – 611001 Tamil Nadu India

Ph:04365 -251112 / 251114 | E-mail:enquiries@egspec.org | Website : [WWW.egspec.org](http://WWW.egspec.org)

**Two Days Faculty Development Program  
On**

**Web Application Development**

**Using J2EE**

**1<sup>st</sup> & 2<sup>nd</sup> June 2019**

Sample Photos



**ATTESTED**

  
**Dr. S. RAMABALAN, M.E., Ph.D.,  
PRINCIPAL**

**E.G.S. Pillay Engineering College,  
Thethi, Nagore - 611 002.  
Nagapattinam (Dt) Tamil Nadu.**

**Two Days Faculty Development Program**  
**On**  
**Web Application Development**  
**Using J2EE**  
*1<sup>st</sup> & 2<sup>nd</sup> June 2019*  
**SAMPLE PROGRAMS**

**DEVELOP A WEB APPLICATION WITH TWO-TIER ARCHITECTURE**

**AIM:**

To develop a car showroom inventory web application with two tier architecture using jsp and jdbc.

**PROCEDURE:**

**STEP1:** Click Wamp server choose mysql then go to console Mysql.

**STEP2:** Create database and table using

Create database test;

Use test;

Create table users(values);

**STEP3:** Open NetBeans->File->New Project->Javaweb->Project Name->Glass Fish 4.0->Finish.

**STEP4:** In index.html, write the html coding.

**STEP5:** Right click the project name and select jsp.

**STEP6:** Write the project name and add jar file to the project.

**STEP7:** Right click the project name and add jar file to the project.

**STEP8:** Execute the project.

**STEP9:** Open console Mysql on Wamp server and display the table.

**STEP10:** Stop the Program.

**ATTESTED**  
  
**Dr. S. RAMABALAN, M.E., Ph.D.,**  
**PRINCIPAL**  
E.G.S. Pillay Engineering College,  
Thethi, Nagore - 611 002.  
Nagapattinam (Dt) Tamil Nadu.

# DEVELOP A WEB APPLICATION WITH 2- TIER ARCHITECTURE

```
c:\wamp\bin\mysql\mysql5.6.17\bin\mysql.exe
Enter password:
Welcome to the MySQL monitor.  Commands end with ; or \g.
Your MySQL connection id is 2
Server version: 5.6.17 MySQL Community Server (GPL)

Copyright (c) 2000, 2014, Oracle and/or its affiliates. All rights reserved.
Oracle is a registered trademark of Oracle Corporation and/or its
affiliates. Other names may be trademarks of their respective
owners.

Type 'help;' or '\h;' for help. Type '\q;' to clear the current input statement.

mysql> create database cart;
Query OK, 1 row affected (0.03 sec)

mysql> use cart;
Database changed
mysql> create table users (email varchar(100), first_name varchar(100), last_name varchar(100), username varchar(100), password varchar(100));
Query OK, 0 rows affected (0.05 sec)

mysql> desc users;
+-----+-----+-----+-----+-----+-----+
| Field | Type | Null | Key | Default | Extra |
+-----+-----+-----+-----+-----+-----+
| email | varchar(100) | YES | | NULL | |
| first_name | varchar(100) | YES | | NULL | |
| last_name | varchar(100) | YES | | NULL | |
| username | varchar(100) | YES | | NULL | |
| password | varchar(100) | YES | | NULL | |
+-----+-----+-----+-----+-----+-----+
5 rows in set (0.05 sec)

mysql> _
```

## DESIGN WINDOW

Email:

First name:

Last name:

User name:

password:

## SOURCE CODE

### Index.jsp

```
<%@ page import = "java.sql.*" %>
<%@ page import = "javax.sql.*" %>
<%@page contentType="text/html" pageEncoding="UTF-8"%>
```

**ATTESTED**  
  
**Dr. S. RAMABALAN, M.E., Ph.D.,**  
**PRINCIPAL**  
**E.G.S. Pillay Engineering College,**  
**Thethi, Nagore - 611 002.**  
**Nagapattinam (Dt) Tamil Nadu.**

```
<!DOCTYPE html>

<html>

<head>

<meta http-equiv="Content-Type" content="text/html; charset=UTF-8">

</head>

<body>

<%

String user=request.getParameter("userid");

session.putValue("userid",user);

String pwd=request.getParameter("pwd");

String fname=request.getParameter("fname");

String lname=request.getParameter("lname");

String email=request.getParameter("email");

Class.forName("com.mysql.jdbc.Driver");

java.sql.Connection con = DriverManager.getConnection("jdbc:mysql://localhost:3306/car","root","");

Statement st= con.createStatement();

ResultSet rs;

int i=st.executeUpdate("insert into user values ('"+user+"','"+pwd+"','"+fname+"','"+lname+"','"+email+"')");

%> </body>

</html>
```

**ATTESTED**  
  
**Dr. S. RAMABALAN, M.E., Ph.D.,**  
**PRINCIPAL**  
**E.G.S. Pillay Engineering College,**  
**Thethi, Nagore - 611 002.**  
**Nagapattinam (Dt) Tamil Nadu.**



**OUTPUT:**

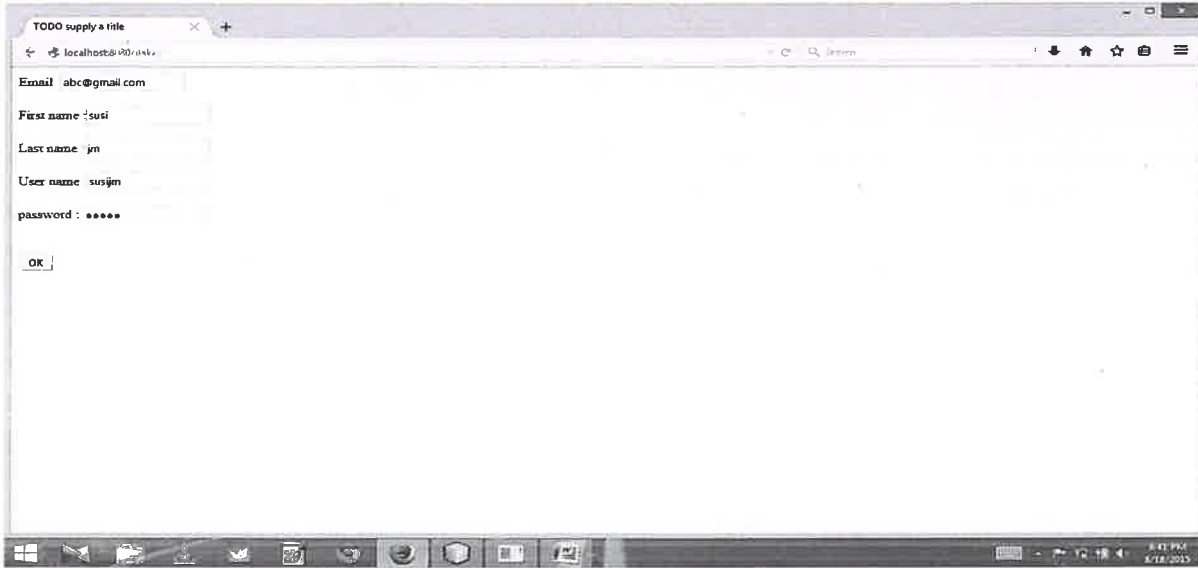

**ATTESTED**

**Dr. S. RAMABALAN, M.E., Ph.D.,  
PRINCIPAL  
E.G.S. Pillay Engineering College,  
Thethi, Nagore - 611 002.  
Nagapattinam (Dt) Tamil Nadu.**

**E.G.S.PILLAY ENGINEERING COLLEGE,[AUTONOMOUS]NAGAPATTINAM – 611002**

**Approved by AICTE,New Delhi | Affiliated to Anna University,Chennai**

**Accredited by NAAC with 'A' Grade | An ISO 9001:2015 Certified Institution**

**Nagapattinam – 611001 Tamil Nadu India**

**Ph:04365 -251112 / 251114 | E-mail:enquiries@egspec.org | Website : [WWW.egspec.org](http://WWW.egspec.org)**

**Two Days Faculty Development Program**





**On**

**Web Application Development**

**Using J2EE**

**1<sup>st</sup> & 2<sup>nd</sup> June 2019**

**Sample Certificate**

|   |  |  |
|---|--|--|
|   | <p><b>E.G.S. Pillay Engineering College, Nagapattinam – 611002</b><br/>Approved by AICTE, New Delhi   Affiliated to Anna University, Chennai<br/>Accredited by NAAC with 'A' Grade   An ISO 9001:2015 Certified Institution<br/>Nagapattinam – 611002 Tamil Nadu India</p> |  |
| <p><b>Two Days Faculty Development Program On Web Application Development<br/>Using J2EE 1<sup>st</sup> &amp; 2<sup>nd</sup> June 2019</b></p>  |  |  |
| <p><b>CERTIFICATE OF PARTICIPANTS</b></p> <p>This is to certify that</p> <p><i>M.S. GAYATHRI R. AP.</i> DEPARTMENT OF CS<br/>of<br/>E.G.S. Pillay Arts &amp; Science<br/>Has attended<br/>FDP ON WEB APPLICATION DEVELOPMENT USING J2EE</p> <p> Coordinator</p> <p> Convener</p> |  |  |

**ATTESTED**

**Dr. S. RAMABALAN, M.E., Ph.D.,**

**PRINCIPAL**

**E.G.S. Pillay Engineering College,**

**Thethi, Nagore - 611 002.**

**Nagapattinam (Dt) Tamil Nadu.**



## CENTRE FOR FACULTY DEVELOPMENT

Anna University, Chennai-600 025

Phone : 044 - 22358217, Fax : 044 - 22301692

E-mail : annauniversitycfd@gmail.com

Dr.D.Sridharan  
Director

Dr. Arul Aram  
Additional Director

Letter No.27/CFD/Winter/ FDTP/Self Finance/2018-29 ✓

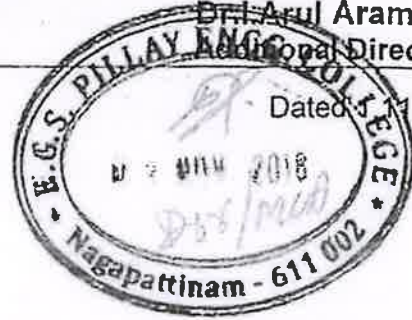

To  
The Principal  
E.G.S Pillay Engineering College  
Nagapattinam - 611 002.

Sir/Madam

Sub: Centre for Faculty Development – Two-Week Conduct of Faculty Development Training Programme for Winter Vacation 2018 – Intimation – Reg.

\*\*\*\*\*

I am happy to inform you that your proposal has been selected for conducting the Faculty Development Training Programme (FDTP) for your Department / Institution during **Nov / Dec 2018** without any financial support.

In this regard, Principal and Co-ordinators are requested to conduct the programme without collecting any fees from participants and also advised to go through the enclosed Guidelines for conducting FDTP. I request you to kindly acknowledge the receipt of this letter with signed copy of the Guidelines for conducting Two-Week Faculty Development Training Programme.

| Branch     | Semester | Code No. | Name of the Programme | Name and Designation of the Co-ordinator(s)                       |
|------------|----------|----------|-----------------------|---|
| B.E<br>CSE | VI       | CS 6601  | Distributed Systems   | 1. Dr. A. S. Anakath, Prof.,<br>2. Mr.M. Rajakumaran, Asst. Prof. |

Further, I would like to inform you that officials will make surprise inspection during the programme.

Sincerely yours,

  
Director, CFD

**NOTE:** Brochure, Attendance, Feedback & Declaration form can be downloaded from the website [cfd.annauniv.edu](http://cfd.annauniv.edu) under the link "Downloads"

ATTESTED

  
Dr. S. RAMABALAN, M.E., Ph.D.,  
PRINCIPAL

E.G.S. Pillay Engineering College,  
Thethi, Nagore - 611 002,  
Nagapattinam (Dt) Tamil Nadu.

**E.G.S. PILLAY ENGINEERING COLLEGE (AUTONOMOUS), NAGAPATTINAM**

**DEPARTMENT OF CSE**

**ANNA UNIVERSITY SPONSORED TWO WEEKS FACULTY DEVELOPMENT  
PROGRAM ON CS6601 DISTRIBUTED SYSTEMS – 15-12-2018 to 28-12-2018**

**CONTENTS**

1. Approval Letter
2. Synopsis of the programme
3. Guidelines of the programme
4. Programme Schedule
5. Resource Person details
6. Registration form
7. Participants Attendance
8. Declaration form
9. Feedback form
10. Sample Photos
11. Analysis Report

**ATTESTED**

  
**Dr. S. RAMABALAN, M.E., Ph.D.,  
PRINCIPAL  
E.G.S. Pillay Engineering College,  
Thethi, Nagore - 611 002.  
Nagapattinam (Dt) Tamil Nadu.**



**E.G.S. PILLAY ENGINEERING COLLEGE**  
(An Autonomous Institution, Affiliated to Anna University, Chennai)  
Nagore Post, Nagapattinam – 611 002, Tamilnadu.



**DEPARTMENT OF COMPUTER SCIENCE AND ENGINEERING**  
**DEPARTMENT OF MASTER OF COMPUTER APPLICATIONS**  
**TWO WEEKS FDTP**

**ON**  
**CS6601- Distributed Systems**  
**15-12-2018 to 28-12-2018**  
(Approved by CFD Anna University)

**A Report**

A two weeks Faculty Development Programme on CS6601- Distributed Systems was organized jointly by the Department of Computer Applications and Department of Computer Science and Engineering of our college from 15<sup>th</sup> December to 28<sup>th</sup> December 2018. The aim of the FDTP was to provide the faculty members an opportunity to develop their knowledge in the field of Distributed Systems and Computing, which is a remarkable and important field of Computer Science and Information Technology. In fact, today's Internet of World Wide Web uses distributed systems for its functioning. Most popular social sites such as Facebook, Twitter, Instagram, etc., are the distributed systems. There were 18 External candidates and 7 Internal candidates participated in the FDTP out of which 5 are from *University College of Engineering*, a constituent college of *Anna University Chennai*.



Despite of the *disasters of Gaja cyclone*, we have conducted the FDTP, but with a deviation from the actual schedule which was rescheduled between 15-12-2018 and 28-12-2018. The FDTP started with a brief inauguration function on 15-12-2018 followed by the first session of the FDTP by Dr. M. Chinnadurai, Dean of our institution. All the sessions were conducted with experts from other institutions and also from our college. There were 8 *external experts* and 8 *internal experts* from Anna University and other Universities and institutes handled the sessions effectively.

The sessions were engaged with more effective teaching methods. At the end of each session, creative and research oriented information were discussed with the participants by the subject experts. Case studies are conducted with Practical sessions, to enhance their knowledge on distributed systems. These would really also be useful to the teachers who are pursuing research programme in part time mode.

The two weeks programme had come to an end on 28-12-2018. Prof. R. Kannadasan, from VIT University presented the last session and feedback on the entire programme was collected from all the participants. The FDTP concluded with a small valedictory function, in which Prof. R. Kannadasan of VIT University addressed to the participants. The participants were given the assurance that the FDTP participation certificates will be sent by post as soon as the certificates are received from CFD.

The FDTP was coordinated by Dr. A. S. Anakath, Professor of Computer Applications and Prof. M. Rajakumaran, Assistant Professor of CSE of our College.

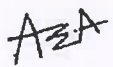
**Name & Signature of Coordinators**

1. Dr. A. S. Anakath 
2. Prof. M. Rajakumaran 

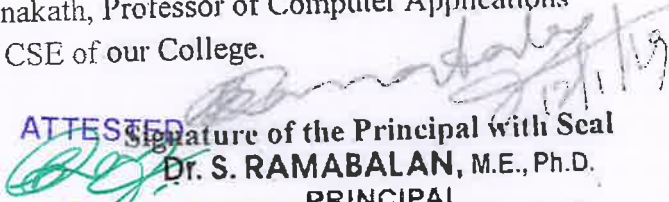
**ATTESTED**  
  
**Signature of the Principal with Seal**  
**Dr. S. RAMABALAN, M.E., Ph.D.**  
**PRINCIPAL**  
**E.G.S. PILLAY ENGINEERING COLLEGE**  
**NAGAPATTINAM - 611 002**  
E.G.S. Pillay Engineering College,  
Thethi, Nagore - 611 002  
Nagapattinam (Dt) Tamil.



CENTRE FOR FACULTY DEVELOPMENT  
ANNA UNIVERSITY, CHENNAI-25

TWO-WEEK FACULTY DEVELOPMENT TRAINING PROGRAMME (WINTER VACATION 2018)  
(Self Financing Engineering Colleges)

GUIDELINES

- 1) No participation fee should be collected.
- 2) Faculty Development Training programme should be conducted for the duration of **Two weeks (minimum of 12 days)**.
- 3) Faculty from Affiliated Engineering Colleges only are eligible for this FDTP and **not from any other University and other State University**.
- 4) Total number of participants is **strictly** restricted to 25 with a minimum of 20 external participants. Certificates will be issued only for the first 25 No. of participants. **No request on this will be considered**
- 5) Following factors may be considered while selecting the participants.
  - a. Participants will be selected on first come & first served basis.
  - b. Priority should be given to Asst. & Associate Professor.
- 6) Accommodation shall be provided to the participants from outstation at **free of cost subject to availability**.
- 7) The time schedule for the programme is given below.

|             |   |            |    |            |
|-------------|---|------------|----|------------|
| I Session   | - | 9.00 a.m.  | to | 10.30 a.m. |
| II Session  | - | 10.45 a.m. | to | 12.15 p.m. |
| III Session | - | 1.30 p.m.  | to | 3.00 p.m.  |
| IV Session  | - | 3.15 p.m.  | to | 4.45 p.m.  |

- 8) The certificate of participation will be provided only after completion of the programme and submission of following documents to the Centre for Faculty Development, Anna University, Chennai-25.

|        |   |  |
|--------|---|--|
| (I)    | <b>One page report of the programme</b>           |  |
| (II)   | <b>List of faculty Experts and topics covered</b> |  |
| (III)  | <b>Programme CD's</b>                             |  |
| (IV)   | <b>Programme schedule</b>                         |  |
| (V)    | <b>Participants attendance sheet</b>              | } download the format from the website <a href="http://cid.annauniv.edu">cid.annauniv.edu</a> under the link "Downloads" |
| (VI)   | <b>Participants feedback form</b>                 |  |
| (VII)  | <b>Participants declaration form</b>              |  |
| (VIII) | <b>Brochure form</b>                              |  |

- 9) The Coordinator may be requested to prepare the brochure **as per the downloaded format** and send the brochure to all the affiliated engineering colleges. A copy should also be sent to the Centre for Faculty Development, Anna University, Chennai-25.
- 10) Officials will make surprise inspection during the programme.

**Name & Signature of Coordinators**

1 Dr. A.S. ANAKATH *ASAT*

2 M. RAJAKUMARAO, *m.raj*

**ATTESTED**  
*[Signature]*  
Dr. S. RAJAKUMARAO, M.E., Ph.D.  
PRINCIPAL  
E.G.S. Pillay Engineering College  
Thethi, NAGAPATTINAM (DT)  
NAGAPATTINAM - 611 002

## Program Schedule

**Subject Name :** Distributed Systems  
**Code No :** CS6601  
**Branch :** Computer Science and Engineering  
**Semester :** VI  
**Duration :** 15/12/2018 – 28/12/2018 (14 days)

### Week One

| Date       | Session I<br>09-00 – 10.30   | Session II<br>10.45 – 12.15 p.m.  | Session III<br>01.30 p.m. – 03.00 p.m.                      | Session IV<br>03.15 p.m. – 04.45p.m.                         |
|------------|--|---|---|--|
| 15-12-2018 | Introduction to Distributed System<br><b>Dr. M. Chinnadurai</b>              | Examples of Distributed Systems<br><b>Dr. M. Chinnadurai</b>              | Trends in Distributed Systems<br><b>Dr. T. Ganesan</b>      | Trends in Distributed Systems<br><b>Dr. T. Ganesan</b>       |
| 16-12-2018 | Focus on resource sharing<br><b>Dr. M. Aramudhan</b>                         | Challenges of Distributed Systems<br><b>Dr. M. Aramudhan</b>              | Case study: WWW<br><b>Prof. J. Vanitha</b>                  | Case study: WWW<br><b>Prof. J. Vanitha</b>                   |
| 17-12-2018 | Inter process Communication<br><b>Dr. M. Azees</b>                           | Multicast communication<br><b>Dr. M. Azees</b>                            | Network virtualization<br><b>Dr. M. Azees</b>               | Case study: MPI<br><b>Dr. M. Azees</b>                       |
| 18-12-2018 | Request-reply protocols<br><b>Dr. S. Kannan</b>                              | Remote procedure call<br>Remote method invocation<br><b>Dr. S. Kannan</b> | Case study: Java RMI<br><b>Dr. M. Chinnadurai</b>           | Case study: Java RMI<br><b>Dr. M. Chinnadurai</b>            |
| 19-12-2018 | Group communication<br>Distributed objects<br><b>Dr. T. Ganesan</b>          | Case study: Enterprise Java Beans<br><b>Dr. T. Ganesan</b>                | Peer-to-peer Systems and Middleware<br><b>Dr. S. Kannan</b> | Overlay case studies<br><b>Dr. S. Kannan</b>                 |
| 20-12-2018 | File service architecture<br>Andrew File system.<br><b>Dr. R. Manivannan</b> | File model – File accessing models<br><b>Dr. R. Manivannan</b>            | Name Space Implementation<br><b>Prof. J. Vanitha</b>        | Name Caches – LDAP<br><b>Prof. J. Vanitha</b>                |
| 21-12-2018 | File sharing semantics<br>naming<br><b>Dr. A. S. Anakath</b>                 | Identifiers, Addresses, Name Resolution<br><b>Dr. A. S. Anakath</b>       | File accessing models<br><b>Dr. R. Manivannan</b>           | File sharing semantics<br>naming<br><b>Dr. R. Manivannan</b> |

**ATTESTED**

  
**Dr. S. RAMABALAN, M.E., Ph.D., CO-ORDINATOR**  
**PRINCIPAL**  
**FDTP on CS6601 – DISTRIBUTED SYSTEMS**  
**EGSPEC**  
 E.G.S. Pillai Engineering College,  
 Thattai, Nagapattinam - 611 002.  
 Email: [naee@egspec.edu.in](mailto:naee@egspec.edu.in)

## Program Schedule

**Subject Name :** Distributed Systems  
**Code No :** CS6601  
**Branch :** Computer Science and Engineering  
**Semester :** VI  
**Duration :** 15/12/2018 – 28/12/2018 (14 days)

### Week Two

| Date       | Session I<br>09-00 – 10.30  | Session II<br>10.45 – 12.15 p.m.  | Session III<br>01.30 p.m. – 03.00 p.m.                           | Session IV<br>03.15 p.m. – 04.45p.m.  |
|------------|---|---|--|---|
| 22-12-2018 | Clocks, events and process states<br><b>Dr. R. Naresh</b>                 | Synchronizing physical clocks<br><b>Dr. R. Naresh</b>                     | Distributed deadlocks Replication<br><b>Dr. S. Senthilkumar</b>  | Case study – Coda<br><b>Dr. S. Senthilkumar</b>                               |
| 23-12-2018 | Synchronizing Logical time and logical clocks<br><b>Dr. P. Pandiaraja</b> | Global states<br><b>Dr. P. Pandiaraja</b>                                 | Process Management<br><b>Dr. S. Senthilkumar</b>                 | Process Migration: Features, Mechanism<br><b>Dr. S. Senthilkumar</b>          |
| 24-12-2018 | Transactions Nested transactions<br><b>Dr. T. Suresh Padmanabhan</b>      | Locks, Optimistic concurrency control<br><b>Dr. T. Suresh Padmanabhan</b> | Threads: Models<br><b>Dr. A. S. Anakath</b>                      | Threads: Issues, Implementation<br><b>Dr. A. S. Anakath</b>                   |
| 25-12-2018 | Resource Management<br><b>Dr. S. Rajakumar</b>                            | Scheduling Algorithms<br><b>Dr. S. Rajakumar</b>                          | Implementing Scheduling Algorithms<br><b>Dr. S. Rajakumar</b>    | Implementing Scheduling Algorithms<br><b>Dr. S. Rajakumar</b>                 |
| 26-12-2018 | Coordination and Agreement<br><b>Dr. N. Murali</b>                        | Distributed mutual exclusion<br><b>Dr. N. Murali</b>                      | Elections<br><b>Dr. N. Murali</b>                                | Distributed Election Algorithms<br><b>Dr. N. Murali</b>                       |
| 27-12-2018 | Timestamp ordering<br><b>Dr. T. Rajagopalan</b>                           | Atomic Commit protocols<br><b>Dr. T. Rajagopalan</b>                      | Task Assignment Approach<br><b>Dr. T. Rajagopalan</b>            | Load Balancing Approach<br><b>Dr. T. Rajagopalan</b>                          |
| 28-12-2018 | Load Sharing Approach<br><b>Prof. R. Kannadasan</b>                       | Review on Distributed Systems<br><b>Prof. R. Kannadasan</b>               | Distributed Computing and Big data<br><b>Prof. R. Kannadasan</b> | Research opportunities in Distributed computing<br><b>Prof. R. Kannadasan</b> |

**ATTESTED**

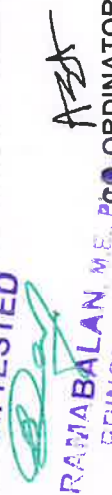
  
**Dr. S. RAMABALAN, M.E., PGD, CO-ORDINATOR**  
 PRINCIPAL  
 E.G.S. Pillay Engineering College,  
 Thiruvalluvar Nagar, Tirunelveli - 611 002.  
 (Dt) Tamil Nadu.

## LIST OF FACULTY EXPERTS AND TOPICS COVERED

FDTP on CS6601 Distributed Systems ( 15/12/2018 –28/12/2018)

| S.No | Faculty Expert Details   | Topics Covered  |
|------|--|---|
| 1.   | Dr. M.Aramudhan,<br>Associate Professor & Head,<br>Department of Information Technology,<br>PKIET, Karaikkal -609603                             | <ul style="list-style-type: none"> <li>• Focus on resource sharing</li> <li>• Challenges of Distributed Systems</li> </ul>  |
| 2.   | Dr. M. Chinnadurai,<br>Professor,<br>School of Computing,<br>E.G.S.Pillay Engineering College,<br>Nagapattinam – 611002.                         | <ul style="list-style-type: none"> <li>• Introduction to Distributed System</li> <li>• Examples of Distributed Systems</li> <li>• Case study: Java RMI</li> </ul>   |
| 3.   | Dr. T. Ganesan,<br>Professor,<br>School of Computing,<br>E.G.S.Pillay Engineering College,<br>Nagapattinam – 611002.                             | <ul style="list-style-type: none"> <li>• Trends in Distributed Systems</li> <li>• Trends in Distributed Systems</li> <li>• Group communication</li> <li>• Distributed objects</li> <li>• Case study: Enterprise Java Beans</li> </ul>         |
| 4.   | Prof. J. Vanitha,<br>Associate Professor,<br>Department of Computer Applications,<br>E.G.S.Pillay Engineering College,<br>Nagapattinam – 611002. | <ul style="list-style-type: none"> <li>• Case study: WWW</li> <li>• Name Space Implementation</li> <li>• Name Caches – LDAP</li> </ul>  |
| 5.   | Dr. M. Azees,<br>Associate Professor,<br>Dept of ECE,<br>VSB College of Engineering,<br>Karur -639111.   | <ul style="list-style-type: none"> <li>• Inter process Communication</li> <li>• Multicast communication</li> <li>• Network virtualization</li> <li>• Case study: MPI</li> </ul>   |
| 6.   | Dr. S. Kannan,<br>Professor,<br>School of Computing,<br>E.G.S.Pillay Engineering College,<br>Nagapattinam – 611002.                              | <ul style="list-style-type: none"> <li>• Request-reply protocols</li> <li>• Remote procedure call</li> <li>• Remote method invocation</li> <li>• Peer-to-peer Systems and</li> <li>• Middleware</li> <li>• Overlay case studies</li> </ul>    |
| 7.   | Dr. R.Manivannan,<br>Associate Professor,<br>School of Computing,<br>E.G.S.Pillay Engineering College,<br>Nagapattinam – 611002.                 | <ul style="list-style-type: none"> <li>• File service architecture</li> <li>• Andrew File system</li> <li>• File model –File</li> <li>• accessing models</li> <li>• File accessing models</li> <li>• File sharing semantics naming</li> </ul> |
| 8.   | Dr. A. S. Anakath,<br>Professor,<br>Department of Computer Applications,<br>E.G.S.Pillay Engineering College,<br>Nagapattinam – 611002.          | <ul style="list-style-type: none"> <li>• File sharing semantics naming</li> <li>• Identifiers, Addresses, Name Resolution</li> <li>• Threads: Models</li> <li>• Threads: Issues, Implementation</li> </ul>                                    |

**ATTESTED**

  
**Dr. S. RAMABALAN, M.E., Ph.D.,**  
**PRINCIPAL**  
 E.G.S. Pillay Engineering College,  
 Thethi, Nagore - 611 002.  
 Nagapattinam (DU) Tamil Nadu



|     |  |   |
|-----|--|---|
| 9.  | Dr. R. Naresh,<br>Associate Professor,<br>School of Computing,<br>SRM University,<br>Kattankulathur-603203   | <ul style="list-style-type: none"> <li>• Clocks, events and process states</li> <li>• Synchronizing physical clocks</li> </ul>  |
| 10. | Dr. S. Senthilkumar,<br>Assistant Professor,<br>Dept of CSE,<br>University College of Engineering<br>Pattukkottai, Rajamadam.                                    | <ul style="list-style-type: none"> <li>• Distributed deadlocks</li> <li>• Replication</li> <li>• Case study – Coda</li> <li>• Process Management</li> <li>• Process Migration: Features, Mechanism</li> </ul>                         |
| 11. | Dr. P. Pandiaraja,<br>Department of Computer Science and<br>Engineering,<br>Associate Professor,<br>M. Kumarasamy College of Engineering<br>Karur - 639113       | <ul style="list-style-type: none"> <li>• Synchronizing Logical time and logical clocks</li> <li>• Global states</li> </ul>  |
| 12. | Dr.T.Suresh Padmanabhan,<br>Professor,<br>Department of Electical and Electronics<br>Engineering,<br>E.G.S.Pillay Engineering College,<br>Nagapattinam – 611002. | <ul style="list-style-type: none"> <li>• Transactions</li> <li>• Nested transactions</li> <li>• Locks, Optimistic concurrency control</li> </ul>  |
| 13. | Dr. S. Rajakumar,<br>Assistant Professor & Head,<br>Department of Mathematics,<br>University College of Engineering,<br>Ariyalur - 621704                        | <ul style="list-style-type: none"> <li>• Resource Management</li> <li>• Scheduling Algorithms</li> <li>• Implementing</li> <li>• Scheduling Algorithms</li> <li>• Implementing</li> <li>• Scheduling Algorithms</li> </ul>            |
| 14. | Dr. N.Murali,<br>Associate Professor,<br>School of Computing,<br>E.G.S.Pillay Engineering College,<br>Nagapattinam – 611002.                                     | <ul style="list-style-type: none"> <li>• Coordination and Agreement</li> <li>• Distributed mutual exclusion</li> <li>• Elections</li> <li>• Distributed Election Algorithms</li> </ul>  |
| 15. | Dr. T. Rajagopalan,<br>Assistant Professor ,<br>Department of Mathematics,<br>University College of Engineering,<br>Ariyalur - 621704                            | <ul style="list-style-type: none"> <li>• Timestamp ordering</li> <li>• Atomic Commit protocols</li> <li>• Task Assignment Approach</li> <li>• Load Balancing Approach</li> </ul>  |
| 16. | Prof. R. Kannadasan,<br>Assistant Professor (Sr. Grade),<br>School of Computing,<br>VIT University,<br>Vellore - 632014  | <ul style="list-style-type: none"> <li>• Load Sharing Approach</li> <li>• Reviw on Distributed</li> <li>• Systems</li> <li>• Distributed Computing and Big data</li> <li>• Research opportunities in Distributed computing</li> </ul> |

**ATTESTED**  
  
**Dr. S. RAMABALAN, M.E., Ph.D.,**  
**PRINCIPAL**  
**E.G.S. Pillay Engineering College,**  
**Thethi, Nagore - 611 002,**  
**Nagapattinam (Dt) Tamil Nadu.**



## TWO WEEKS FDTP

ON

## CS6601 – Distributed Systems

15-12-2018 to 28-12-2018

## REGISTRATION FORM

### COORDINATORS

**Dr. A. S. ANAKATH**

**Mr. M. RAJAKUMARAN**



Approved by

**Anna University, Chennai -25**

Organized by



DEPARTMENT OF CSE & MCA

E.G.S. Pillay Engineering College

(An Autonomous Institution)

Affiliated to Anna University, Chennai

Nagapattinam – 611 002.

www.egspec.org.

## ORGANIZING COMMITTEE

### CHIEF PATRON:

**Dr. M. K. Surappa**  
Vice-Chancellor  
Anna University  
Chennai

### PATRON:

**Dr. J. Kumar**  
Registrar  
Anna University  
Chennai

### CHAIR:

**Dr.D. Sridharan**  
Director, CFD

**Dr. I. Arul Aram**  
Addl. Director, CFD

### CO CHAIRS:

**Shri. S. Paramesvaran**  
Secretary, E.G.S.P GOI.

**Dr. S. Ramabalan**  
Principal, E.G.S.P.E.C.

**Dr. M. Chinnadurai**  
HOD/CSE, E.G.S.P.E.C.

**Prof. J. Vanitha**  
HOD/MCA, E.G.S.P.E.C.

### COORDINATORS:

**Dr. A. S. Anakath**  
Department of MCA

**Prof. M. Rajakumar**  
Department of CSE

Venue: A/C Seminar Hall, PG Block

### IMPORTANT DATES

Submission of Application : 10/12/2018

Intimation of Selection : 12/12/2018

Confirmation by Participants : 13/12/2018

## REGISTRATION FORM

Name :  
Designation :  
Qualification :  
E-mail :  
Mobile no. :  
DOB and Age :  
Institution address :  
Communication address :

I declare that the details furnished above are true to the best of my knowledge and belief and agreed to abide by the rules and regulations governing the conduct of faculty development training program sponsored by Centre for Faculty Development Anna University, Chennai.

Signature of Applicant

## SPONSORSHIP CERTIFICATE

Certified that Dr. /Prof. /Mr. /Mrs.

is a bonafide faculty member of our Engineering College. He /She is identified to teach the subject Distributed Systems". He/She is sponsored to attend this FDTP programme from 15<sup>th</sup> Dec -28<sup>th</sup>

**ATTESTED**  
**Dr. S. RAMABALAN**  
PRINCIPAL

E.G.S. Pillay Engineering College,  
Thethi, Nagore - 611 002.

Nagapattinam (dt) Tamil Nadu.

Place:

Signature & Seal of the Principal

### About the Institution

E.G.S Pillay Engineering College is one of the pioneering non - grant engineering colleges in the state. It was established by the E.G.S Pillay and Sons Educational and Charitable Trust, Nagapattinam, in the year 1995 with the sanction of the Government of Tamilnadu, approval of the All India Council for Technical Education, New Delhi and affiliation to Anna University, Chennai. The Institution was recognized with UGC Act 2(f) &12(B) and accredited by NAAC with 'A' Grade and NBA for three Programmes (B.E-CSE/EEE/MECH). Our college is granted with autonomous status by University Grants Commission, New Delhi and by Anna University, Chennai from the academic year 2017-2018 onwards.

### Department Profile

The department of Computer Applications focuses on making industry ready IT professionals by imparting quality computer education along with excellent interpersonal skills. It was started in the year 2001 and offers 3 years full time MCA course to the students. Department of Computer Science & Engineering Started in the year 1995. It offers B.E. and M.E. in Computer Science and Engineering. In the year 2016, B.E CSE Programme was accredited by NBA.

### About the Course

Distributed Systems is a core course in Computer Science and Engineering streams. This programme is designed to discuss the various trends in Distributed Systems and provides an in-depth understanding of fundamental principles, models, algorithms and issues involved in building Distributed Systems.

### Course Contents

- Introduction
- Communication in Distributed System
- Network Virtualization
- Remote Method Invocation and Objects
- Peer to Peer Services
- File System
- Naming
- Synchronization
- Replication
- Process Management
- Resource Management
- Case Studies

### Resource Persons

The sessions will be handled by experts from Academia, Universities, Research organizations and industry in the Subject area.

### Eligibility

Faculty of Engineering Colleges affiliated to Anna University Chennai.

### Guidelines

- ✓ No participant fees will be collected.
- ✓ Faculty from Affiliated Engineering Colleges of Anna University are only eligible.
- ✓ Session time will be from 09 AM to 4:45 PM
- ✓ Total number of participants is strictly 25
- ✓ Eligible participants will be selected based on first come first serve basis.

### For Details Contact

The Coordinator(s),  
FDTP on Distributed Systems  
Department of CSE & MCA  
E.G.S.Pillay Engineering College  
Nagapattinam -611002.

**E-mail:** fdtp2018ds@gmail.com  
**Mobile No:** 9486433704, 9952127506.

ATTESTED  
  
S. RAMABALAN, M.E., Ph.D.,  
PRINCIPAL  
E.G.S. Pillay Engineering College,  
Therhi Nagore - 611 002,  
Nagapattinam (TN) Tamil Nadu.

**TWO WEEKS FDTP  
ON  
CS6601 – Distributed System  
15-12-2018 to 28-12-2018**

**REGISTRATION FORM**

**COORDINATORS**

**Dr. A. S. ANAKATH**

**Mr. M. RAJAKUMARAN**



Approved by

**Anna University, Chennai -25**

Organized by



**DEPARTMENT OF CSE & MCA**  
**E.G.S. Pillay Engineering College**  
(An Autonomous Institution)

Affiliated to Anna University, Chennai  
Nagapattinam – 611 002.

[www.egspec.org](http://www.egspec.org)

**ORGANIZING COMMITTEE**

**CHIEF PATRON:**

**Dr. M. K. Surappa**  
Vice-Chancellor  
Anna University  
Chennai

**PATRON:**

**Dr. J. Kumar**  
Registrar  
Anna University  
Chennai

**CHAIR:**

**Dr.D. Sridharan**  
Director, CFD

**Dr. I. Arul Aram**  
Addl. Director, CFD

**CO CHAIRS:**

**Shri. S. Parameswaran**  
Secretary, E.G.S.P GOI.

**Dr. S. Ramabalan**  
Principal, E.G.S.P.E.C.

**Dr. M. Chinnadurai**  
HOD/CSE, E.G.S.P.E.C.

**Prof. J. Vanitha**  
HOD/MCA, E.G.S.P.E.C.

**COORDINATORS:**

**Dr. A. S. Anakath**  
Department of MCA

**Prof. M. Rajakumaran**  
Department of CSE

**Venue: A/C Seminar Hall, PG Block**

**IMPORTANT DATES**

Submission of Application : 10/12/2018

Intimation of Selection : 12/12/2018

Confirmation by Participants : 13/12/2018

**REGISTRATION FORM**

Name

Dem - G. Kavitha

Designation

: AP/CSE

Qualification

: Ph-D.

E-mail

: mgkavitha@gmail.com

Mobile no.

: 9994703151

DOB and Age

: 10.07.1976/42

Institution address

: University College  
of Engg - Pattukkottai

Communication address

: Dept. of CSE  
VCE/ECT, Rajamadam

I declare that the details furnished above

are true to the best of my knowledge and belief  
and agreed to abide by the rules and regulations  
governing the conduct of faculty development  
training program sponsored by Centre for  
Faculty Development Anna University, Chennai.

M - G - Kavitha  
Signature of Applicant

**SPONSORSHIP CERTIFICATE**

Certified that Dr. /Prof. /Mr. /Mrs.

M - G - Kavitha

is a bonafide faculty member of our Engineering  
College. He /She is identified to teach the subject  
"Distributed System". He/She is sponsored to  
attend this FDTP programme from 15<sup>th</sup> Dec -28<sup>th</sup>  
Dec 2018.

ATTESTED  
Dr. S. RAMABALAN, M.E., Ph.D.  
PRINCIPAL  
E.G.S. Pillay Engineering College  
Thethri, Nagore - 611 002  
Nagapattinam (Dist. Thanjavur,  
Tamil Nadu)

Signature & Seal of the Principal  
Anna University, Chennai  
Date: 12/12/2018  
Place: Rajahmundry, Andhra Pradesh  
Pattukkottai



## TWO WEEKS FDTP

ON

CS6601 – Distributed System

15-12-2018 to 28-12-2018

## REGISTRATION FORM

### COORDINATORS

Dr. A. S. ANAKATH

Mr. M. RAJAKUMARAN



Approved by

Anna University, Chennai -25

Organized by



DEPARTMENT OF CSE & MCA

E.G.S. Pillay Engineering College

(An Autonomous Institution)

Affiliated to Anna University, Chennai

Nagapattinam – 611 002.

[www.egspec.org](http://www.egspec.org)

## ORGANIZING COMMITTEE

### CHIEF PATRON:

Dr. M. K. Surappa  
Vice-Chancellor  
Anna University  
Chennai

### PATRON:

Dr. J. Kumar  
Registrar  
Anna University  
Chennai

### CHAIR:

Dr. D. Sridharan  
Director, CFD

Dr. I. Arul Aram  
Addl. Director, CFD

### CO CHAIRS:

Shri. S. Parameswaran  
Secretary, E.G.S.P.GOI.

Dr. S. Ramabalan  
Principal, E.G.S.P.E.C.

Dr. M. Chinmudurai  
HOD/CSE, E.G.S.P.E.C.

Prof. J. Vanitha  
HOD/MCA, E.G.S.P.E.C.

### COORDINATORS:

Dr. A. S. Anakath  
Department of MCA

Prof. M. Rajakumaran  
Department of CSE

Venue: A/C Seminar Hall, PG Block

### IMPORTANT DATES ATTESTED

Submission of Application : 10/12/2018

Intimation of Selection : 12/12/2018

Confirmation : 15/12/2018. E... Ph

PRINCIPAL

E.G.S. Pillay Engineering College

Thethi, Nagore - 611 002.

Nagapattinam (Dt) Tamil Nadu.

## REGISTRATION FORM

Name : Dr. B. RAJESH  
Designation : Asst. Professor  
Qualification : M.Sc., M.Phil, Ph.D  
E-mail : rajesh-rab@yahoo.co.in  
Mobile no. : 7639073860  
DOB and Age : 06.07.1976, 42  
Institution address : UCE Pattukkottai  
Communication address : Rajamadam, Pattukkottai, 614701

I declare that the details furnished above are true to the best of my knowledge and belief and agreed to abide by the rules and regulations governing the conduct of faculty development training program sponsored by Centre for Faculty Development Anna University, Chennai.

B. Rajesh  
Signature of Applicant

## SPONSORSHIP CERTIFICATE

Certified that Dr. /Prof. /Mr. /Mrs.

B. RAJESH

is a bonafide faculty member of our Engineering College. He /She is identified to teach the subject "Distributed System". He/She is sponsored to attend this FDTP programme from 15<sup>th</sup> Dec -28<sup>th</sup> Dec 2018.

B. Rajesh  
Signature & Seal of the Principal  
Date : 17.12.2018



B. Rajesh  
Signature & Seal of the Principal  
Date : 17.12.2018

B. Rajesh  
Signature & Seal of the Principal  
Date : 17.12.2018

B. Rajesh  
Signature & Seal of the Principal  
Date : 17.12.2018

B. Rajesh  
Signature & Seal of the Principal  
Date : 17.12.2018

B. Rajesh  
Signature & Seal of the Principal  
Date : 17.12.2018

B. Rajesh  
Signature & Seal of the Principal  
Date : 17.12.2018



# TWO WEEKS FDTP ON

## CS6601 – Distributed System 15-12-2018 to 28-12-2018

### REGISTRATION FORM

#### COORDINATORS

**Dr. A. S. ANAKATH**

**Mr. M. RAJAKUMARAN**



Approved by

**Anna University, Chennai -25**

Organized by



**DEPARTMENT OF CSE & MCA**

**E.G.S. Pillay Engineering College  
(An Autonomous Institution)**

Affiliated to Anna University, Chennai  
Nagapattinam – 611 002.

[www.egspec.org](http://www.egspec.org)

### ORGANIZING COMMITTEE

#### CHIEF PATRON:

**Dr. M. K. Surappa**  
Vice-Chancellor  
Anna University  
Chennai

#### PATRON:

**Dr. J. Kumar**  
Registrar  
Anna University  
Chennai

#### CHAIR:

**Dr.D. Sridharan**  
Director, CFD

**Dr. I. Arul Aram**

**Addl. Director, CFD**

#### CO CHAIRS:

**Shri. S. Paramesvaran**  
Secretary, E.G.S.P.GOI.

**Dr. S. Ramabalan**  
Principal, E.G.S.P.E.C.

**Dr. M. Chinnadurai**  
HOD/CSE, E.G.S.P.E.C.

**Prof. J. Vanitha**  
HOD/MCA, E.G.S.P.E.C.

#### COORDINATORS:

**Dr. A. S. Anakath.**  
Department of MCA

**Prof. M. Rajakumaran**  
Department of CSE

Venue: A/C Seminar Hall, PG Block

**IMPORTANT DATES**  
Submission of Application : 10/12/2018  
Information of Selection : 12/12/2018  
Confirmation by Participants : 13/12/2018

ATTESTED

**Dr. S. Ramabalan**

PRINCIPAL,  
E.G.S. Pillay Engineering College,  
Nagapattinam - 611 002

Dec 12, 2018

Signature of the Principal

Place: Nagapattinam

### REGISTRATION FORM

Name : **Dr. S. Senthil Kumar**  
Designation : **Asst. CSE**  
Qualification : **M.E. Ph.D**  
E-mail : **Senthilvce.pke@gmail.com**  
Mobile no. : **9976176272**  
DOB and Age : **29/11/73**  
Institution address : **UCE-Patel & Venkatesh**  
Communication address : **Raja Madan 614701**

I declare that the details furnished above are true to the best of my knowledge and belief and agreed to abide by the rules and regulations governing the conduct of faculty development training program sponsored by Centre for Faculty Development Anna University, Chennai.

**Signature of Applicant**

### SPONSORSHIP CERTIFICATE

Certified that Dr. /Prof. /Mr. /Mrs.

**S. S. SENTHIL KUMAR**

is a bonafide faculty member of our Engineering College. He /She is identified to teach the subject "Distributed System". He/She is sponsored to attend this FDTP programme from 15<sup>th</sup> Dec -28<sup>th</sup> Dec 2018.

Dec 2018.

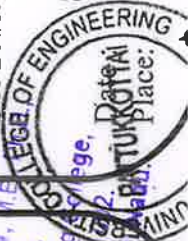

Signature & Seal of the Principal

Anna University: Chennai

University College of Engineering

Patrukkottai

**TWO WEEKS FDTP  
ON  
CS6601 – Distributed System  
15-12-2018 to 28-12-2018**

**REGISTRATION FORM**

**COORDINATORS**

**Dr. A. S. ANAKATH  
Mr. M. RAJAKUMARAN**



Approved by  
**Anna University, Chennai -25**  
Organized by



**DEPARTMENT OF CSE & MCA  
E.G.S. Pillay Engineering College  
(An Autonomous Institution)  
Affiliated to Anna University, Chennai  
Nagapattinam – 611 002.  
www.egscec.org.**

**ORGANIZING COMMITTEE**

**CHIEF PATRON:**  
Dr. M. K. Surappa  
Vice-Chancellor  
Anna University  
Chennai

**PATRON:**  
Dr. J. Kumar  
Registrar  
Anna University  
Chennai

**CHAIR:**  
Dr. D. Sridharan  
Director, CFD

**CO CHAIRS:**  
Dr. I. Arul Aram  
Addl. Director, CFD

Shri. S. Paramesvaran  
Secretary, E.G.S.P GOI.  
Dr. S. Ramabalan  
Principal, E.G.S.P.E.C.  
Dr. M. Chinnadurai  
HOD/CSE, E.G.S.P.E.C.  
Prof. J. Vanitha  
HOD/MCA, E.G.S.P.E.C.

**COORDINATORS:**

Dr. A. S. Anakath  
Department of MCA

Prof. M. Rajakumaran  
Department of CSE

**Venue: A/C Seminar Hall, RG Block**

**IMPORTANT DATES**  
Dr. S. RAMABALAN, M. RAJAKUMARAN  
PRINCIPAL  
Submission of Application: 10/12/2018  
Intimation of Selection: 11/12/2018  
Confirmation by Participants: 12/12/2018



**REGISTRATION FORM**

Name : **K. PREEETHI**  
Designation : **AP/CSE**  
Qualification : **M.E CSE (Ph.d)**  
E-mail : **Kalai.Peeethi@gmail.com**  
Mobile no. : **9790263717**  
DOB and Age : **30.06.1984 + 35**  
Institution address : **UCE PKT**  
Communication address : **Anna University**

I declare that the details furnished above are true to the best of my knowledge and belief and agreed to abide by the rules and regulations governing the conduct of faculty development training program sponsored by Centre for Faculty Development Anna University, Chennai.

Signature of Applicant

**SPONSORSHIP CERTIFICATE**

Certified that Dr. /Prof./Mr. /Mrs.  
**K. PREEETHI AP/CSE**

is a bonafide faculty member of our Engineering College. He /She is identified to teach the subject "Distributed System". He/She is sponsored to attend this FDTP programme from 15<sup>th</sup> Dec -28<sup>th</sup>

Signature of the Principal  
Anna University, Chennai  
Place: Nagapattinam



# TWO WEEKS FDTP

ON

## CS6601- Distributed System

15-12-2018 to 28-12-2018

### REGISTRATION FORM

#### COORDINATORS

Dr. A. S. ANAKATH

Mr. M. RAJAKUMARAN



Approved by

Anna University, Chennai -25

Organized by



DEPARTMENT OF CSE & MCA

E.G.S. Pillay Engineering College  
(An Autonomous Institution)

Affiliated to Anna University, Chennai  
Nagapattinam - 611 002.

www.egspec.org.

#### ORGANIZING COMMITTEE

##### CHIEF PATRON:

Dr. M. K. Surappa  
Vice-Chancellor  
Anna University  
Chennai

##### PATRON:

Dr. J. Kumar  
Registrar  
Anna University  
Chennai

##### CHAIR:

Dr. D. Sridharan  
Director, CFD

Dr. I. Arul Aram

Addl. Director, CFD

##### CO CHAIRS:

Shri. S. Paramesvaran  
Secretary, E.G.S.P GOI.

Dr. S. Ramabalan  
Principal, E.G.S.P.E.C.

Dr. M. Chinnadurai  
HOD/CSE, E.G.S.P.E.C.

Prof. J. Vanitha  
HOD/MCA, E.G.S.P.E.C.

##### COORDINATORS:

Dr. A. S. Anakath  
Department of MCA

Prof. M. Rajakumar  
Department of CSE

Venue: A/C Seminar Hall, **BG Block**  
**E.G.S. PILLAY ENGINEERING COLLEGE**  
NAGAPATTINAM  
PRINCIPAL  
E.G.S. Pillay Engineering College -  
: 10/12/2018  
: 12/23/2018  
Confirmation by Participants : 13/12/2018

ATTESTED

**E.G.S. PILLAY ENGINEERING COLLEGE**  
NAGAPATTINAM  
PRINCIPAL  
Place: Nagapattinam



### REGISTRATION FORM

Name : Dr. A. KAVITHA  
Designation : AP / Maths  
Qualification : M.Sc., M.Phil., Ph.D.  
E-mail : kavitha977@yahoo.  
Mobile no. : 9994159474  
DOB and Age : 21.6.77; 41  
Institution address : ULE PKT  
Communication address : U.E. Patinukottai  
Rajamadam

I declare that the details furnished above are true to the best of my knowledge and belief and agreed to abide by the rules and regulations governing the conduct of faculty development training program sponsored by Centre for Faculty Development Anna University, Chennai.

Signature of Applicant

#### SPONSORSHIP CERTIFICATE

Certified that Dr. /Prof. /Mr. /Mrs. A. KAVITHA, AP / Maths is a bonafide faculty member of our Engineering College. He /She is identified to teach the subject "Distributed System". He/She is sponsored to attend this FDTP programme from 15<sup>th</sup> Dec -28<sup>th</sup>



Signature of **DEAN**  
**Anna University, Chennai**  
Principal  
University College of Engineering  
Nagapattinam

D... .. 611 701

## REGISTRATION FORM

Name = Miss. E. SARANYA  
Designation = AP/CSE  
Qualification = ME (CSE)  
E-mail = saranyaedumban@gmail.com  
Mobile no. = 9787599549  
DOB and Age = 14-04-1990, 28 YRS  
Institution address = SIR ISSAC NEWTON COLLEGE OF  
Communication address = ENGG AND TECH.  
2/103, SINGARAVELAR STREET, THARANGAM, 609 313

I declare that the details furnished above are true to the best of my knowledge and belief and agreed to abide by the rules and regulations governing the conduct of faculty development training program sponsored by Centre for Faculty Development Anna University, Chennai.

  
Signature of Applicant

## SPONSORSHIP CERTIFICATE

Certified that Dr. /Prof. /Mr. /Mrs.

Miss. E. SARANYA

is a bonafide faculty member of our Engineering College. He /She is identified to teach the subject "Distributed System". He/She is sponsored to attend this FDIP programme from 15<sup>th</sup> Dec -28<sup>th</sup> Dec 2018.

  
Signature & Seal of the Principal

PRINCIPAL

Sir Issac Newton College  
of Engineering and Technology  
Pannakovil, Nagapattinam - 611 102.

Date : 12-12-18

Place: NAGAPATTINAM

ATTESTED

  
Dr. S. RAMABALAN, M.E., Ph.D.,  
PRINCIPAL

E.G.S. Pillay Engineering College,  
Thethi, Nagore - 611 002

(Dt) Tam



## REGISTRATION FORM

Name : A. INDIRA DEVI  
Designation : Assistant professor  
Qualification : M.E (CSE)  
E-mail : indu.cutie@gmail.com  
Mobile no. : 8098833207  
DOB and Age : 21.11.1984 & 34 years  
Institution address : SINCET, NAGAR  
Communication address : 214/1, North street, Vadakandam  
Thiruvananthapuram - 610104.

I declare that the details furnished above are true to the best of my knowledge and belief and agreed to abide by the rules and regulations governing the conduct of faculty development training program sponsored by Centre for Faculty Development Anna University, Chennai.

*A. Indira Devi*  
Signature of Applicant

## SPONSORSHIP CERTIFICATE

Certified that ~~Dr./Prof./Mr./Mrs.~~

A. INDIRA DEVI

is a bonafide faculty member of our Engineering College. He /She is identified to teach the subject "Distributed System". He/She is sponsored to attend this FDTP programme from 15<sup>th</sup> Dec -28<sup>th</sup> Dec 2018.

*[Signature]*  
Signature & Seal of the Principal

Date : 12-12-2018  
Place : NALAPATTINAM

PRINCIPAL  
Sir Issac Newton College  
of Engineering and Techno.  
Pappakoyil, Nagapattinam - 611 102

ATTESTED  
*[Signature]*  
Dr. S. RAMABALAN, M.E., Ph.D.  
PRINCIPAL  
E.G.S. Pillay Engineering College,  
Thethi, Nagore - 611 002.  
nalapattinam@annauniv.edu

## REGISTRATION FORM

Name : G. SARANYA  
Designation : AP  
Qualification : M.Tech (CSE)  
E-mail : saran.lakami@gmail.com  
Mobile no. : 9786972988  
DOB and Age : 19.06.89 and 29  
Institution address : 8217, Sir Isaac Newton College of  
Engg & Tech.  
Communication address : 18B, Salaji Nagar, Thiruvananthapuram.

I declare that the details furnished above are true to the best of my knowledge and belief and agreed to abide by the rules and regulations governing the conduct of faculty development training program sponsored by Centre for Faculty Development Anna University, Chennai.

  
Signature of Applicant

## SPONSORSHIP CERTIFICATE

Certified that Dr. /Prof. /Mr. /Mrs.

Ms. G. SARANYA

is a bonafide faculty member of our Engineering College. He /She is identified to teach the subject "Distributed System". He/She is sponsored to attend this FDTP programme from 15<sup>th</sup> Dec -28<sup>th</sup> Dec 2018.

  
Signature & Seal of the Principal

  
Date : 12/12/18  
Place : NAGAPATTINAM.

PRINCIPAL  
Sir Isaac Newton College  
of Engineering and Technology  
Pappakovil, Nagapattinam - 611 002.

ATTESTED  
  
Dr. S. RAMABALAN, M.E., Ph.D.,  
PRINCIPAL  
E.G.S. Pillay Engineering College,  
Thethi, Nagore - 611 002,  
Nagapattinam (Dt) Tamil Nadu.



**TWO WEEKS FDTP  
ON**

**CS6601 – Distributed System  
15-12-2018 to 28-12-2018**

**REGISTRATION FORM**

**COORDINATORS**

**Dr. A. S. ANAKATHI  
Mr. M. RAJAKUMARAN**



Approved by  
**Anna University, Chennai -25**  
Organized by



DEPARTMENT OF CSE & MCA  
E.G.S. Pillay Engineering College  
Thiruthi. Nellore - 611 002.

**ORGANIZING COMMITTEE**

**CHIEF PATRON:**

Dr. M. K. Surappa  
Vice-Chancellor  
Anna University  
Chennai

**PATRON:**

Dr. J. Kumar  
Registrar  
Anna University  
Chennai

**CHAIR:**

Dr. D. Sridharan  
Director, CFD

Dr. I. Arul Aram  
Addl. Director, CFD

**CO CHAIRS:**

Shri. S. Paramasivaram  
Secretary, E.G.S.P.GOI.  
Dr. S. Karubalan  
Principal, E.G.S.P.F.C.  
Dr. M. Chinnadurai  
HOD/CSE, E.G.S.P.E.C.  
Prof. J. Vanitha  
HOD/MCA, E.G.S.P.E.C.

**COORDINATORS:**

Dr. A. S. Anakathi  
Department of MCA  
Prof. M. Rajakumarani  
Department of CSE

Venue: A/C Seminar Hall, PG Block

**IMPORTANT DATES**  
Submission of Applications : 15/12/2018  
Publication of Selection : 17/12/2018  
Confirmation by Participants : 18/12/2018

**REGISTRATION FORM**

Name : **M. MOHAMED FAISAL**  
Designation : **Asst. Prof / CSE**  
Qualification : **M.E., CSE**  
E-mail : **faisal.cse@annauniv.edu**  
Mobile no. : **9688110199**  
DOB and Age : **16.07.1985 &**  
Institution address : **SRVEC, SEMBODAI - 614609,**  
Communication address : **VEDARANIYAM T.K.T.,  
NAGAPATTINAM D.T.**

I declare that the details furnished above are true to the best of my knowledge and belief and agreed to abide by the rules and regulations governing the conduct of faculty development training program sponsored by Centre for Faculty Development Anna University, Chennai.

*Faisal*  
Signature of Applicant

**SPONSORSHIP CERTIFICATE**

Certified that **Dr. /Prof. /Mr. /Mrs.**

**M. MOHAMED FAISAL AP/CSE**

is a bonafide faculty member of our Engineering College. He /She is identified to teach the subject "**Distributed System**". He/She is sponsored to attend this FDTP programme from 15<sup>th</sup> Dec -28<sup>th</sup>

Dec 2018, **M.E., Ph.D.**

*[Signature]*  
**Dr. S. RAMABALAN,**  
PRINCIPAL

E.G.S. Pillay Engineering College,  
Thiruthi. Nellore - 611 002.

**Engineering College**  
Sembodai - 614 608,  
Nagapattinam Dt.

**TWO WEEKS FDTP  
ON**

**CS6601 – Distributed System  
15-12-2018 to 28-12-2018**

**REGISTRATION FORM**

**COORDINATORS**

**Dr. A. S. ANAKATH**

**Mr. M. RAJAKUMARAN**



Approved by  
**Anna University, Chennai -25**  
Organized by



**DEPARTMENT OF CSE & MCA**  
**E.G.S. Pillay Engineering College**  
(An Autonomous Institution)  
Affiliated to Anna University, Chennai  
Nagapattinam – 611 002.  
[www.egspec.org](http://www.egspec.org).

**ORGANIZING COMMITTEE**

**CHIEF PATRON:**

**Dr. M. K. Surappa**  
Vice-Chancellor  
Anna University  
Chennai

**PATRON:**

**Dr. J. Kumar**  
Registrar  
Anna University  
Chennai

**CHAIR:**

**Dr. D. Sridharan**  
Director, CFD

**Dr. I. Arul Aram**

**Addl. Director, CFD**

**CO CHAIRS:**

**Shri. S. Paramesvaran**  
Secretary, E.G.S.P GOI.

**Dr. S. Ramabalan**  
Principal, E.G.S.P.E.C.

**Dr. M. Chinnadurai**  
HOD/CSE, E.G.S.P.E.C.

**Prof. J. Vanitha**  
HOD/MCA, E.G.S.P.E.C.

**COORDINATORS:**

**Dr. A. S. Anakath**  
Department of MCA

**Prof. M. Rajakumaran**  
Department of CSE

**Venue: A/C Seminar Hall, PG Block**

**IMPORTANT DATES**

Submission of Application : 10/12/2018  
Intimation of Selection : 12/12/2018  
Confirmation by Participants : 13/12/2018

**REGISTRATION FORM**

Name : **M. VENKATESHWARAN**  
Designation : **Asst. Professor /CSE**  
Qualification : **M.E.,**  
E-mail : **mkvengatesh@gmail.com**  
Mobile no. : **9940857074**  
DOB and Age : **27-07-1993 & 25**  
Institution address : **ARASU ENGINEERING COLLEGE**

Communication address : **M1, Meckapudugai, Keshavnagar  
(Kuttalambur) - Nagapattinam (TN)**

I declare that the details furnished above  
are true to the best of my knowledge and belief  
and agreed to abide by the rules and regulations  
governing the conduct of faculty development  
training program sponsored by Centre for  
Faculty Development Anna University, Chennai.

**M. Venkateshwaran**  
Signature of Applicant

**SPONSORSHIP CERTIFICATE**

Certified that **Dr. /Prof. /Mr. /Mrs.**

**M. VENKATESHWARAN**

is a bonafide faculty member of our Engineering  
College. He /She is identified to teach the subject  
"Distributed System". He/She is sponsored to  
attend this FDTP programme from 15<sup>th</sup> Dec -28<sup>th</sup>  
Dec 2018.

**M. Venkateshwaran**  
Signature of Principal

**Dr. S. Ramabalan**  
Principal  
**E.G.S. Pillay Engineering College**  
Nagapattinam - 611 002.  
Date: 14/12/2018  
Place: **Nagapattinam**  
KUMBakonam.



REGISTRATION FORM

Name : SATHYA V  
Designation : ASSISTANT PROFESSOR/CSE  
Qualification : M.E. (Ph.D.)  
E-mail : sathya@avcce.net  
Mobile no. : 9952127506  
DOB and Age : 14/06/1988  
Institution address : AVC College of Engg.,  
Mannampandal  
Communication address : Dept of CSE,  
AVCCCE - Mannampandal  
Myladuthurai

I declare that I am willing to attend this FDTP programme on CS6601- Distributed System from 15th Dec - 28th Dec 2018.

I declare that the details furnished above are true to the best of my knowledge and belief and agreed to abide by the rules and regulations governing the conduct of faculty development training program sponsored by Centre for Faculty Development Anna University, Chennai.

  
Signature of Applicant

Date : 13/12/18

Place:

**ATTESTED**  
  
Dr. S. RAMABEEN, M.E., Ph.D.  
PRINCIPAL  
E.G.S. Pillay Engineering College,  
Thethi, Nagore - 611 002  
Nagapattinam (Dt) Tamil Nadu

# TWO WEEKS FDTP

ON

## CS6601 – Distributed System

15-12-2018 to 28-12-2018

### REGISTRATION FORM

#### COORDINATORS

Dr. A. S. ANAKATH

Mr. M. RAJAKUMARAN



Approved by  
Anna University, Chennai -25

Organized by



DEPARTMENT OF CSE & MCA  
E.G.S. Pillay Engineering College  
(An Autonomous Institution)

Affiliated to Anna University, Chennai  
Nagapattinam - 611 002.

www.egseece.org

#### ORGANIZING COMMITTEE

##### CHIEF PATRON:

Dr. M. K. Surappa  
Vice-Chancellor  
Anna University  
Chennai

##### PATRON:

Dr. J. Kunnar  
Registrar  
Anna University  
Chennai

##### CHAIR:

Dr. D. Sridharan  
Director, CFD

Dr. I. Arul Aram  
Addl. Director, CFD

##### CO CHAIRS:

Shri. S. Parameswaran  
Secretary, E.G.S.P. GOL.

Dr. S. Ramabalan  
Principal, E.G.S.P.E.C.

Dr. M. Chinnadurai  
HOD/CSE, E.G.S.P.E.C.

Prof. J. Vaitiba  
HOD/MCA, E.G.S.P.E.C.

##### COORDINATORS:

Dr. A. S. Anakath  
Department of MCA

Prof. M. Rajakumaran  
Department of CSE

Venue: A/C Seminar Hall, PG Block

##### IMPORTANT DATES

Submission of Application : 10/12/2018  
Intimation of Selection : 12/12/2018  
Confirmation by Participant : 15/12/2018

### REGISTRATION FORM

Name : B.N.KARTHIK  
Designation : Assistant Professor -IT  
Qualification : M.Tech  
E-mail : jayamkarthik65@gmail.com  
Mobile no. : 9884417734  
DOB and Age : 16/06/1985 & 33  
Institution address : A.V.C. College of Engg, Thanjavur  
Communication address : Dept. of IT  
AVCEE.

I declare that the details furnished above are true to the best of my knowledge and belief and agreed to abide by the rules and regulations governing the conduct of faculty development training program sponsored by Centre for Faculty Development Anna University, Chennai.

  
Signature of Applicant

#### SPONSORSHIP CERTIFICATE

Certified that Dr./Prof./Mr./Mrs.

B.N.KARTHIK, AP/IT

is a bonafide member of our Engineering College. He /She is identified to teach the subject "Distributed System". He/She is sponsored to attend this FDTP programme from 15<sup>th</sup> Dec -28<sup>th</sup> Dec 2018.

**ATTENDED**

  
Dr. S. RAMABALAN, M.E., Ph.D.  
PRINCIPAL

Signature & Seal of the Principal  
Date: 16/12/18  
Place: Nagapattinam  
Principal  
HEAD OF THE DEPARTMENT  
DEPARTMENT OF MCA  
Nagapattinam

# TWO WEEKS FDTP

ON

## CS6601 – Distributed System

15-12-2018 to 28-12-2018

### REGISTRATION FORM

#### COORDINATORS

**Dr. A. S. ANAKATHI**

**Mr. M. RAJAKUMARAN**



Approved by

**Anna University, Chennai -25**

Organized by



DEPARTMENT OF CSE & MCA  
E.G.S. Pillay Engineering College  
(An Autonomous Institution)

Affiliated to Anna University, Chennai  
Nagapattinam – 611 002.

www.egspec.org

#### ORGANIZING COMMITTEE

##### CHIEF PATRON:

Dr. M. K. Surappa  
Vice-Chancellor  
Anna University  
Chennai

##### PATRON:

Dr. J. Kumar  
Registrar  
Anna University  
Chennai

##### CHAIR:

Dr. D. Sridharan  
Director, CFD

Dr. I. Arul Aram  
Addl. Director, CFD

##### CO CHAIRS:

Shri. S. Parameswaran  
Secretary, E.G.S.P GOI.

Dr. S. Ramabalan  
Principal, E.G.S.P.E.C.

Dr. M. Chinnadurai  
HOD/CSE, E.G.S.P.E.C.

Prof. J. Vanitha  
HOD/MCA, E.G.S.P.E.C.

##### COORDINATORS:

Dr. A. S. Anakath  
Department of MCA

Prof. M. Rajakumaran  
Department of CSE

Venue: A/C Seminar Hall, PG Block

##### IMPORTANT DATES

Submission of Application : 10/12/2018  
Intimation of Selection : 12/12/2018  
Confirmation by Participants : 13/12/2018

### REGISTRATION FORM

Name : **V. Ezhilarasu**  
Designation : **Assistant Professor - IT**  
Qualification : **M.E**  
E-mail : **Satezhillo@gmail.com**  
Mobile no. : **805664995**  
DOB and Age : **11-1-1989**  
Institution address : **A.V.C. College of Engg.**  
Communication address : **Mennampalay, Majiladuturai**

I declare that the details furnished above are true to the best of my knowledge and belief and agreed to abide by the rules and regulations governing the conduct of faculty development training program sponsored by Centre for Faculty Development Anna University, Chennai.

Signature of Applicant

#### SPONSORSHIP CERTIFICATE

Certified that ~~Dr.~~ **Mrs.**

**V. Ezhilarasu, DP - IT**

is a bonafide faculty member of our Engineering College. He /She is identified to teach the subject "**AI/ITES/IT**". He/She is sponsored to attend this FDTP programme from 15<sup>th</sup> Dec -28<sup>th</sup> Dec 2018.

**Dr. S. RAMABALAN, M.E., Ph.D.,**  
PRINCIPAL  
Signifying CS No. ~~of the Department~~

**E.G.S. Pillay Engineering College**  
Pillaythi, Nagore - 611 002.  
DEPARTMENT OF IT  
Nagapattinam



REGISTRATION FORM

Name : C. Palanichamy  
Designation : AP/CSE  
Qualification : ME (PHD)  
E-mail : Palanichamy1989@gmail.com.  
Mobile no. : 7530049067  
DOB and Age : 27-04-1989  
Institution address : Chenturam College of Eng & Tech.  
Communication address : 3/95, 3<sup>rd</sup> st, Pontamil Nagal  
Near Sai Baba Temple, Puthukottai

I declare that I am willing to attend this FDTP programme on CS6601- Distributed System from 15th Dec - 28th Dec 2018.

I declare that the details furnished above are true to the best of my knowledge and belief and agreed to abide by the rules and regulations governing the conduct of faculty development training program sponsored by Centre for Faculty Development Anna University, Chennai.

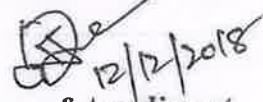
  
Signature of Applicant

Date : 12/12/2018

Place: Puthukottai

**ATTESTED**  
  
Dr. S. RAMABALAN, M.E., Ph.D.,  
PRINCIPAL  
E.G.S. Pillay Engineering College,  
Thethi, Nagore - 611 002,  
Nagapattinam (Dt) Tamil Nadu.



REGISTRATION FORM

Name : M. Kirithi Kadevi  
Designation : AP/CSE  
Qualification : M.E  
E-mail : kirithikam1984@gmail.com  
Mobile no. : 9943910708  
DOB and Age : 13-07-1984  
Institution address : Chenduran College of Engg & Technology  
Communication address : 14/10 Ishwariya Illam,  
Middle Street, Mailam  
Pudukottai Dt

I declare that I am willing to attend this FDTP programme on CS6601- Distributed System from 15th Dec - 28th Dec 2018.

I declare that the details furnished above are true to the best of my knowledge and belief and agreed to abide by the rules and regulations governing the conduct of faculty development training program sponsored by Centre for Faculty Development Anna University, Chennai.

  
Signature of Applicant

Date : 12-12-18

Place: Pudukottai.

**ATTESTED**  
  
Dr. S. RAMABALAN, M.E., Ph.D  
PRINCIPAL  
E.G.S. Pillay Engineering College,  
Thethi, Nagore - 611 002  
Nagapattinam (Dt) Tanj.

REGISTRATION FORM

Name : V.T.A. ANITHA  
Designation : AP/CSE  
Qualification : M.E  
E-mail : Vtaanime@gmail.com  
Mobile no. : 7373067064  
DOB and Age : 23.05.1984  
Institution address : Chendurian college of Eng & Tech  
Communication address : No : 14/114  
Sannathi Street  
Pudukottai

I declare that I am willing to attend this FDTP programme on CS6601- Distributed System from 15th Dec - 28th Dec 2018.

I declare that the details furnished above are true to the best of my knowledge and belief and agreed to abide by the rules and regulations governing the conduct of faculty development training program sponsored by Centre for Faculty Development Anna University, Chennai.

  
Signature of Applicant

Date : 13/12/2018

Place: Pudukottai

**ATTESTED**  
  
**Dr. S. RAMABALAN, M.E., Ph.D.**  
PRINCIPAL  
E.G.S. Pillay Engineering College,  
Thethi, Nagore - 611 002.  
Nagapattinam (Dt) Tamil Nadu.

## REGISTRATION FORM

Name : D. INFANTA JERSY  
Designation : AP  
Qualification : M.E  
E-mail : dd.infantadavid@gmail.com  
Mobile no. : 9629203811  
DOB and Age : 14.10.1993 & 25  
Institution address : SINCET, Nagai.  
Communication address : 49, Ariya rattu south street,  
Velankanni - 611111  
Nagai (Dt).

I declare that the details furnished above are true to the best of my knowledge and belief and agreed to abide by the rules and regulations governing the conduct of faculty development training program sponsored by Centre for Faculty Development Anna University, Chennai.

  
Signature of Applicant

## SPONSORSHIP CERTIFICATE

Certified that Dr. /Prof. /Mr. /Mrs.

Ms. D. INFANTA JERSY

is a bonafide faculty member of our Engineering College. He /She is identified to teach the subject "Distributed System". He/She is sponsored to attend this FDTP programme from 15<sup>th</sup> Dec -28<sup>th</sup> Dec 2018.

  
Signature & Seal of the Principal

**PRINCIPAL**

Sir Issac Newton College  
of Engineering and Technology  
Pappakovil, Nagapattinam - 611 102.

  
Date : 18.12.18  
Place: Nagapattinam.

**ATTESTED**  
  
**Dr. S. RAMABALAN, M.E., Ph.D.**  
**PRINCIPAL**

Engineering College  
E-611 002  
Tamil Nadu.

## REGISTRATION FORM

Name = M. Anitha  
Designation = AP  
Qualification = M.E  
E-mail = anithamurugan91@gmail.com  
Mobile no. = 8248619276  
DOB and Age = 05.06.1991, 28  
Institution address = SINCET - Nagai  
Communication address = Vadakkupanaigar, Thirukkupanaigar (po)  
Valivalam (vi), Thirukkavalar (te)

I declare that the details furnished above are true to the best of my knowledge and belief and agreed to abide by the rules and regulations governing the conduct of faculty development training program sponsored by Centre for Faculty Development Anna University, Chennai.

  
Signature of Applicant

## SPONSORSHIP CERTIFICATE

Certified that Dr. /Prof. /Mr. /Mrs.

Ms. M. ANITHA

is a bonafide faculty member of our Engineering College. He /She is identified to teach the subject "Distributed System". He/She is sponsored to attend this FDTP programme from 15<sup>th</sup> Dec -28<sup>th</sup> Dec 2018.

  
Signature & Seal of the Principal

PRINCIPAL

Sir Issac Newton College  
of Engineering and Technology  
Pappakudi, Nagapattinam - 611 102.

Date: 18/12/18

Place: Nagapattinam.

  
Dr. S. RAMABALAN, M.E., Ph.D.,  
PRINCIPAL

E.G.S. Pillay Engineering College,  
Thethi, Nagore - 611 002.  
Nagapattinam (Dt) Tamil Nadu.



**TWO WEEKS FDTP  
ON**

**CS6601 – Distributed System  
15-12-2018 to 28-12-2018**

**REGISTRATION FORM**

**COORDINATORS**

**Dr. A. S. ANAKATH**

**Mr. M. RAJAKUMARAN**



Approved by

**Anna University, Chennai -25**

Organized by



**ATTESTED**

**Dr. M. RAMABALAN, M.E., PH.D.,  
PRINCIPAL**

**DEPARTMENT OF CSE & MCA Engineering College,  
E.G.S. Pillay Engineering College, Nagore - 611 002.  
(An Autonomous Institution) Nagapattinam (Dt) Tamil Nadu**

Affiliated to Anna University, Chennai  
Nagapattinam – 611 002.  
www.egspec.org.

**ORGANIZING COMMITTEE**

**CHIEF PATRON:**

**Dr. M. K. Surappa**  
Vice-Chancellor  
Anna University  
Chennai

**PATRON:**

**Dr. J. Kumar**  
Registrar  
Anna University  
Chennai

**CHAIR:**

**Dr.D. Sridharan**  
Director, CFD

**Dr. I. Arul Aram**  
Addl. Director, CFD

**CO CHAIRS:**

**Shri. S. Paramesvaran**  
Secretary, E.G.S.P.GOI.

**Dr. S. Ramabalan**  
Principal, E.G.S.P.E.C.

**Dr. M. Chinnadurai**  
HOD/CSE, E.G.S.P.E.C.

**Prof. J. Vanitha**  
HOD/MCA, E.G.S.P.E.C.

**COORDINATORS:**

**Dr. A. S. Anakath**  
Department of MCA

**Prof. M. Rajakumaran**  
Department of CSE

**Venue: A/C Seminar Hall, PG Block**

**IMPORTANT DATES**

Submission of Application : 10/12/2018  
Intimation of Selection : 12/12/2018  
Confirmation by Participants : 13/12/2018

**REGISTRATION FORM**

Name : **K. Manikanda Kumaran**  
Designation : **AP**  
Qualification : **M.E (Ph.D)**  
E-mail : **mail2kmtk@gmail.com**  
Mobile no. : **7373067034**  
DOB and Age : **15/11/1988 K 30**  
Institution address : **E.G.S. Pillay Engg College,  
Nagapattinam.**  
Communication address : **AP / IT, E.G.S.P.E.C.  
Nagapattinam.**

I declare that the details furnished above are true to the best of my knowledge and belief and agreed to abide by the rules and regulations governing the conduct of faculty development training program sponsored by Centre for Faculty Development Anna University, Chennai.

**Signature of Applicant**

*Manikanda Kumaran*

**SPONSORSHIP CERTIFICATE**

Certified that Dr. /Prof. /Mr. /Mrs.

**K. Manikanda Kumaran**

is a bonafide faculty member of our Engineering College. He /She is identified to teach the subject "Distributed System". He/She is sponsored to attend this FDTP programme from 15<sup>th</sup> Dec -28<sup>th</sup>



**Signature & Seal of the Principal**

**PRINCIPAL**

**E.G.S. Pillay Engineering College,  
Nagapattinam.**

## REGISTRATION FORM

Name : A. Hema.  
Designation : Assistant Professor  
Qualification : MCA, M.Phil  
E-mail : hema@egspee.org  
Mobile no. : 7595690251  
DOB and Age : 10.12.1976, 42  
Institution address : AP/MCA, Egspee, Nagapattinam  
Communication address : No. 8, Teachers street, Thethi, Nagapattinam

I declare that the details furnished above are true to the best of my knowledge and belief and agreed to abide by the rules and regulations governing the conduct of faculty development training program sponsored by Centre for Faculty Development Anna University, Chennai.

  
Signature of Applicant

## SPONSORSHIP CERTIFICATE

Certified that Dr. /Prof. /Mr./Mrs. A. Hema  
is a bonafide faculty member of our Engineering College. He /She is identified to teach the subject "Distributed System". He/She is sponsored to attend this FDTP programme from 15<sup>th</sup> Dec -28<sup>th</sup> Dec 2018.

Date : 10.12.2018  
Place : Nagapattinam



  
Signature & Seal of the Principal

**PRINCIPAL**  
E.G.S. Pillay Engineering College,  
Nagapattinam.

**ATTESTED**

  
Dr. S. RAMABALAN, M.E., Ph.D.,  
PRINCIPAL  
E.G.S. Pillay Engineering College,  
Thethi, Nagore - 611 002.  
Nagapattinam (Dt) Tamil Nadu.

## REGISTRATION FORM

Name : N. Dharthy  
Designation : AP  
Qualification : MCA, (Ph.D)  
E-mail : n.dharthy@egspec.org  
Mobile no. : 9791878714  
DOB and Age : 27.10.1990 / 28  
Institution address : E.G.S.P.E.C, Nagai - 611002  
Communication address : E.G.S.P.E.C, Nagai - 611002

I declare that the details furnished above are true to the best of my knowledge and belief and agreed to abide by the rules and regulations governing the conduct of faculty development training program sponsored by Centre for Faculty Development Anna University, Chennai.

  
Signature of Applicant

## SPONSORSHIP CERTIFICATE

Certified that Dr. /Prof. /Mr./Mrs. N. Dharthy  
is a bonafide faculty member of our Engineering College. He /She is identified to teach the subject "Distributed System". He/She is sponsored to attend this FDTP programme from 15<sup>th</sup> Dec -28<sup>th</sup> Dec 2018.

Date : 13.12.2018  
Place : Nagai

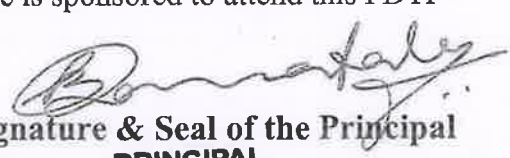

  
Signature & Seal of the Principal  
**PRINCIPAL**  
E.G.S. Pillay Engineering College,  
Nagapattinam.

**ATTESTED**  
  
Dr. S. RAMABALAN, M.E., Ph.D.  
PRINCIPAL  
E.G.S. Pillay Engineering College,  
Thethi, Nagore - 611 002.  
Nagapattinam (Dt) Tamil Nadu



**TWO WEEKS FDTP  
ON**

**CS6601 – Distributed System  
15-12-2018 to 28-12-2018**

**REGISTRATION FORM**

**COORDINATORS**

**Dr. A. S. ANAKATH  
Mr. M. RAJAKUMARAN**



**Approved by  
Anna University, Chennai -25  
Organized by**



**ATTESTED**  
DEPARTMENT OF CSE & MCA  
E.G.S. Pillay Engineering College  
(An Autonomous Institution)  
**Dr. S. RAMABALAN, M.E., Ph.D.,**  
PRINCIPAL  
Affiliated to Anna University, Chennai  
Nagapattinam – 611 002  
www.egspg.org  
Nagapattinam (Dt) Tamil Nadu.

**ORGANIZING COMMITTEE**

**CHIEF PATRON:**

**Dr. M. K. Surappa**  
Vice-Chancellor  
Anna University  
Chennai

**PATRON:**

**Dr. J. Kumar**  
Registrar  
Anna University  
Chennai

**CHAIR:**

**Dr.D. Sridharan**  
Director, CFD

**Dr. I. Arul Aram**

**Addl. Director, CFD**

**CO CHAIRS:**

**Shri. S. Paramesvaran**  
Secretary, E.G.S.P GOI.

**Dr. S. Ramabalan**  
Principal, E.G.S.P.E.C.

**Dr. M. Chinnadurai**  
HOD/CSE, E.G.S.P.E.C.

**Prof. J. Vanitha**  
HOD/MCA, E.G.S.P.E.C.

**COORDINATORS:**

**Dr. A. S. Anakath**  
Department of MCA

**Prof. M. Rajakumar**  
Department of CSE

**Venue: A/C Seminar Hall, PG Block**

**IMPORTANT DATES**

Submission of Application : 10/12/2018  
Intimation of Selection : 12/12/2018  
Confirmation by Participants : 13/12/2018

**REGISTRATION FORM**

Name : **GOKILA . R.G**  
Designation : **Asst. Professor**  
Qualification : **ME (SE)**  
E-mail : **rgokila1702@gmail.com**  
Mobile no. : **9844946296**  
DOB and Age : **17.02.1989 , 29**  
Institution address : **E. G. S. Pillay Engg. College,  
Nagai**  
Communication address :

I declare that the details furnished above are true to the best of my knowledge and belief and agreed to abide by the rules and regulations governing the conduct of faculty development training program sponsored by Centre for Faculty Development Anna University, Chennai.

**R. G. GOKILA**  
Signature of Applicant

**SPONSORSHIP CERTIFICATE**

Certified that Dr. /Prof. /Mr. /Mts.

**R. G. GOKILA AP/IT**

is a bonafide faculty member of our Engineering College. He /She is identified to teach the subject "Distributed System". He/She is sponsored to and this FDTP programme from 15<sup>th</sup> Dec -28<sup>th</sup> Dec 2018.



**R. G. GOKILA**  
Signature & Seal of the Principal

**PRINCIPAL**  
**E.G.S. Pillay Engineering College,  
Nagapattinam.**

Date :  
Place :



## TWO WEEKS FDTP

ON

## CS6601 – Distributed System

15-12-2018 to 28-12-2018

## REGISTRATION FORM

### COORDINATORS

**Dr. A. S. ANAKATH**

**Mr. M. RAJAKUMARAN**



Approved by

**Anna University, Chennai -25**

Organized by



**DEPARTMENT OF CSE & MCA**  
E.G.S. Pillay Engineering College

(An Autonomous Institution)  
**APPROVED RAJAKUMARAN, M.E. Ph.D.**  
Nagapattinam - 611 002

**E.G.S. Pillay Engineering College,**  
Thethi, Nagore - 611 002.

Nagapattinam - (Dt.) Tamil N.

### ORGANIZING COMMITTEE

#### CHIEF PATRON:

**Dr. M. K. Surappa**  
Vice-Chancellor  
Anna University  
Chennai

#### PATRON:

**Dr. J. Kumar**  
Registrar  
Anna University  
Chennai

#### CHAIR:

**Dr. D. Sridharan**  
Director, CFD

**Dr. I. Arul Aram**  
Addl. Director, CFD

#### CO CHAIRS:

**Shri. S. Paramesvaran**  
Secretary, E.G.S.P GOI.

**Dr. S. Ramabalan**  
Principal, E.G.S.P.E.C.

**Dr. M. Chinnadurai**  
HOD/CSE, E.G.S.P.E.C.

**Prof. J. Vanitha**  
HOD/MCA, E.G.S.P.E.C.

#### COORDINATORS:

**Dr. A. S. Anakath**  
Department of MCA

**Prof. M. Rajakumaran**  
Department of CSE

Venue: A/C Seminar Hall, PG Block

#### IMPORTANT DATES

Submission of Application : 10/12/2018  
Intimation of Selection : 12/12/2018  
Confirmation by Participants : 13/12/2018

## REGISTRATION FORM

Name : **S. Palani Murugan**  
Designation : **AP/CSE**  
Qualification : **M.E., (Ph.D)**  
E-mail : **Suyambhu@gmail.com**  
Mobile no. : **9790486733**  
DOB and Age : **10.07.1988 & 30**  
Institution address : **E.G.S Pillay Engineering College**  
Communication address : **11**

I declare that the details furnished above are true to the best of my knowledge and belief and agreed to abide by the rules and regulations governing the conduct of faculty development training program sponsored by Centre for Faculty Development Anna University, Chennai.

Signature of Applicant

## SPONSORSHIP CERTIFICATE

Certified that Dr. /Prof. /Mr. /Mrs.

**S. Palani Murugan**

is a bonafide faculty member of our Engineering College. He /She is identified to teach the subject "Distributed System". He/She is sponsored to attend this FDTP programme from 15<sup>th</sup> Dec-28<sup>th</sup> Dec-2018.



Signature & Seal of the Principal

**PRINCIPAL**

**E.G.S. Pillay Engineering College,**

Nagapattinam

**TWO WEEKS FDTP  
ON  
CS6601 – Distributed System**

**15-12-2018 to 28-12-2018**

**REGISTRATION FORM**

**COORDINATORS**

**Dr. A. S. ANAKATH  
Mr. M. RAJAKUMARAN**



Approved by  
**Anna University, Chennai -25**  
Organized by



**DEPARTMENT OF CSE & MCA**  
**E.G.S. Pillay Engineering College**  
(An Autonomous Institution)  
Affiliated to Anna University, Chennai  
Nagapattinam – 611 002.  
[www.egspec.org](http://www.egspec.org)

**ORGANIZING COMMITTEE**

**CHIEF PATRON:**

**Dr. M. K. Surappa**  
Vice-Chancellor  
Anna University  
Chennai

**PATRON:**

**Dr. J. Kumar**  
Registrar  
Anna University  
Chennai

**CHAIR:**

**Dr. D. Sridharan**  
Director, CFD

**Dr. I. Arul Aram**  
Addl. Director, CFD

**CO CHAIRS:**

**Shri. S. Paramesvaran**  
Secretary, E.G.S.P GOI.

**Dr. S. Ramabalan**  
Principal, E.G.S.P.E.C.

**Dr. M. Chinnadurai**  
HOD/CSE, E.G.S.P.E.C.

**Prof. J. Vanitha**  
HOD/MCA, E.G.S.P.E.C.

**COORDINATORS:**

**Dr. A. S. Anakath**  
Department of MCA

**Prof. M. Rajakumaran**  
Department of CSE

**Venue: A/C Seminar Hall, PG Block**

**IMPORTANT DATES**

Submission of Application : 10/12/2018  
Intimation of Selection : 12/12/2018  
Confirmation by Participants : 13/12/2018

**REGISTRATION FORM**

Name : **G. Arul Selvan**  
Designation : **Asst. Professor**  
Qualification : **M.E**  
E-mail : **arulselvan@gmail.com**  
Mobile no. : **8870641821**  
DOB and Age : **11/08/1985 33**  
Institution address : **Dept. of CSE**  
Communication address : **Eas. Pillay Engg. College**

I declare that the details furnished above are true to the best of my knowledge and belief and agreed to abide by the rules and regulations governing the conduct of faculty development training program sponsored by Centre for Faculty Development Anna University, Chennai.

Signature of Applicant

**SPONSORSHIP CERTIFICATE**

Certified that **Dr. /Prof. /Mr. /Mrs.**

**G. ARUL SELVAN**

is a bonafide faculty member of our Engineering College. He /She is identified to teach the subject "Distributed System". He/She is sponsored to attend this FDTP programme from 15<sup>th</sup> Dec -28<sup>th</sup> Dec 2018.

Signature & Seal of the Principal

Date : 10/12/18

Place: **Nagapattinam**  
**E.G.S. Pillay Engineering College,**  
PRINCIPAL

# TWO WEEKS FDTP ON

## CS6601 – Distributed System 15-12-2018 to 28-12-2018

### REGISTRATION FORM

#### COORDINATORS

**Dr. A. S. ANAKATH**

**Mr. M. RAJAKUMARAN**



Approved by

**Anna University, Chennai -25**

Organized by



**DEPARTMENT OF MCA**  
**PRINCIPAL**  
E.G.S. Pillay Engineering College  
Chithambalur, Nagore - 611 002  
Nagapattinam (Dt) Tamil Nadu

### ORGANIZING COMMITTEE

#### CHIEF PATRON:

**Dr. M. K. Surappa**  
Vice-Chancellor  
Anna University  
Chennai

#### PATRON:

**Dr. J. Kumar**  
Registrar  
Anna University  
Chennai

#### CHAIR:

**Dr. D. Sridharan**  
Director, CFD

**Dr. I. Arul Aram**  
Addl. Director, CFD

#### CO CHAIRS:

**Shri. S. Paramesvaran**  
Secretary, E.G.S.P GOI.

**Dr. S. Ramabalan**  
Principal, E.G.S.P.E.C.

**Dr. M. Chinnadurai**  
HOD/CSE, E.G.S.P.E.C.

**Prof. J. Vanitha**  
HOD/MCA, E.G.S.P.E.C.

#### COORDINATORS:

**Dr. A. S. Anakath**  
Department of MCA

**Prof. M. Rajakumaran**  
Department of CSE

**Venue: A/C Seminar Hall, PG Block**

#### IMPORTANT DATES

Submission of Application: 15.12.2018  
Registration: 16.12.2018

### REGISTRATION FORM

Name : **K. BALASUBRAMANIAN**  
Designation : **ASSOCIATE PROFESSOR**  
Qualification : **M.E (Ph.D),**  
E-mail : **bala@egspec.org**  
Mobile no. : **9942666526**  
DOB and Age : **02.11.1983 & 35**  
Institution address : **E.G.S.PILLAY ENGR.COLLE**  
Communication address : **NAGAPATTINAM**

I declare that the details furnished above are true to the best of my knowledge and belief and agreed to abide by the rules and regulations governing the conduct of faculty development training program sponsored by Centre for Faculty Development Anna University, Chennai.

Signature of Applicant

### SPONSORSHIP CERTIFICATE

Certified that Dr. /Prof. /Mr. /Mrs

**K. BALASUBRAMANIAN**

is a bonafide faculty member of our Engineering College. He /She is identified to teach the subject "Distributed System". He/She is sponsored to attend this FDTP programme from 15<sup>th</sup> Dec-2018

Dec 2018.



**PRINCIPAL**  
**E.G.S. Pillay Engineering College,**



## REGISTRATION FORM

Name : S. Selvaganapathy. S  
Designation : Ap  
Qualification : MCA., (Ph.D)  
E-mail : Selvaganapathy @ egsee.org  
Mobile no. : 984270327  
DOB and Age : 20/06/1984/36  
Institution address : E.G.S.P.E.C, Nagai - 611002  
Communication address : E.G.S.P.E.C, Nagai - 611002

I declare that the details furnished above are true to the best of my knowledge and belief and agreed to abide by the rules and regulations governing the conduct of faculty development training program sponsored by Centre for Faculty Development Anna University, Chennai.

  
Signature of Applicant

## SPONSORSHIP CERTIFICATE

Certified that Dr./Prof./Mr./Mrs. S. Selvaganapathy  
is a bonafide faculty member of our Engineering College. He/She is identified to teach the subject "Distributed System". He/She is sponsored to attend this FDTP programme from 15<sup>th</sup> Dec -28<sup>th</sup> Dec 2018.

Date : 12/12/2018  
Place: Nagai



  
Signature & Seal of the Principal

**PRINCIPAL**  
**E.G.S. Pillay Engineering College,**  
**Nagapattinam.**

**ATTESTED**

  
**Dr. S. RAMABALAN, M.E., Ph.D.,**  
**PRINCIPAL**  
**E.G.S. Pillay Engineering College,**  
**Thathi Nagai - 611002**



## REGISTRATION FORM

Name : P. ARUNKUMAR  
Designation : ASSISTANT PROFESSOR  
Qualification : MCA  
E-mail : parunkumar@egspec.org  
Mobile no. : 9003131147  
DOB and Age : 23-12-1982 & 36 Years  
Institution address : E.G.S PILLAY ENGINEERING COLLEGE  
NAGAPATTINAM  
Communication address : 603, BHARATHIYAR ROAD,  
THALAIHERU, KARAIKAL.

I declare that the details furnished above are true to the best of my knowledge and belief and agreed to abide by the rules and regulations governing the conduct of faculty development training program sponsored by Centre for Faculty Development Anna University, Chennai.

*P. Arunkumar*  
Signature of Applicant

## SPONSORSHIP CERTIFICATE

Certified that Dr. /Prof. /Mr./Mrs. P. ARUNKUMAR  
is a bonafide faculty member of our Engineering College. He /She is identified to teach the subject "Distributed System". He/She is sponsored to attend this FDTP programme from 15<sup>th</sup> Dec -28<sup>th</sup> Dec 2018.

*[Signature]*  
Signature & Seal of the Principal

Date : 11.12.2018  
Place: NAGAPATTINAM

**PRINCIPAL**  
**E.G.S. Pillay Engineering College,**  
**Nagapattinam.**

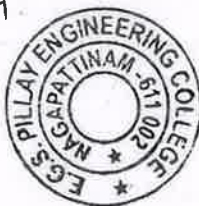

ATTESTED

*[Signature]*  
**Dr. S. RAMABALAN, M.E., Ph.D.,**  
**PRINCIPAL**

**E.G.S. Pillay Engineering College,**  
**Thethi, Nagore - 611 002.**  
**Nagapattinam (Dt) Tamil Nadu.**

## REGISTRATION FORM

Name : J. Vanitha  
Designation : Associate Professor  
Qualification : MCA, M.Phil., (Ph.D)  
E-mail : Vanitha@egpc.02  
Mobile no. : 9791878714  
DOB and Age : 4.11.1977 / 41  
Institution address : E.G.S.P.E.C, Nagai - 611002  
Communication address : E.G.S.P.E.C, Nagai - 611002

I declare that the details furnished above are true to the best of my knowledge and belief and agreed to abide by the rules and regulations governing the conduct of faculty development training program sponsored by Centre for Faculty Development Anna University, Chennai.

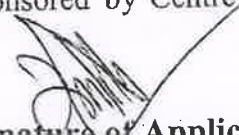
  
Signature of Applicant

## SPONSORSHIP CERTIFICATE

Certified that Dr. /Prof. /Mr./Mrs. J. Vanitha  
is a bonafide faculty member of our Engineering College. He /She is identified to teach the subject "Distributed System". He/She is sponsored to attend this FDTP programme from 15<sup>th</sup> Dec -28<sup>th</sup> Dec 2018.

Date : 12.12.2018  
Place : Nagai



  
Signature & Seal of the Principal

**PRINCIPAL**  
**E.G.S. Pillay Engineering College,**  
**Nagapattinam.**

**ATTESTED**

  
**Dr. S. RAMABALAN, M.E., Ph.D.,**  
**PRINCIPAL**  
**E.G.S. Pillay Engineering College,**  
**Thethi, Nagore - 611 002.**  
**Nagapattinam (Dt) Tamil Nadu**

## REGISTRATION FORM

Name : C. Mallika  
Designation : Assoc. Prof  
Qualification : MCA., MBA., M.Phil  
E-mail : mallika@egepee.org  
Mobile no. : 9787650176  
DOB and Age : 15.06.1977  
Institution address : E.G.S. Pillay Engineering College  
Communication address : E.G.S. Pillay Engineering College, Nagapattinam.

I declare that the details furnished above are true to the best of my knowledge and belief and agreed to abide by the rules and regulations governing the conduct of faculty development training program sponsored by Centre for Faculty Development Anna University, Chennai.

*C. Mallika*  
Signature of Applicant

## SPONSORSHIP CERTIFICATE

Certified that Dr./Prof./Mr./Mrs. C. Mallika  
is a bonafide faculty member of our Engineering College. He/She is identified to teach the subject "Distributed System". He/She is sponsored to attend this FDTP programme from 15<sup>th</sup> Dec -28<sup>th</sup> Dec 2018.

*[Signature]*  
Signature & Seal of the Principal

PRINCIPAL  
E.G.S. Pillay Engineering College,  
Nagapattinam.

Date : 12-12-18  
Place: Nagapattinam



ATTESTED

*[Signature]*  
Dr. S. RAMABALAN, M.E., Ph.D.,  
PRINCIPAL  
E.G.S. Pillay Engineering College,  
Thethi, Nagore - 611 002.  
Nagapattinam (Dr), Tamil Nadu.









**E.G.S. PILLAY ENGINEERING COLLEGE**  
 (An Autonomous Institution, Affiliated to Anna University, Chennai)  
 Nagore Post, Nagapattinam - 611 002, Tamilnadu.  
 DEPARTMENT OF CSE & MCA



**FACULTY DEVELOPMENT TRAINING PROGRAMME ON CS6601 - DISTRIBUTED SYSTEM**

Approved by Center for Faculty Development  
 [15/12/2018 - 28/12/2018]

**ATTENDANCE**

| S.NO. | NAME OF THE PARTICIPANT | DESG.               | NAME OF THE COLLEGE                            | SIGNATURE |     |       |     |        |     |        |     |        |     |        |     |        |     |     |     |     |     |     |     |     |     |     |     |     |     |     |  |
|-------|-------------------------|---------------------|--|-----------|-----|-------|-----|--------|-----|--------|-----|--------|-----|--------|-----|--------|-----|-----|-----|-----|-----|-----|-----|-----|-----|-----|-----|-----|-----|-----|--|
|       |                         |                     |  | DAY 8     |     | DAY 9 |     | DAY 10 |     | DAY 11 |     | DAY 12 |     | DAY 13 |     | DAY 14 |     |     |     |     |     |     |     |     |     |     |     |     |     |     |  |
|       |                         |                     |  | FN        | AN  | FN    | AN  | FN     | AN  | FN     | AN  | FN     | AN  | FN     | AN  | FN     | AN  | FN  | AN  | FN  | AN  | FN  | AN  | FN  | AN  | FN  | AN  | FN  | AN  |     |  |
| 1.    | M.G.Kavitha             | Assistant Professor | University College of Engineering Pattukkottai | Mud       | Mud | Mud   | Mud | Mud    | Mud | Mud    | Mud | Mud    | Mud | Mud    | Mud | Mud    | Mud | Mud | Mud | Mud | Mud | Mud | Mud | Mud | Mud | Mud | Mud | Mud | Mud | Mud |  |
| 2.    | B.Rajesh                | Assistant Professor | University College of Engineering Pattukkottai | PL        | PL  | PL    | PL  | PL     | PL  | PL     | PL  | PL     | PL  | PL     | PL  | PL     | PL  | PL  | PL  | PL  | PL  | PL  | PL  | PL  | PL  | PL  | PL  | PL  | PL  | PL  |  |
| 3.    | S.Senthilkumar          | Assistant Professor | University College of Engineering Pattukkottai | A         | A   | A     | A   | A      | A   | A      | A   | A      | A   | A      | A   | A      | A   | A   | A   | A   | A   | A   | A   | A   | A   | A   | A   | A   | A   | A   |  |
| 4.    | K.Preethi               | Assistant Professor | University College of Engineering Pattukkottai | PL        | PL  | PL    | PL  | PL     | PL  | PL     | PL  | PL     | PL  | PL     | PL  | PL     | PL  | PL  | PL  | PL  | PL  | PL  | PL  | PL  | PL  | PL  | PL  | PL  | PL  | PL  |  |
| 5.    | N.Kavitha               | Assistant Professor | University College of Engineering Pattukkottai | PL        | PL  | PL    | PL  | PL     | PL  | PL     | PL  | PL     | PL  | PL     | PL  | PL     | PL  | PL  | PL  | PL  | PL  | PL  | PL  | PL  | PL  | PL  | PL  | PL  | PL  | PL  |  |
| 6.    | E.Saranya               | Assistant Professor | Sir Issac Newton College of Engg. and Tech.    | PL        | PL  | PL    | PL  | PL     | PL  | PL     | PL  | PL     | PL  | PL     | PL  | PL     | PL  | PL  | PL  | PL  | PL  | PL  | PL  | PL  | PL  | PL  | PL  | PL  | PL  | PL  |  |
| 7.    | A.Indira Devi           | Assistant Professor | Sir Issac Newton College of Engg. and Tech.    | PL        | PL  | PL    | PL  | PL     | PL  | PL     | PL  | PL     | PL  | PL     | PL  | PL     | PL  | PL  | PL  | PL  | PL  | PL  | PL  | PL  | PL  | PL  | PL  | PL  | PL  | PL  |  |
| 8.    | G.Saranya               | Assistant Professor | Sir Issac Newton College of Engg. and Tech.    | PL        | PL  | PL    | PL  | PL     | PL  | PL     | PL  | PL     | PL  | PL     | PL  | PL     | PL  | PL  | PL  | PL  | PL  | PL  | PL  | PL  | PL  | PL  | PL  | PL  | PL  | PL  |  |
| 9.    | M.Mohamed Faisal        | Assistant Professor | S.R.V Engineering College                      | PL        | PL  | PL    | PL  | PL     | PL  | PL     | PL  | PL     | PL  | PL     | PL  | PL     | PL  | PL  | PL  | PL  | PL  | PL  | PL  | PL  | PL  | PL  | PL  | PL  | PL  | PL  |  |
| 10.   | M.Vengateshwaran        | Assistant Professor | Arasu Engineering College                      | PL        | PL  | PL    | PL  | PL     | PL  | PL     | PL  | PL     | PL  | PL     | PL  | PL     | PL  | PL  | PL  | PL  | PL  | PL  | PL  | PL  | PL  | PL  | PL  | PL  | PL  | PL  |  |
| 11.   | V.Sathya                | Assistant Professor | A.V.C. College of Engineering                  | PL        | PL  | PL    | PL  | PL     | PL  | PL     | PL  | PL     | PL  | PL     | PL  | PL     | PL  | PL  | PL  | PL  | PL  | PL  | PL  | PL  | PL  | PL  | PL  | PL  | PL  | PL  |  |
| 12.   | B.N.Karthik             | Assistant Professor | A.V.C. College of Engineering                  | PL        | PL  | PL    | PL  | PL     | PL  | PL     | PL  | PL     | PL  | PL     | PL  | PL     | PL  | PL  | PL  | PL  | PL  | PL  | PL  | PL  | PL  | PL  | PL  | PL  | PL  | PL  |  |

**ATTESTED**

  
**Dr. S. RAMA TALAN, M.E., Ph.D.,**  
 PRINCIPAL

**E.G.S. Pillay Engineering College,**  
 Thethi Nagore - 611 002.  
 Nagapattinam (Dt) Tamil Nadu.

A.S.A. 28/12/18  
 CO-ORDINATOR  
 FDTP on CS6601 - DISTRIBUTED SYSTEM  
 EGSPEC





**E.G.S. PILLAY ENGINEERING COLLEGE**  
 (An Autonomous Institution, Affiliated to Anna University, Chennai)  
 Nagore Post, Nagapattinam - 611 002, Tamilnadu.



**FACULTY DEVELOPMENT TRAINING PROGRAMME ON CS6601 - DISTRIBUTED SYSTEM**

DEPARTMENT OF CSE & MCA  
 Approved by Center for Faculty Development  
 [15/12/2018 - 28/12/2018]

**ATTENDANCE**

| S.NO. | NAME OF THE PARTICIPANT | DESG.               | NAME OF THE COLLEGE                         | SIGNATURE   |             |             |             |             |             |             |             |             |             |             |             |             |             |
|-------|-------------------------|---------------------|---|-------------|-------------|-------------|-------------|-------------|-------------|-------------|-------------|-------------|-------------|-------------|-------------|-------------|-------------|
|       |                         |                     |   | DAY 1       |             | DAY 2       |             | DAY 3       |             | DAY 4       |             | DAY 5       |             | DAY 6       |             | DAY 7       |             |
|       |                         |                     |   | FN          | AN          | FN          | AN          | FN          | AN          | FN          | AN          | FN          | AN          | FN          | AN          | FN          | AN          |
| 13.   | V.Ezhilarasi            | Assistant Professor | A.V.C. College of Engineering               | [Signature] | [Signature] | [Signature] | [Signature] | [Signature] | [Signature] | [Signature] | [Signature] | [Signature] | [Signature] | [Signature] | [Signature] | [Signature] | [Signature] |
| 14.   | C.Palamichamy           | Assistant Professor | Chenduran College of Engg. and Tech.        | [Signature] | [Signature] | [Signature] | [Signature] | [Signature] | [Signature] | [Signature] | [Signature] | [Signature] | [Signature] | [Signature] | [Signature] | [Signature] | [Signature] |
| 15.   | M.Kirithika Devi        | Assistant Professor | Chenduran College of Engg. and Tech.        | [Signature] | [Signature] | [Signature] | [Signature] | [Signature] | [Signature] | [Signature] | [Signature] | [Signature] | [Signature] | [Signature] | [Signature] | [Signature] | [Signature] |
| 16.   | V.T.A.Amitha            | Assistant Professor | Chenduran College of Engg. and Tech.        | [Signature] | [Signature] | [Signature] | [Signature] | [Signature] | [Signature] | [Signature] | [Signature] | [Signature] | [Signature] | [Signature] | [Signature] | [Signature] | [Signature] |
| 17.   | D.Infanta Jersey        | Assistant Professor | Sir Issac Newton College of Engg. and Tech. | [Signature] | [Signature] | [Signature] | [Signature] | [Signature] | [Signature] | [Signature] | [Signature] | [Signature] | [Signature] | [Signature] | [Signature] | [Signature] | [Signature] |
| 18.   | M.Anitha                | Assistant Professor | Sir Issac Newton College of Engg. and Tech. | [Signature] | [Signature] | [Signature] | [Signature] | [Signature] | [Signature] | [Signature] | [Signature] | [Signature] | [Signature] | [Signature] | [Signature] | [Signature] | [Signature] |
| 19.   | K. Manikanda Kumaran    | Assistant Professor | E.G.S.Pillay Engineering College            | [Signature] | [Signature] | [Signature] | [Signature] | [Signature] | [Signature] | [Signature] | [Signature] | [Signature] | [Signature] | [Signature] | [Signature] | [Signature] | [Signature] |
| 20.   | A. Hema                 | Assistant Professor | E.G.S.Pillay Engineering College            | [Signature] | [Signature] | [Signature] | [Signature] | [Signature] | [Signature] | [Signature] | [Signature] | [Signature] | [Signature] | [Signature] | [Signature] | [Signature] | [Signature] |
| 21.   | N. Ilakkiya             | Assistant Professor | E.G.S.Pillay Engineering College            | [Signature] | [Signature] | [Signature] | [Signature] | [Signature] | [Signature] | [Signature] | [Signature] | [Signature] | [Signature] | [Signature] | [Signature] | [Signature] | [Signature] |
| 22.   | R.G. Gokila             | Assistant Professor | E.G.S.Pillay Engineering College            | [Signature] | [Signature] | [Signature] | [Signature] | [Signature] | [Signature] | [Signature] | [Signature] | [Signature] | [Signature] | [Signature] | [Signature] | [Signature] | [Signature] |
| 23.   | S.Palani Murugan        | Assistant Professor | E.G.S.Pillay Engineering College            | [Signature] | [Signature] | [Signature] | [Signature] | [Signature] | [Signature] | [Signature] | [Signature] | [Signature] | [Signature] | [Signature] | [Signature] | [Signature] | [Signature] |
| 24.   | G.Arul Selvan           | Assistant Professor | E.G.S.Pillay Engineering College            | [Signature] | [Signature] | [Signature] | [Signature] | [Signature] | [Signature] | [Signature] | [Signature] | [Signature] | [Signature] | [Signature] | [Signature] | [Signature] | [Signature] |
| 25.   | K.Balasubramanian       | Assistant Professor | E.G.S.Pillay Engineering College            | [Signature] | [Signature] | [Signature] | [Signature] | [Signature] | [Signature] | [Signature] | [Signature] | [Signature] | [Signature] | [Signature] | [Signature] | [Signature] | [Signature] |

**ATTESTED**

*[Signature]*  
**Dr. S. RAMABALAN, M.E., Ph.D.,**  
 PRINCIPAL

**E.G.S. Pillay Engineering College,**  
 Thethi, Nagore - 611 002.  
 Nagapattinam (Dt) Tamil Nadu.

*[Signature]* 28/12/18  
 CO-ORDINATOR

FDTP on CS6601 - DISTRIBUTED SYSTEM  
 EGSPEC





# CENTRE FOR FACULTY DEVELOPMENT

Anna University, Chennai-600025

FACULTY DEVELOPMENT TRAINING PROGRAMME - Winter Vacation-2018

## DECLARATION FORM

Dr. / Mr. / Mrs. / Ms. M. G. Kavitha  
working as Assistant Professor/CSE in the college of University College  
of Engineering Pattukkottai  
declare that I am participating in the FDTP on Distributed Systems  
at E.G.S. Pillay Engineering College  
from 15-12-2018 to 28-12-2018

I also confirm that in the above mentioned period I am not involved in any other official work.

M. G. K. 15/12/18

Signature with date of the Participant

ATTESTED

Dr. S. RAMABALAN, M.E., Ph.D.,  
PRINCIPAL

E.G.S. Pillay Engineering College,  
Thethi, Nagore - 611 002.  
Nagapattinam (Dt) Tamil Nadu.



# CENTRE FOR FACULTY DEVELOPMENT

Anna University, Chennai-600025.

FACULTY DEVELOPMENT TRAINING PROGRAMME - Winter Vacation-2018

## DECLARATION FORM

Dr. / Mr. / Mrs. / Ms. B. RAJESH

working as Asst. Professor in the college of University College  
of Engineering, Pattukkottai

declare that I am participating in the FDTP on C.S.6601 - Distributed System

at E.G.S. Pillay Engineering College

from 15.12.2018 to 28.12.2018

I also confirm that in the above mentioned period I am not involved in any other official work.



Signature with date of the Participant

ATTESTED

  
Dr. S. RAMABALAN, M.E., Ph.D.,  
PRINCIPAL  
E.G.S. Pillay Engineering College,  
Thethi, Nagore - 611 002.  
Nagapattinam (Dt) Tamil Nadu.

CENTRE FOR FACULTY DEVELOPMENT

Anna University, Chennai-600025

FACULTY DEVELOPMENT TRAINING PROGRAMME - Winter Vacation-2018

DECLARATION FORM

Dr. / Mr. / Mrs. / Ms. S. Senthil Kumar

working as Assistant prof in the college of University

College of Engineering Palkkottai

declare that I am participating in the FDTP on CS6601 Distributed Syste

at E. G. S. Pillai Engineering College

from 15/12/18 to 28/12/2018

I also confirm that in the above mentioned period I am not involved in any other official work.

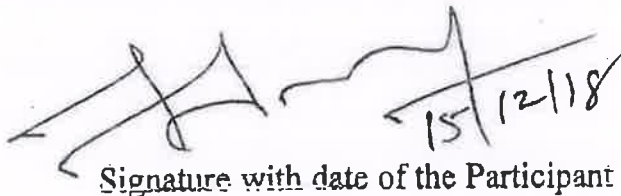
  
Signature with date of the Participant

ATTESTED  
  
Dr. S. RAMABALAN, M.E., Ph.D.,  
PRINCIPAL  
E.G.S. Pillay Engineering College,  
Thethi, Nagore - 611 002,  
Nagapattinam (Dt)-Tamil Nadu.

# CENTRE FOR FACULTY DEVELOPMENT

Anna University, Chennai-600025.

FACULTY DEVELOPMENT TRAINING PROGRAMME - Winter Vacation-2018

## DECLARATION FORM

Dr. / Mr. / Mrs. / Ms. ..... K. PREETHI .....

working as ..... AP/CSE ..... in the college of ..... UCE .....

..... University College of Engineering Pattukkottai .....

declare that I am participating in the FDTP on ..... CS6601 - Distributed Systems .....

at ..... E.S.S. Pillay Engg College, Nagapattinam .....

from ..... 15.12.2018 ..... to ..... 28.12.2018 .....

I also confirm that in the above mentioned period I am not involved in any other official work.

Signature with date of the Participant

ATTESTED

Dr. S. RAMABALAN, M.E., Ph.D.,  
PRINCIPAL

E.G.S. Pillay Engineering College,  
Thothu Nagore - 611 002.  
Nagapattinam, (Dt) Tamil Nadu.

CENTRE FOR FACULTY DEVELOPMENT  
Anna University, Chennai-600025.

FACULTY DEVELOPMENT TRAINING PROGRAMME - Winter Vacation-2018

DECLARATION FORM

✓  
Dr. / Mr. / Mrs. / Ms. ..... N. KAVITHA .....

working as AP/ Mathematics in the college of UCE -

Pattukkottai, Rajamadam

declare that I am participating in the FDTP on CS6601 - Distributed System

at E.G.S. Pillay Engg. College, Nagapatt

from 15.12.2018 to 28.12.2018

I also confirm that in the above mentioned period I am not involved in any other official work.

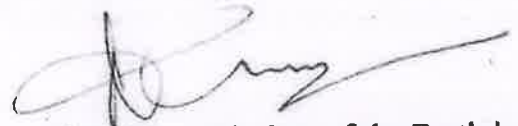

Signature with date of the Participant

ATTESTED

  
Dr. S. RAMABALAN, M.E., Ph.D.,  
PRINCIPAL

E.G.S. Pillay Engineering College,  
Thethi, Nagore - 611 002.  
Nagapattinam (Dt) Tamil Nadu.



# CENTRE FOR FACULTY DEVELOPMENT

Anna University, Chennai-600025.

FACULTY DEVELOPMENT TRAINING PROGRAMME - Winter Vacation-2018

## DECLARATION FORM

Dr. / Mr. / Mrs. / Ms. E. SARANYA

working as AP/CSE in the college of SIR ISSAC

NEWTON COLLEGE OF ENGINEERING & TECHNOLOGY, PAPPAROLI

hereby declare that I have attended the FDTP on DISTRIBUTED SYSTEMS

held at E. G. S. PILLAY ENGINEERING COLLEGE, NAGAPATTINAM

during the period from 15/12/2018 to 28/12/2018

I also confirm that in the above mentioned period I am not involved in any other official work.

E. Saranya  
28/12/18

Signature of the Participant with date

ATTESTED

Dr. S. RAMABALAN, M.E., Ph.D.,  
PRINCIPAL

E.G.S. Pillay Engineering College,  
Thethi, Nagore - 611 002.  
Nagapattinam (Dt) Tamil Nadu:-

# CENTRE FOR FACULTY DEVELOPMENT

Anna University, Chennai-600025.

**FACULTY DEVELOPMENT TRAINING PROGRAMME - Winter Vacation-2018**

## DECLARATION FORM

Dr. / Mr. / Mrs. / Ms. A. INDIRA DEVI

working as AP/CSE in the college of SIR ISAAC NEWTON  
COLLEGE OF ENGINEERING & TECHNOLOGY, PAPPARUVIL

hereby declare that I have attended the FDTP on DISTRIBUTED SYSTEMS  
held at E.G.S. PILLAY ENGINEERING COLLEGE, NAGAPATTINAM  
during the period from 15/12/2018 to 28/12/2018

I also confirm that in the above mentioned period I am not involved in any other  
official work.

A. Indira  
Signature of the Participant with date

ATTESTED

[Signature]  
Dr. S. RAMABALAN, M.E., Ph.D.,  
PRINCIPAL  
E.G.S. Pillay Engineering College,  
Thethi, Nagore - 611 002.  
Nagapattinam (Dt) Tamil Nadu.

# CENTRE FOR FACULTY DEVELOPMENT

Anna University, Chennai-600025.

**FACULTY DEVELOPMENT TRAINING PROGRAMME - Winter Vacation-2018**

## DECLARATION FORM

Dr./Mr./Mrs./Ms. G. SARANYA

working as AP - CSE in the college of Sri Isaac

Newton College Of Engineering & Technology - Pappakoil, Nagapattinam

hereby declare that I have attended the FDTP on Distributed systems

held at E.G.S Pillay Engineering College - Nagapattinam

during the period from 15-12-18 to 28-12-18

I also confirm that in the above mentioned period I am not involved in any other official work.

  
28/12/18

Signature of the Participant with date

ATTESTED

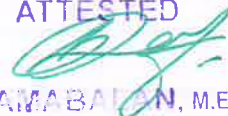

Dr. S. RAMABALAN, M.E., Ph.D.,  
PRINCIPAL

E.G.S. Pillay Engineering College,  
Thethi, Nagore - 611 002.  
Nagapattinam (Dt) Tamil Nadu.

# CENTRE FOR FACULTY DEVELOPMENT

Anna University, Chennai-600025.

FACULTY DEVELOPMENT TRAINING PROGRAMME - Winter Vacation-2018

## DECLARATION FORM

Dr./ Mr. / Mrs. / Ms. M. MOHAMED FAISAL

working as Asst. prof / CSE in the college of SEMBODAI

RUKMANI VARATHARAJAN ENGINEERING COLLEGE, SEMBODAI

hereby declare that I have attended the FDTP on CS 6601 - Distributed System.

held at E.G.S. Pillay Engineering College, Nagapattinam

during the period from 15-12-2018 to 28-12-2018

I also confirm that in the above mentioned period I am not involved in any other official work.

Faisal  
28/12/18  
Signature of the Participant with date

ATTESTED

[Signature]  
Dr. S. RAMABHARAN, M.E., Ph.D.,  
PRINCIPAL

E.G.S. Pillay Engineering College,  
Thethi. Nagore - 611 002.  
Nagapattinam (Dt) Tamil Nadu.



# CENTRE FOR FACULTY DEVELOPMENT

Anna University, Chennai-600025.

**FACULTY DEVELOPMENT TRAINING PROGRAMME - Winter Vacation-2018**

## DECLARATION FORM

Dr. / <sup>✓</sup>Mr. / Mrs. / Ms. .... M. VENKATESHWARAN .....

working as..... Assistant professor / CSE in the college of .....

..... Arasu Engineering college, Kumbakonam .....

hereby declare that I have attended the FDTP on ..CS6601- Distributed system .....

held at ..... E. G. S. Pillay Engineering college .....

during the period from ..... 15.12.2018 ..... to ..... 28.12.2018 .....

**I also confirm that in the above mentioned period I am not involved in any other official work.**

  
Signature of the Participant with date

**ATTESTED**

  
**Dr. S. RAMABALAN, M.E., Ph.D.,**  
PRINCIPAL

**E.G.S. Pillay Engineering College,**  
Thethi, Nagore - 611 002.  
Nagapattinam (Dt) Tamil Nadu.

# CENTRE FOR FACULTY DEVELOPMENT

Anna University, Chennai-600025.

**FACULTY DEVELOPMENT TRAINING PROGRAMME - Winter Vacation-2018**

## DECLARATION FORM

Dr. / Mr. / Mrs. / Ms. SATHYA . V

working as Assistant Professor in the college of AVC College  
of Engineering

hereby declare that I have attended the FDTP on CS6801 - Distributed Systems

held at E.G.S. PILLAY ENGINEERING COLLEGE

during the period from 15/12/2018 to 28/12/2018

I also confirm that in the above mentioned period I am not involved in any other official work.

Sr 15/12/18  
Signature of the Participant with date

**ATTESTED**

Sr  
**Dr. S. RAMABALAN, M.E., Ph.D.,**  
**PRINCIPAL**

**E.G.S. Pillay Engineering College,**  
**Thethi, Nagore - 611 002.**  
**Nagapattinam (Dt) Tamil Nadu.**

# CENTRE FOR FACULTY DEVELOPMENT

Anna University, Chennai-600025.

**FACULTY DEVELOPMENT TRAINING PROGRAMME - Winter Vacation-2018**

## DECLARATION FORM

Dr. / Mr. / Mrs. / Ms.  B.N. Kanthulu  
working as Assistant Prof in the college of A.V.C college  
of Engineering  
hereby declare that I have attended the FDTP on Distributed System  
held at E.G.S Pillay Engineering college, Nagapattinam  
during the period from 15/12/18 to 28/12/18

I also confirm that in the above mentioned period I am not involved in any other official work.

  
Signature of the Participant with date 15/12/18

ATTESTED

  
Dr. S. RAMABALAN, M.E., Ph.D.,  
PRINCIPAL

E.G.S. Pillay Engineering College,  
Thethi. Nagore - 611 002.  
Nagapattinam (Dt) Tamil Nadu

# CENTRE FOR FACULTY DEVELOPMENT

Anna University, Chennai-600025.

**FACULTY DEVELOPMENT TRAINING PROGRAMME - Winter Vacation-2018**

## DECLARATION FORM

Dr. / Mr. / Mrs. / Ms. .... V. Ezhilarasi .....

working as ..... Asst. Prof. / IT ..... in the college of ..... AVCEE .....

hereby declare that I have attended the FDTP on ..... Distributed Systems .....

held at ..... E.G.S. Pillay Engg. College .....

during the period from ..... 15/12/18 ..... to ..... 28/12/18 .....

I also confirm that in the above mentioned period I am not involved in any other official work.

V. Ezhilarasi  
28/12/2018  
Signature of the Participant with date

**ATTESTED**  
[Signature]  
Dr. S. RAMABALAN, M.E., Ph.D.,  
PRINCIPAL  
E.G.S. Pillay Engineering College,  
Thethi, Nagore - 611 002,  
Nagapattinam (Dt) Tamil Nadu.



# CENTRE FOR FACULTY DEVELOPMENT

Anna University, Chennai-600025.

FACULTY DEVELOPMENT TRAINING PROGRAMME - Winter Vacation-2018

## DECLARATION FORM

Dr. / Mr. / Mrs. / Ms. <sup>v</sup>..... C. PALANICHAMY.....

working as..... ASSISTANT PROFESSOR in the college of ..CHENDHURAN.....

..... COLLEGE OF ENGINEERING AND TECHNOLOGY.....

hereby declare that I have attended the FDTP on ..... DISTRIBUTED SYSTEM.....

held at ..... E. G. S. PILLAY ENGINEERING COLLEGE, NAGAPATTINAM.....

during the period from ..... 15.12.2018..... to ..... 28.12.2018.....

I also confirm that in the above mentioned period I am not involved in any other official work.

  
28/12/18

Signature of the Participant with date

ATTESTED



Dr. S. RAMABALAN, M.E., Ph.D.,  
PRINCIPAL

E.G.S. Pillay Engineering College,  
Thethi, Nagore - 611 002,  
Nagapattinam (Dt) Tamil Nadu.

# CENTRE FOR FACULTY DEVELOPMENT

Anna University, Chennai-600025.

**FACULTY DEVELOPMENT TRAINING PROGRAMME - Winter Vacation-2018**

## DECLARATION FORM

Dr. / Mr. / Mrs. / Ms. M. KRISHNA DEVI

working as ASSISTANT PROFESSOR in the college of Chendhuran

College of Engineering & Technology

hereby declare that I have attended the FDTP on Distributed Systems

held at E.G.S. Pillay Engineering College, Nagapattinam

during the period from 15.12.18 to 28.12.18

I also confirm that in the above mentioned period I am not involved in any other official work.

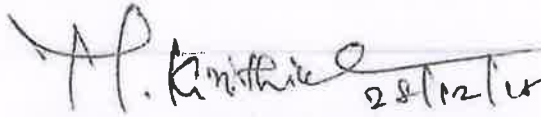
  
Signature of the Participant with date

ATTESTED

  
Dr. S. RAMABALAN, M.E., Ph.D.,  
PRINCIPAL

E.G.S. Pillay Engineering College,  
Thethi, Nagore - 611 002.  
Nagapattinam (Dt) Tamil Nadu.

# CENTRE FOR FACULTY DEVELOPMENT

Anna University, Chennai-600025.

FACULTY DEVELOPMENT TRAINING PROGRAMME - Winter Vacation-2018

## DECLARATION FORM

Dr. / Mr. / Mrs. / Ms. <sup>✓</sup> ..... V. T. A. ANITHA .....

working as ASSISTANT PROFESSOR in the college of CHENDHURAN .....

... COLLEGE OF ENGINEERING & TECHNOLOGY .....

hereby declare that I have attended the FDTP on DISTRIBUTED SYSTEMS .....

held at E.G.S.Pillay Engineering College, Nagapattinam .....

during the period from 15.12.2018 ..... 10 ..... 28.12.2018 .....

I also confirm that in the above mentioned period I am not involved in any other official work.

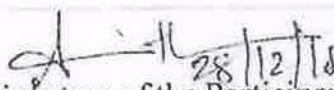
  
Signature of the Participant with date

ATTESTED

  
Dr. S. RAMABALAN, M.E., Ph.D.,  
PRINCIPAL

E.G.S. Pillay Engineering College,  
Thethi, Nagore - 611 002.  
Nagapattinam (Dt) Tamil Nadu.

# CENTRE FOR FACULTY DEVELOPMENT

Anna University, Chennai-600025.

FACULTY DEVELOPMENT TRAINING PROGRAMME - Winter Vacation-2018

## DECLARATION FORM

Dr. / Mr. / Mrs. / Ms. .... D. INFANTA JERSEY .....

working as..... AP/CSL .....in the college of Sir Issac .....

..... Newton College of Engineering and Technology, Nagore .....

hereby declare that I have attended the FDTP on Distributed Systems .....

held at E. G. S. Pillay Engineering College, Nagapattinam .....

during the period from 15.12.18 ..... to 28.12.18 .....

I also confirm that in the above mentioned period I am not involved in any other official work.

  
Signature of the Participant with date

ATTESTED

  
Dr. S. RAVABALAN, M.E., Ph.D.,  
PRINCIPAL

E.G.S. Pillay Engineering College,  
Thethi, Nagore - 611 002,  
Nagapattinam (Dt) Tamil Nadu.



# CENTRE FOR FACULTY DEVELOPMENT

Anna University, Chennai-600025.

**FACULTY DEVELOPMENT TRAINING PROGRAMME - Winter Vacation-2018**

## DECLARATION FORM

Dr./ Mr. / Mrs. / Ms. ..... M. Anitha .....

working as ..... AP / CSE ..... in the college of SIR ISSAC .....

..... NEWTON COLLEGE OF ENGINEERING & TECHNOLOGY, PAPPAL .....

hereby declare that I have attended the FDTP on DISTRIBUTED SYSTEMS .....

held at E. G. S. PILLAY ENGINEERING COLLEGE, Nagapattinam .....

during the period from 15/12/2018 to 28/12/2018 .....

I also confirm that in the above mentioned period I am not involved in any other official work.

  
15/12/2018  
Signature of the Participant with date

ATTESTED

  
Dr. S. RAMARAJAN, M.E., Ph.D.,  
PRINCIPAL

E.G.S. Pillay Engineering College,  
Thethi. Nagore - 611 002.  
Nagapattinam (Dt) Tamil Nadu.

# CENTRE FOR FACULTY DEVELOPMENT

Anna University, Chennai-600025.

**FACULTY DEVELOPMENT TRAINING PROGRAMME - Winter Vacation-2018**

## DECLARATION FORM

Dr. / Mr. / Mrs. / Ms. K. Manikande Kumaran  
working as Assistant Professor in the college of E.G.S.Pillay  
Engineering College, Nagapattinam  
hereby declare that I have attended the FDTP on Distributed System  
held at E.G.S.Pillay Engg. College, Nagapattinam  
during the period from 15/12/18 to 28/12/18

**I also confirm that in the above mentioned period I am not involved in any other official work.**

Subk 28/12/18  
Signature of the Participant with date

**ATTESTED**

[Signature]  
Dr. S. RAMABALAN, M.E., Ph.D.,

PRINCIPAL

E.G.S. Pillay Engineering College,

Thethi Nagore - 611 002

Nagapattinam (Dt) Tamil Nadu.

# CENTRE FOR FACULTY DEVELOPMENT

Anna University, Chennai-600025.

FACULTY DEVELOPMENT TRAINING PROGRAMME - Winter Vacation-2018

## DECLARATION FORM

Dr. / Mr. / Mrs. / Ms. .... A. Hema .....

working as Assistant Professor in the college of E. G. S. P. E. C (Autonomous)  
Nagapattinam - 611 002 .....

hereby declare that I have attended the FDTP on Distributed Systems  
held at E. G. S. P. E. C (Autonomous), Nagapattinam .....

during the period from 15.12.2018 to 28.12.2018 .....

I also confirm that in the above mentioned period I am not involved in any other  
official work.

  
28/12/18

Signature of the Participant with date

ATTESTED

  
Dr. S. RAMABALAN, M.E., Ph.D.,  
PRINCIPAL

E.G.S. Pillay Engineering College,  
Thethi, Nagore - 611 002.  
Nagapattinam (Dt) Tamil Nadu.

# CENTRE FOR FACULTY DEVELOPMENT

Anna University, Chennai-600025.

FACULTY DEVELOPMENT TRAINING PROGRAMME - Winter Vacation-2018

## DECLARATION FORM

Dr. / Mr. / Mrs. / Ms. N. Lakshya  
working as Assistant Professor in the college of E.G.S.P.E.C. (Autonomous)  
Nagapattinam - 611002  
hereby declare that I have attended the FDTP on Distributed Systems  
held at E.G.S.P.E.C. (Autonomous), Nagapattinam  
during the period from 15.12.2018 to 28.12.2018

I also confirm that in the above mentioned period I am not involved in any other official work.

  
Signature of the Participant with date 28.12.18

ATTESTED

  
Dr. S. RAJARAJAN, M.E., Ph.D.,  
PRINCIPAL

E.G.S. Pillay Engineering College,  
Thethi, Nagore - 611 002.  
Nagapattinam (Dt) Tamil Nadu.



# CENTRE FOR FACULTY DEVELOPMENT

Anna University, Chennai-600025.

**FACULTY DEVELOPMENT TRAINING PROGRAMME - Winter Vacation-2018**

## DECLARATION FORM

Dr./Mr./Mrs./Ms. GOKILA. R. G.

working as Asst. Professor in the college of

E.G.S. Pillay Engineering College

hereby declare that I have attended the FDTP on C#6601 - Distributed System

held at E.G.S. Pillay Engineering College

during the period from 15/12/18 to 28/12/18

**I also confirm that in the above mentioned period I am not involved in any other official work.**

R. R. R. - 15/12/18  
Signature of the Participant with date

**ATTESTED**

[Signature]  
**Dr. S. RAMABALAN, M.E., Ph.D.,  
PRINCIPAL**

**E.G.S. Pillay Engineering College,  
Thethi, Nagore - 611 002,  
Nagapattinam (Dt) Tamil Nadu.**

# CENTRE FOR FACULTY DEVELOPMENT

Anna University, Chennai-600025.

**FACULTY DEVELOPMENT TRAINING PROGRAMME - Winter Vacation-2018**

## DECLARATION FORM

Dr. / Mr. / Mrs. / Ms. .... S. Palani Murugan .....

working as..... Assistant Professor..... in the college of .. E.G.S. Pillay ..  
Engineering College, Nagapattinam .....

hereby declare that I have attended the FDTP on ..... Distributed Systems .....

held at ..... E.G.S. Pillay Engineering College, Nagapattinam .....

during the period from ..... 15-12-2018 to 28-12-2018 .....

**I also confirm that in the above mentioned period I am not involved in any other official work.**

  
Signature of the Participant with date

**ATTESTED**

  
**Dr. S. RAMABALAN, M.E., Ph.D.**

**PRINCIPAL**

**E.G.S. Pillay Engineering College,**

**Thethi, Nagore - 611 002.**

**Nagapattinam (Dt) Tamil Nadu.**

# CENTRE FOR FACULTY DEVELOPMENT

Anna University, Chennai-600025.

**FACULTY DEVELOPMENT TRAINING PROGRAMME - Winter Vacation-2018**

## DECLARATION FORM

Dr. / Mr. / Mrs. / Ms. G. ARUL SELVAN  
working as ASSISTANT PROFESSOR in the college of E.G.S. Pillay  
Engineering College, Nagapattinam  
hereby declare that I have attended the FDTP on CS 6601 - Distributed Systems  
held at E.G.S. Pillay Engineering College, Nagapattinam  
during the period from 15/12/18 to 29/12/18

I also confirm that in the above mentioned period I am not involved in any other official work.

  
Signature of the Participant with date

**ATTESTED**

  
**Dr. S. RAMABALAN, M.E., Ph.D.,  
PRINCIPAL**

**E.G.S. Pillay Engineering College,  
Thethi, Nagore - 611 002,  
Nagapattinam (Dt) Tamil Nadu.**

# CENTRE FOR FACULTY DEVELOPMENT

Anna University, Chennai-600025.

**FACULTY DEVELOPMENT TRAINING PROGRAMME - Winter Vacation-2018**

## DECLARATION FORM

✓  
Dr. / Mr. / Mrs. / Ms. .... K. BALASUBRAMANIAN .....

working as .... ASSOCIATE PROFESSOR ..... in the college of E.G.S. PILLAY .....  
ENGINEERING COLLEGE, NAGAPATTINAM .....

hereby declare that I have attended the FDTP on .... CS6601 - Distributed Systems .....

held at .... E.G.S. PILLAY ENGINEERING COLLEGE .....

during the period from .... 15.12.2018 ..... to .... 28.12.2018 .....

I also confirm that in the above mentioned period I am not involved in any other official work.

G. R. S. S. S. 28/12/18  
Signature of the Participant with

**ATTESTED**

[Signature]  
**Dr. S. RAMABALAN, M.E., Ph.D.,**  
**PRINCIPAL**  
**E.G.S. Pillay Engineering College,**  
**Thethi, Nagore - 611 002.**  
**Nagapattinam (Dt) Tamil Nadu.**



# CENTRE FOR FACULTY DEVELOPMENT

Anna University, Chennai-600025.

FACULTY DEVELOPMENT TRAINING PROGRAMME - Winter Vacation-2018

## FEEDBACK FORM

|  |  |
|--|--|
| Title of the Programme<br><b>Distributed systems</b> | Duration<br><b>15-12-18 - 20-12-18</b> |
|--|--|

1. Name & Designation **Dr. M. G. Kavitha, AP/CSE**

2. Name of the College **VCE Pattukkottai**

3. No. of Resource Persons Internal **8** External **8**

4. Comments about the following : (Please tick the relevant box e.g. 5 - highest, 1 - lowest)

i. Subject content  5  4  3  2  1

ii. Coverage of syllabus  5  4  3  2  1

iii. Technical Presentation by Internal Faculty  5  4  3  2  1

iv. Technical Presentation by External Faculty  5  4  3  2  1

v. Course Materials Supplied  5  4  3  2  1

vi. Tutorials  5  4  3  2  1

vii. Laboratory facilities / Site visit  5  4  3  2  1

5. Level of Excellence and Academic Standards of FDTP

i. Ability to identify, formulate and solve the problems  5  4  3  2  1

ii. Ability to use IT techniques and Tools to Deliver Lectures  5  4  3  2  1

6. Developed new skills / Improved the ones had already  5  4  3  2  1

7. The example and practical exercises helped to understand  5  4  3  2  1

8. Reception & Hospitality  5  4  3  2  1

9. Accommodation & Catering  5  4  3  2  1

11. Opinion / Suggestion / Effectiveness of the course :

**M. G. Kavitha**  
Signature of the Participant

Date : **20-12-18**

ATTESTED

**Dr. S. RAMABALAN, M.E., Ph.D.,**  
PRINCIPAL

**E.G.S. Pillay Engineering College,**  
Therai Nagar, 605 007  
Nadapattinam (Dt) Tamil Nadu

# CENTRE FOR FACULTY DEVELOPMENT

Anna University, Chennai-600025.

FACULTY DEVELOPMENT TRAINING PROGRAMME - Winter Vacation-2018

## FEEDBACK FORM

|   |  |
|---|--|
| Title of the Programme<br><i>CS 6601 - Distributed System</i> | Duration<br><i>15.12.2018 - 28.12.2018</i> |
|---|--|

1. Name & Designation *Dr. B. RAJESH*

2. Name of the College *University College of Engineering, Pattukkottai*

3. No. of Resource Persons Internal *8* External *8*

4. Comments about the following : (Please tick the relevant box e.g. 5 - highest, 1 - lowest)

i. Subject content  5  4  3  2  1

ii. Coverage of syllabus  5  4  3  2  1

iii. Technical Presentation by Internal Faculty  5  4  3  2  1

iv. Technical Presentation by External Faculty  5  4  3  2  1

v. Course Materials Supplied  5  4  3  2  1

vi. Tutorials  5  4  3  2  1

vii. Laboratory facilities / Site visit  5  4  3  2  1

5. Level of Excellence and Academic Standards of FDTP

i. Ability to Identify, formulate and solve the problems  5  4  3  2  1

ii. Ability to use IT techniques and Tools to Deliver Lecturer  5  4  3  2  1

6. Developed new skills / Improved the ones had already  5  4  3  2  1

7. The example and practical exercises helped to understand  5  4  3  2  1

8. Reception & Hospitality  5  4  3  2  1

9. Accommodation & Catering  5  4  3  2  1

11. Opinion / Suggestion / Effectiveness of the course :

*Good*

*B. Rajesh*  
Signature of the Participant

Date : *28.12.2018*

ATTESTED

*[Signature]*  
Dr. S. RAMABALAN, M.E., Ph.D.,  
PRINCIPAL

E.G.S. Pillay Engineering College,  
Thethi, Nagore - 611 002.

Tamil Nadu



# CENTRE FOR FACULTY DEVELOPMENT

Anna University, Chennai-600025.

## FACULTY DEVELOPMENT TRAINING PROGRAMME - Winter Vacation-2018

### FEEDBACK FORM

|  |                                 |
|--|---------------------------------|
| Title of the Programme<br>CS6601 Distributed Systems | Duration<br>15/12/18 - 28/12/18 |
|--|---------------------------------|

1. Name & Designation

Dr. S. Senthil Kumar

2. Name of the College

University College of Engineering Palakkad

3. No. of Resource Persons

Internal 8 External 8

4. Comments about the following : (Please tick the relevant box e.g. 5 - highest, 1 - lowest)

i. Subject content

5 4 3 2 1

ii. Coverage of syllabus

5 4 3 2 1

iii. Technical Presentation by Internal Faculty

5 4 3 2 1

iv. Technical Presentation by External Faculty

5 4 3 2 1

v. Course Materials Supplied

5 4 3 2 1

vi. Tutorials

5 4 3 2 1

vii. Laboratory facilities / Site visit

5 4 3 2 1

5. Level of Excellence and Academic Standards of FDTP

i. Ability to Identify, formulate and solve the problems

5 4 3 2 1

ii. Ability to use IT techniques and Tools to Deliver Lecturer

5 4 3 2 1

6. Developed new skills / Improved the ones had already

5 4 3 2 1

7. The example and practical exercises helped to understand

5 4 3 2 1

8. Reception & Hospitality

5 4 3 2 1

9. Accommodation & Catering

5 4 3 2 1

11. Opinion / Suggestion / Effectiveness of the course :

Good

Signature of the Participant

Date : 28/12/18

ATTESTED

Dr. S. RAMABALAN, M.E., Ph.D.,  
PRINCIPAL

E.G.S. Pillay Engineering College,  
Thethi, Nagore - 611 002.  
Nedupattinam (Dt) Tamil Nadu.

# CENTRE FOR FACULTY DEVELOPMENT

Anna University, Chennai-600025.

FACULTY DEVELOPMENT TRAINING PROGRAMME - Winter Vacation-2018

## FEEDBACK FORM

|   |   |
|---|---|
| Title of the Programme<br><b>CS6601 - Distributed Systems</b> | Duration<br><b>15.12.2018 to 28.12.2018</b> |
|---|---|

1. Name & Designation

**K. PREETHI**

2. Name of the College

**UCE - PKT**

3. No. of Resource Persons

Internal **8**

External **8**

4. Comments about the following : (Please tick the relevant box e.g. 5 - highest, 1 - lowest)

i. Subject content

5  4  3  2  1

ii. Coverage of syllabus

5  4  3  2  1

iii. Technical Presentation by Internal Faculty

5  4  3  2  1

iv. Technical Presentation by External Faculty

5  4  3  2  1

v. Course Materials Supplied

5  4  3  2  1

vi. Tutorials

5  4  3  2  1

vii. Laboratory facilities / Site visit

5  4  3  2  1

5. Level of Excellence and Academic Standards of FDTP

i. Ability to Identify, formulate and solve the problems

5  4  3  2  1

ii. Ability to use IT techniques and Tools to Deliver Lectures

5  4  3  2  1

6. Developed new skills / Improved the ones had already

5  4  3  2  1

7. The example and practical exercises helped to understand

5  4  3  2  1

8. Reception & Hospitality

5  4  3  2  1

9. Accommodation & Catering

5  4  3  2  1

11. Opinion / Suggestion / Effectiveness of the course :

**Good.**

**Signature of the Participant**

**Date : 28.12.18**

ATTESTED

**Dr. S. RAMABALAN, M.E., Ph.D.,  
PRINCIPAL**

**E.G.S. Pillay Engineering College,  
Thethi, Nagore - 611 002.**

**M. K. Pattinam (Dt. Tamil Nadu)**



# CENTRE FOR FACULTY DEVELOPMENT

Anna University, Chennai-600025.

## FACULTY DEVELOPMENT TRAINING PROGRAMME - Winter Vacation-2018

### FEEDBACK FORM

|  |  |
|--|--|
| Title of the Programme<br><b>Distributed Systems</b> | Duration<br><b>15.12.18 - 28.12.18</b> |
|--|--|

1. Name & Designation **Dr. N. KAURHA AP Maths**

2. Name of the College **UCE Pattukkottai**

3. No. of Resource Persons Internal **8** External **8**

4. Comments about the following : (Please tick the relevant box e.g. 5 - highest, 1 - lowest)

i. Subject content  5  4  3  2  1

ii. Coverage of syllabus  5  4  3  2  1

iii. Technical Presentation by Internal Faculty  5  4  3  2  1

iv. Technical Presentation by External Faculty  5  4  3  2  1

v. Course Materials Supplied  5  4  3  2  1

vi. Tutorials  5  4  3  2  1

vii. Laboratory facilities / Site visit  5  4  3  2  1

5. Level of Excellence and Academic Standards of FDTP

i. Ability to Identify, formulate and solve the problems  5  4  3  2  1

ii. Ability to use IT techniques and Tools to Deliver Lecturer  5  4  3  2  1

6. Developed new skills / Improved the ones had already.  5  4  3  2  1

7. The example and practical exercises helped to understand  5  4  3  2  1

8. Reception & Hospitality  5  4  3  2  1

9. Accommodation & Catering  5  4  3  2  1

11. Opinion / Suggestion / Effectiveness of the course :

  
Signature of the Participant

Date : **28.12.18**

ATTESTED

  
**Dr. S. RAMABALAN, M.E., Ph.D.,  
PRINCIPAL**

**E.G.S. Pillay Engineering College,  
Thethi, Nagore - 611 002.**

**Nagapattinam (Dt) Tamil Nadu.**

# CENTRE FOR FACULTY DEVELOPMENT

Anna University, Chennai-600025.

## FACULTY DEVELOPMENT TRAINING PROGRAMME - Winter Vacation-2018

### FEEDBACK FORM

|  |   |
|--|---|
| Title of the Programme<br><b>DISTRIBUTED SYSTEMS</b> | Duration<br><b>15/12/2018 to 28/12/2018</b> |
|--|---|

1. Name & Designation **MISS. E - SARANYA**

2. Name of the College **SIR ISSAC NEWTON COLLEGE OF ENGG & TECH**

3. No. of Resource Persons Internal **8** External **8**

4. Comments about the following : (Please tick the relevant box e.g. 5 - highest, 1 - lowest)

|   |                                    |                                    |                         |                         |                         |
|---|------------------------------------|------------------------------------|-------------------------|-------------------------|-------------------------|
| i. Subject content                              | <input checked="" type="radio"/> 5 | <input type="radio"/> 4            | <input type="radio"/> 3 | <input type="radio"/> 2 | <input type="radio"/> 1 |
| ii. Coverage of syllabus                        | <input checked="" type="radio"/> 5 | <input type="radio"/> 4            | <input type="radio"/> 3 | <input type="radio"/> 2 | <input type="radio"/> 1 |
| iii. Technical Presentation by Internal Faculty | <input type="radio"/> 5            | <input checked="" type="radio"/> 4 | <input type="radio"/> 3 | <input type="radio"/> 2 | <input type="radio"/> 1 |
| iv. Technical Presentation by External Faculty  | <input type="radio"/> 5            | <input checked="" type="radio"/> 4 | <input type="radio"/> 3 | <input type="radio"/> 2 | <input type="radio"/> 1 |
| v. Course Materials Supplied                    | <input type="radio"/> 5            | <input checked="" type="radio"/> 4 | <input type="radio"/> 3 | <input type="radio"/> 2 | <input type="radio"/> 1 |
| vi. Tutorials                                   | <input checked="" type="radio"/> 5 | <input type="radio"/> 4            | <input type="radio"/> 3 | <input type="radio"/> 2 | <input type="radio"/> 1 |
| vii. Laboratory facilities / Site visit         | <input checked="" type="radio"/> 5 | <input type="radio"/> 4            | <input type="radio"/> 3 | <input type="radio"/> 2 | <input type="radio"/> 1 |

5. Level of Excellence and Academic Standards of FDTP

|  |                         |                                    |                         |                         |                         |
|--|-------------------------|------------------------------------|-------------------------|-------------------------|-------------------------|
| i. Ability to Identify, formulate and solve the problems       | <input type="radio"/> 5 | <input checked="" type="radio"/> 4 | <input type="radio"/> 3 | <input type="radio"/> 2 | <input type="radio"/> 1 |
| ii. Ability to use IT techniques and Tools to Deliver Lecturer | <input type="radio"/> 5 | <input checked="" type="radio"/> 4 | <input type="radio"/> 3 | <input type="radio"/> 2 | <input type="radio"/> 1 |

6. Developed new skills / improved the ones had already

|                         |                                    |                         |                         |                         |
|-------------------------|------------------------------------|-------------------------|-------------------------|-------------------------|
| <input type="radio"/> 5 | <input checked="" type="radio"/> 4 | <input type="radio"/> 3 | <input type="radio"/> 2 | <input type="radio"/> 1 |
|-------------------------|------------------------------------|-------------------------|-------------------------|-------------------------|

7. The example and practical exercises helped to understand

|                         |                                    |                         |                         |                         |
|-------------------------|------------------------------------|-------------------------|-------------------------|-------------------------|
| <input type="radio"/> 5 | <input checked="" type="radio"/> 4 | <input type="radio"/> 3 | <input type="radio"/> 2 | <input type="radio"/> 1 |
|-------------------------|------------------------------------|-------------------------|-------------------------|-------------------------|

8. Reception & Hospitality

|                                    |                         |                         |                         |                         |
|------------------------------------|-------------------------|-------------------------|-------------------------|-------------------------|
| <input checked="" type="radio"/> 5 | <input type="radio"/> 4 | <input type="radio"/> 3 | <input type="radio"/> 2 | <input type="radio"/> 1 |
|------------------------------------|-------------------------|-------------------------|-------------------------|-------------------------|

9. Accommodation & Catering

|                                    |                         |                         |                         |                         |
|------------------------------------|-------------------------|-------------------------|-------------------------|-------------------------|
| <input checked="" type="radio"/> 5 | <input type="radio"/> 4 | <input type="radio"/> 3 | <input type="radio"/> 2 | <input type="radio"/> 1 |
|------------------------------------|-------------------------|-------------------------|-------------------------|-------------------------|

11. Opinion / Suggestion / Effectiveness of the course :

**GOOD**

**ATTESTED**  
*[Signature]*  
**Dr. S. RAMABALAN, M.E., Ph.D.,**  
**PRINCIPAL**

*[Signature]*  
Signature of the Participant

Date : **28/12/2018**



# CENTRE FOR FACULTY DEVELOPMENT

Anna University, Chennai-600025.

## FACULTY DEVELOPMENT TRAINING PROGRAMME - Winter Vacation-2018

### FEEDBACK FORM

|   |   |
|---|---|
| Title of the Programme<br><i>Distributed System</i> | Duration<br><i>15-12-18 to 28-12-18</i> |
|---|---|

1. Name & Designation *A. Indira Devi k AP*

2. Name of the College *Sir Isaac Newton College of Engineering & Technology*

3. No. of Resource Persons  
Internal *8* External *8*

4. Comments about the following : (Please tick the relevant box e.g. 5 - highest, 1 - lowest)

|   |                                    |                                    |                         |                         |                         |
|---|------------------------------------|------------------------------------|-------------------------|-------------------------|-------------------------|
| i. Subject content                              | <input type="radio"/> 5            | <input checked="" type="radio"/> 4 | <input type="radio"/> 3 | <input type="radio"/> 2 | <input type="radio"/> 1 |
| ii. Coverage of syllabus                        | <input checked="" type="radio"/> 5 | <input type="radio"/> 4            | <input type="radio"/> 3 | <input type="radio"/> 2 | <input type="radio"/> 1 |
| iii. Technical Presentation by Internal Faculty | <input checked="" type="radio"/> 5 | <input type="radio"/> 4            | <input type="radio"/> 3 | <input type="radio"/> 2 | <input type="radio"/> 1 |
| iv. Technical Presentation by External Faculty  | <input checked="" type="radio"/> 5 | <input type="radio"/> 4            | <input type="radio"/> 3 | <input type="radio"/> 2 | <input type="radio"/> 1 |
| v. Course Materials Supplied                    | <input type="radio"/> 5            | <input checked="" type="radio"/> 4 | <input type="radio"/> 3 | <input type="radio"/> 2 | <input type="radio"/> 1 |
| vi. Tutorials                                   | <input checked="" type="radio"/> 5 | <input type="radio"/> 4            | <input type="radio"/> 3 | <input type="radio"/> 2 | <input type="radio"/> 1 |
| vii. Laboratory facilities / Site visit         | <input checked="" type="radio"/> 5 | <input type="radio"/> 4            | <input type="radio"/> 3 | <input type="radio"/> 2 | <input type="radio"/> 1 |

5. Level of Excellence and Academic Standards of FDTP

|  |                         |                                    |                         |                         |                         |
|--|-------------------------|------------------------------------|-------------------------|-------------------------|-------------------------|
| i. Ability to Identify, formulate and solve the problems       | <input type="radio"/> 5 | <input checked="" type="radio"/> 4 | <input type="radio"/> 3 | <input type="radio"/> 2 | <input type="radio"/> 1 |
| ii. Ability to use IT techniques and Tools to Deliver Lecturer | <input type="radio"/> 5 | <input checked="" type="radio"/> 4 | <input type="radio"/> 3 | <input type="radio"/> 2 | <input type="radio"/> 1 |

6. Developed new skills / improved the ones had already

|                                    |                         |                         |                         |                         |
|------------------------------------|-------------------------|-------------------------|-------------------------|-------------------------|
| <input checked="" type="radio"/> 5 | <input type="radio"/> 4 | <input type="radio"/> 3 | <input type="radio"/> 2 | <input type="radio"/> 1 |
|------------------------------------|-------------------------|-------------------------|-------------------------|-------------------------|

7. The example and practical exercises helped to understand

|                         |                                    |                         |                         |                         |
|-------------------------|------------------------------------|-------------------------|-------------------------|-------------------------|
| <input type="radio"/> 5 | <input checked="" type="radio"/> 4 | <input type="radio"/> 3 | <input type="radio"/> 2 | <input type="radio"/> 1 |
|-------------------------|------------------------------------|-------------------------|-------------------------|-------------------------|

8. Reception & Hospitality

|                                    |                         |                         |                         |                         |
|------------------------------------|-------------------------|-------------------------|-------------------------|-------------------------|
| <input checked="" type="radio"/> 5 | <input type="radio"/> 4 | <input type="radio"/> 3 | <input type="radio"/> 2 | <input type="radio"/> 1 |
|------------------------------------|-------------------------|-------------------------|-------------------------|-------------------------|

9. Accommodation & Catering

|                         |                                    |                         |                         |                         |
|-------------------------|------------------------------------|-------------------------|-------------------------|-------------------------|
| <input type="radio"/> 5 | <input checked="" type="radio"/> 4 | <input type="radio"/> 3 | <input type="radio"/> 2 | <input type="radio"/> 1 |
|-------------------------|------------------------------------|-------------------------|-------------------------|-------------------------|

11. Opinion / Suggestion / Effectiveness of the course :

*Good*

ATTESTED

*[Signature]*  
Dr. S. RAMABALAN, M.E., Ph.D.  
PRINCIPAL

E.G.S. Pillay Engineering College,  
Thethi, Nagore - 611 007  
Nadapattinam (D)

*A. Indira Devi*  
Signature of the Participant

Date : *28/12/18*

# CENTRE FOR FACULTY DEVELOPMENT

Anna University, Chennai-600025.

## FACULTY DEVELOPMENT TRAINING PROGRAMME - Winter Vacation-2018

### FEEDBACK FORM

|  |   |
|--|---|
| Title of the Programme<br><i>Distributed Systems</i> | Duration<br><i>15-12-18 to 28-12-18</i> |
|--|---|

1. Name & Designation *G. Saranya & AP*

2. Name of the College *Sri Isaac Newton College of Engineering & Technology*

3. No. of Resource Persons Internal  External

4. Comments about the following : (Please tick the relevant box e.g. 5 - highest, 1 - lowest)

|   |                                    |                                    |                         |                         |                         |
|---|------------------------------------|------------------------------------|-------------------------|-------------------------|-------------------------|
| i. Subject content                              | <input checked="" type="radio"/> 5 | <input type="radio"/> 4            | <input type="radio"/> 3 | <input type="radio"/> 2 | <input type="radio"/> 1 |
| ii. Coverage of syllabus                        | <input checked="" type="radio"/> 5 | <input type="radio"/> 4            | <input type="radio"/> 3 | <input type="radio"/> 2 | <input type="radio"/> 1 |
| iii. Technical Presentation by Internal Faculty | <input type="radio"/> 5            | <input checked="" type="radio"/> 4 | <input type="radio"/> 3 | <input type="radio"/> 2 | <input type="radio"/> 1 |
| iv. Technical Presentation by External Faculty  | <input type="radio"/> 5            | <input checked="" type="radio"/> 4 | <input type="radio"/> 3 | <input type="radio"/> 2 | <input type="radio"/> 1 |
| v. Course Materials Supplied                    | <input type="radio"/> 5            | <input checked="" type="radio"/> 4 | <input type="radio"/> 3 | <input type="radio"/> 2 | <input type="radio"/> 1 |
| vi. Tutorials                                   | <input checked="" type="radio"/> 5 | <input type="radio"/> 4            | <input type="radio"/> 3 | <input type="radio"/> 2 | <input type="radio"/> 1 |
| vii. Laboratory facilities / Site visit         | <input type="radio"/> 5            | <input checked="" type="radio"/> 4 | <input type="radio"/> 3 | <input type="radio"/> 2 | <input type="radio"/> 1 |

5. Level of Excellence and Academic Standards of FDTP

|  |                         |                                    |                         |                         |                         |
|--|-------------------------|------------------------------------|-------------------------|-------------------------|-------------------------|
| i. Ability to Identify, formulate and solve the problems       | <input type="radio"/> 5 | <input checked="" type="radio"/> 4 | <input type="radio"/> 3 | <input type="radio"/> 2 | <input type="radio"/> 1 |
| ii. Ability to use IT techniques and Tools to Deliver Lecturer | <input type="radio"/> 5 | <input checked="" type="radio"/> 4 | <input type="radio"/> 3 | <input type="radio"/> 2 | <input type="radio"/> 1 |

6. Developed new skills / improved the ones had already  5  4  3  2  1

7. The example and practical exercises helped to understand  5  4  3  2  1

8. Reception & Hospitality  5  4  3  2  1

9. Accommodation & Catering  5  4  3  2  1

11. Opinion / Suggestion / Effectiveness of the course :

*Good*

ATTESTED

*[Signature]*  
**Dr. S. RAMABALAN, M.E., Ph.D.,**  
PRINCIPAL

*[Signature]*  
Signature of the Participant

Date : *28/12/18*



# CENTRE FOR FACULTY DEVELOPMENT

Anna University, Chennai-600025.

## FACULTY DEVELOPMENT TRAINING PROGRAMME - Winter Vacation-2018

### FEEDBACK FORM

|   |  |
|---|--|
| Title of the Programme<br><b>TWO WEEKS FDTP ON CS6601<br/>DISTRIBUTED SYSTEM.</b> | Duration<br><b>2 WEEKS.<br/>15-12-18 To 28-12-18</b> |
|---|--|

|  |
|--|
| 1. Name & Designation<br><b>M. MDHAMED FAISAL, Asst. Prof / CSE</b>          |
| 2. Name of the College<br><b>SEMBODAI RUKMANI VARATHARAJAN ENGG College.</b> |
| 3. No. of Resource Persons<br>Internal <b>8</b> External <b>8</b>            |

4. Comments about the following : (Please tick the relevant box e.g. 5 - highest, 1 - lowest)

|  |                                    |                                    |                         |                         |                         |
|--|------------------------------------|------------------------------------|-------------------------|-------------------------|-------------------------|
| i. Subject content   | <input checked="" type="radio"/> 5 | <input type="radio"/> 4            | <input type="radio"/> 3 | <input type="radio"/> 2 | <input type="radio"/> 1 |
| ii. Coverage of syllabus                                       | <input checked="" type="radio"/> 5 | <input type="radio"/> 4            | <input type="radio"/> 3 | <input type="radio"/> 2 | <input type="radio"/> 1 |
| iii. Technical Presentation by Internal Faculty                | <input checked="" type="radio"/> 5 | <input type="radio"/> 4            | <input type="radio"/> 3 | <input type="radio"/> 2 | <input type="radio"/> 1 |
| iv. Technical Presentation by External Faculty                 | <input checked="" type="radio"/> 5 | <input type="radio"/> 4            | <input type="radio"/> 3 | <input type="radio"/> 2 | <input type="radio"/> 1 |
| v. Course Materials Supplied                                   | <input checked="" type="radio"/> 5 | <input type="radio"/> 4            | <input type="radio"/> 3 | <input type="radio"/> 2 | <input type="radio"/> 1 |
| vi. Tutorials  | <input checked="" type="radio"/> 5 | <input type="radio"/> 4            | <input type="radio"/> 3 | <input type="radio"/> 2 | <input type="radio"/> 1 |
| vii. Laboratory facilities / Site visit                        | <input checked="" type="radio"/> 5 | <input type="radio"/> 4            | <input type="radio"/> 3 | <input type="radio"/> 2 | <input type="radio"/> 1 |
| 5. Level of Excellence and Academic Standards of FDTP          |                                    |                                    |                         |                         |                         |
| i. Ability to Identify, formulate and solve the problems       | <input checked="" type="radio"/> 5 | <input type="radio"/> 4            | <input type="radio"/> 3 | <input type="radio"/> 2 | <input type="radio"/> 1 |
| ii. Ability to use IT techniques and Tools to Deliver Lecturer | <input type="radio"/> 5            | <input checked="" type="radio"/> 4 | <input type="radio"/> 3 | <input type="radio"/> 2 | <input type="radio"/> 1 |
| 6. Developed new skills / improved the ones had already        | <input type="radio"/> 5            | <input checked="" type="radio"/> 4 | <input type="radio"/> 3 | <input type="radio"/> 2 | <input type="radio"/> 1 |
| 7. The example and practical exercises helped to understand    | <input checked="" type="radio"/> 5 | <input type="radio"/> 4            | <input type="radio"/> 3 | <input type="radio"/> 2 | <input type="radio"/> 1 |
| 8. Reception & Hospitality                                     | <input checked="" type="radio"/> 5 | <input type="radio"/> 4            | <input type="radio"/> 3 | <input type="radio"/> 2 | <input type="radio"/> 1 |
| 9. Accommodation & Catering                                    | <input checked="" type="radio"/> 5 | <input type="radio"/> 4            | <input type="radio"/> 3 | <input type="radio"/> 2 | <input type="radio"/> 1 |

11. Opinion / Suggestion / Effectiveness of the course :

*Pls. consider the duration.  
its too long.*

ATTESTED

**Dr. S. RAMABALAN, M.E., Ph.D.**  
PRINCIPAL

*Faisal*

Signature of the Participant

Date : 28.12.18

**E.G.S. Pillay Engineering College,**  
Thethi Nagore - 611 002.  
Nagapattinam (Dt) Tamil Nadu.

# CENTRE FOR FACULTY DEVELOPMENT

Anna University, Chennai-600025.

## FACULTY DEVELOPMENT TRAINING PROGRAMME - Winter Vacation-2018

### FEEDBACK FORM

|  |   |
|--|---|
| Title of the Programme<br>FDTP on CS6601 - DISTRIBUTED SYSTEMS | Duration<br>TWO WEEKS<br>15-12-18 to 28-12-18 |
|--|---|

|  |
|--|
| 1. Name & Designation<br>M. VENKATESHWARAN & Assistant professor |
| 2. Name of the College<br>ARASU ENGINEERING COLLEGE              |
| 3. No. of Resource Persons<br>Internal 8 External 8              |

4. Comments about the following : (Please tick the relevant box e.g. 5 - highest, 1 - lowest)

|  |                                    |                                    |                                    |                         |                         |
|--|------------------------------------|------------------------------------|------------------------------------|-------------------------|-------------------------|
| i. Subject content   | <input checked="" type="radio"/> 5 | <input type="radio"/> 4            | <input type="radio"/> 3            | <input type="radio"/> 2 | <input type="radio"/> 1 |
| ii. Coverage of syllabus                                       | <input checked="" type="radio"/> 5 | <input type="radio"/> 4            | <input type="radio"/> 3            | <input type="radio"/> 2 | <input type="radio"/> 1 |
| iii. Technical Presentation by Internal Faculty                | <input checked="" type="radio"/> 5 | <input type="radio"/> 4            | <input type="radio"/> 3            | <input type="radio"/> 2 | <input type="radio"/> 1 |
| iv. Technical Presentation by External Faculty                 | <input checked="" type="radio"/> 5 | <input type="radio"/> 4            | <input type="radio"/> 3            | <input type="radio"/> 2 | <input type="radio"/> 1 |
| v. Course Materials Supplied                                   | <input type="radio"/> 5            | <input checked="" type="radio"/> 4 | <input type="radio"/> 3            | <input type="radio"/> 2 | <input type="radio"/> 1 |
| vi. Tutorials  | <input type="radio"/> 5            | <input checked="" type="radio"/> 4 | <input type="radio"/> 3            | <input type="radio"/> 2 | <input type="radio"/> 1 |
| vii. Laboratory facilities / Site visit                        | <input checked="" type="radio"/> 5 | <input type="radio"/> 4            | <input type="radio"/> 3            | <input type="radio"/> 2 | <input type="radio"/> 1 |
| 5. Level of Excellence and Academic Standards of FDTP          |                                    |                                    |                                    |                         |                         |
| i. Ability to Identify, formulate and solve the problems       | <input type="radio"/> 5            | <input checked="" type="radio"/> 4 | <input type="radio"/> 3            | <input type="radio"/> 2 | <input type="radio"/> 1 |
| ii. Ability to use IT techniques and Tools to Deliver Lecturer | <input checked="" type="radio"/> 5 | <input type="radio"/> 4            | <input type="radio"/> 3            | <input type="radio"/> 2 | <input type="radio"/> 1 |
| 6. Developed new skills / improved the ones had already        | <input type="radio"/> 5            | <input checked="" type="radio"/> 4 | <input type="radio"/> 3            | <input type="radio"/> 2 | <input type="radio"/> 1 |
| 7. The example and practical exercises helped to understand    | <input type="radio"/> 5            | <input checked="" type="radio"/> 4 | <input type="radio"/> 3            | <input type="radio"/> 2 | <input type="radio"/> 1 |
| 8. Reception & Hospitality                                     | <input type="radio"/> 5            | <input type="radio"/> 4            | <input checked="" type="radio"/> 3 | <input type="radio"/> 2 | <input type="radio"/> 1 |
| 9. Accommodation & Catering                                    | <input type="radio"/> 5            | <input checked="" type="radio"/> 4 | <input type="radio"/> 3            | <input type="radio"/> 2 | <input type="radio"/> 1 |

11. Opinion / Suggestion / Effectiveness of the course :

ATTESTED  
  
Dr. S. RAMABALAN, M.E., Ph.D.,  
PRINCIPAL

  
Signature of the Participant

Date : 28.12.2018

E.G.S. Pillay Engineering College,  
Thethi, Nagore - 611 002.

Atmapattanam (D) Tan: 044-24111111



# CENTRE FOR FACULTY DEVELOPMENT

Anna University, Chennai-600025.

## FACULTY DEVELOPMENT TRAINING PROGRAMME - Winter Vacation-2018

### FEEDBACK FORM

|  |                                  |
|--|----------------------------------|
| Title of the Programme<br>CS6601 - Distributed Systems | Duration<br>15/12/18 to 28/12/18 |
|--|----------------------------------|

|  |
|--|
| 1. Name & Designation<br>SATHYA V                    |
| 2. Name of the College<br>AVC College of Engineering |
| 3. No. of Resource Persons<br>Internal 8 External 8  |

4. Comments about the following : (Please tick the relevant box e.g. 5 - highest, 1 - lowest)

|  |                                    |                                    |                         |                         |                         |
|--|------------------------------------|------------------------------------|-------------------------|-------------------------|-------------------------|
| i. Subject content   | <input checked="" type="radio"/> 5 | <input type="radio"/> 4            | <input type="radio"/> 3 | <input type="radio"/> 2 | <input type="radio"/> 1 |
| ii. Coverage of syllabus                                       | <input checked="" type="radio"/> 5 | <input type="radio"/> 4            | <input type="radio"/> 3 | <input type="radio"/> 2 | <input type="radio"/> 1 |
| iii. Technical Presentation by Internal Faculty                | <input type="radio"/> 5            | <input checked="" type="radio"/> 4 | <input type="radio"/> 3 | <input type="radio"/> 2 | <input type="radio"/> 1 |
| iv. Technical Presentation by External Faculty                 | <input checked="" type="radio"/> 5 | <input type="radio"/> 4            | <input type="radio"/> 3 | <input type="radio"/> 2 | <input type="radio"/> 1 |
| v. Course Materials Supplied                                   | <input checked="" type="radio"/> 5 | <input type="radio"/> 4            | <input type="radio"/> 3 | <input type="radio"/> 2 | <input type="radio"/> 1 |
| vi. Tutorials  | <input type="radio"/> 5            | <input checked="" type="radio"/> 4 | <input type="radio"/> 3 | <input type="radio"/> 2 | <input type="radio"/> 1 |
| vii. Laboratory facilities / Site visit                        | <input checked="" type="radio"/> 5 | <input type="radio"/> 4            | <input type="radio"/> 3 | <input type="radio"/> 2 | <input type="radio"/> 1 |
| 5. Level of Excellence and Academic Standards of FDTP          |                                    |                                    |                         |                         |                         |
| i. Ability to Identify, formulate and solve the problems       | <input checked="" type="radio"/> 5 | <input type="radio"/> 4            | <input type="radio"/> 3 | <input type="radio"/> 2 | <input type="radio"/> 1 |
| ii. Ability to use IT techniques and Tools to Deliver Lecturer | <input checked="" type="radio"/> 5 | <input type="radio"/> 4            | <input type="radio"/> 3 | <input type="radio"/> 2 | <input type="radio"/> 1 |
| 6. Developed new skills / improved the ones had already        | <input checked="" type="radio"/> 5 | <input type="radio"/> 4            | <input type="radio"/> 3 | <input type="radio"/> 2 | <input type="radio"/> 1 |
| 7. The example and practical exercises helped to understand    | <input checked="" type="radio"/> 5 | <input type="radio"/> 4            | <input type="radio"/> 3 | <input type="radio"/> 2 | <input type="radio"/> 1 |
| 8. Reception & Hospitality                                     | <input checked="" type="radio"/> 5 | <input type="radio"/> 4            | <input type="radio"/> 3 | <input type="radio"/> 2 | <input type="radio"/> 1 |
| 9. Accommodation & Catering                                    | <input type="radio"/> 5            | <input checked="" type="radio"/> 4 | <input type="radio"/> 3 | <input type="radio"/> 2 | <input type="radio"/> 1 |

11. Opinion / Suggestion / Effectiveness of the course :

Can avoid internal faculty presentation with longer duration.

Signature of the Participant

Date : 28/12/18

ATTESTED

Dr. S. RAMABALAN, M.E., Ph.D.,  
PRINCIPAL

E.G.S. Pillay Engineering College,  
Thethi, Nagore - 611 002

# CENTRE FOR FACULTY DEVELOPMENT

Anna University, Chennai-600025.

## FACULTY DEVELOPMENT TRAINING PROGRAMME - Winter Vacation-2018

### FEEDBACK FORM

|   |                     |
|---|---------------------|
| Title of the Programme<br>FDTP on Distributed Systems | Duration<br>2 weeks |
|---|---------------------|

|   |
|---|
| 1. Name & Designation<br>B. N. KARTHICK AP          |
| 2. Name of the College<br>A.V.C College of Engg.    |
| 3. No. of Resource Persons<br>Internal 8 External 8 |

4. Comments about the following : (Please tick the relevant box e.g. 5 - highest, 1 - lowest)

|   |                                    |                                    |                         |                         |                         |
|---|------------------------------------|------------------------------------|-------------------------|-------------------------|-------------------------|
| i. Subject content                              | <input checked="" type="radio"/> 5 | <input type="radio"/> 4            | <input type="radio"/> 3 | <input type="radio"/> 2 | <input type="radio"/> 1 |
| ii. Coverage of syllabus                        | <input checked="" type="radio"/> 5 | <input type="radio"/> 4            | <input type="radio"/> 3 | <input type="radio"/> 2 | <input type="radio"/> 1 |
| iii. Technical Presentation by Internal Faculty | <input type="radio"/> 5            | <input checked="" type="radio"/> 4 | <input type="radio"/> 3 | <input type="radio"/> 2 | <input type="radio"/> 1 |
| iv. Technical Presentation by External Faculty  | <input checked="" type="radio"/> 5 | <input type="radio"/> 4            | <input type="radio"/> 3 | <input type="radio"/> 2 | <input type="radio"/> 1 |
| v. Course Materials Supplied                    | <input type="radio"/> 5            | <input checked="" type="radio"/> 4 | <input type="radio"/> 3 | <input type="radio"/> 2 | <input type="radio"/> 1 |
| vi. Tutorials                                   | <input checked="" type="radio"/> 5 | <input type="radio"/> 4            | <input type="radio"/> 3 | <input type="radio"/> 2 | <input type="radio"/> 1 |
| vii. Laboratory facilities / Site visit         | <input checked="" type="radio"/> 5 | <input type="radio"/> 4            | <input type="radio"/> 3 | <input type="radio"/> 2 | <input type="radio"/> 1 |

5. Level of Excellence and Academic Standards of FDTP

|  |                                    |                         |                         |                         |                         |
|--|------------------------------------|-------------------------|-------------------------|-------------------------|-------------------------|
| i. Ability to Identify, formulate and solve the problems       | <input checked="" type="radio"/> 5 | <input type="radio"/> 4 | <input type="radio"/> 3 | <input type="radio"/> 2 | <input type="radio"/> 1 |
| ii. Ability to use IT techniques and Tools to Deliver Lecturer | <input checked="" type="radio"/> 5 | <input type="radio"/> 4 | <input type="radio"/> 3 | <input type="radio"/> 2 | <input type="radio"/> 1 |

6. Developed new skills / improved the ones had already

7. The example and practical exercises helped to understand

8. Reception & Hospitality

9. Accommodation & Catering

11. Opinion / Suggestion / Effectiveness of the course :

Overall good experience on academically & personally

**ATTESTED**





Signature of the Participant

Date : 28/12/18

**Dr. S. RAMABALAN, M.E., Ph.D.,**  
**PRINCIPAL**

**E.G.S. Pillay Engineering College,**  
Thethi, Nagore



# CENTRE FOR FACULTY DEVELOPMENT

Anna University, Chennai-600025.

## FACULTY DEVELOPMENT TRAINING PROGRAMME - Winter Vacation-2018

### FEEDBACK FORM

|  |  |
|--|--|
| Title of the Programme<br><i>Distributed Systems</i> | Duration<br><i>15/12/18 - 28/12/18</i> |
|--|--|

1. Name & Designation *V. Ezhilarasi Asst. Prof / IT*

2. Name of the College *AVC College of Engineering*

3. No. of Resource Persons Internal *8* External *8*

4. Comments about the following : (Please tick the relevant box e.g. 5 - highest, 1 - lowest)

|   |                                    |                                    |                         |                         |                         |
|---|------------------------------------|------------------------------------|-------------------------|-------------------------|-------------------------|
| i. Subject content                              | <input checked="" type="radio"/> 5 | <input type="radio"/> 4            | <input type="radio"/> 3 | <input type="radio"/> 2 | <input type="radio"/> 1 |
| ii. Coverage of syllabus                        | <input type="radio"/> 5            | <input checked="" type="radio"/> 4 | <input type="radio"/> 3 | <input type="radio"/> 2 | <input type="radio"/> 1 |
| iii. Technical Presentation by Internal Faculty | <input checked="" type="radio"/> 5 | <input type="radio"/> 4            | <input type="radio"/> 3 | <input type="radio"/> 2 | <input type="radio"/> 1 |
| iv. Technical Presentation by External Faculty. | <input type="radio"/> 5            | <input checked="" type="radio"/> 4 | <input type="radio"/> 3 | <input type="radio"/> 2 | <input type="radio"/> 1 |
| v. Course Materials Supplied                    | <input checked="" type="radio"/> 5 | <input type="radio"/> 4            | <input type="radio"/> 3 | <input type="radio"/> 2 | <input type="radio"/> 1 |
| vi. Tutorials                                   | <input checked="" type="radio"/> 5 | <input type="radio"/> 4            | <input type="radio"/> 3 | <input type="radio"/> 2 | <input type="radio"/> 1 |
| vii. Laboratory facilities / Site visit         | <input type="radio"/> 5            | <input type="radio"/> 4            | <input type="radio"/> 3 | <input type="radio"/> 2 | <input type="radio"/> 1 |

5. Level of Excellence and Academic Standards of FDTP

|  |                                    |                         |                         |                         |                         |
|--|------------------------------------|-------------------------|-------------------------|-------------------------|-------------------------|
| i. Ability to Identify, formulate and solve the problems       | <input checked="" type="radio"/> 5 | <input type="radio"/> 4 | <input type="radio"/> 3 | <input type="radio"/> 2 | <input type="radio"/> 1 |
| ii. Ability to use IT techniques and Tools to Deliver Lecturer | <input checked="" type="radio"/> 5 | <input type="radio"/> 4 | <input type="radio"/> 3 | <input type="radio"/> 2 | <input type="radio"/> 1 |

6. Developed new skills / improved the ones had already

|                         |                                    |                         |                         |                         |
|-------------------------|------------------------------------|-------------------------|-------------------------|-------------------------|
| <input type="radio"/> 5 | <input checked="" type="radio"/> 4 | <input type="radio"/> 3 | <input type="radio"/> 2 | <input type="radio"/> 1 |
|-------------------------|------------------------------------|-------------------------|-------------------------|-------------------------|

7. The example and practical exercises helped to understand

|                                    |                         |                         |                         |                         |
|------------------------------------|-------------------------|-------------------------|-------------------------|-------------------------|
| <input checked="" type="radio"/> 5 | <input type="radio"/> 4 | <input type="radio"/> 3 | <input type="radio"/> 2 | <input type="radio"/> 1 |
|------------------------------------|-------------------------|-------------------------|-------------------------|-------------------------|

8. Reception & Hospitality

|                                    |                         |                         |                         |                         |
|------------------------------------|-------------------------|-------------------------|-------------------------|-------------------------|
| <input checked="" type="radio"/> 5 | <input type="radio"/> 4 | <input type="radio"/> 3 | <input type="radio"/> 2 | <input type="radio"/> 1 |
|------------------------------------|-------------------------|-------------------------|-------------------------|-------------------------|

9. Accommodation & Catering

|                                    |                         |                         |                         |                         |
|------------------------------------|-------------------------|-------------------------|-------------------------|-------------------------|
| <input checked="" type="radio"/> 5 | <input type="radio"/> 4 | <input type="radio"/> 3 | <input type="radio"/> 2 | <input type="radio"/> 1 |
|------------------------------------|-------------------------|-------------------------|-------------------------|-------------------------|

11. Opinion / Suggestion / Effectiveness of the course :

**ATTESTED**  
  
**Dr. S. RAMABALAN, M.E., Ph.D.,**  
**PRINCIPAL**

*V. Ezhilarasi*  
Signature of the Participant  
Date : *28/12/2018*

# CENTRE FOR FACULTY DEVELOPMENT

Anna University, Chennai-600025.

## FACULTY DEVELOPMENT TRAINING PROGRAMME - Winter Vacation-2018

### FEEDBACK FORM

|   |   |
|---|---|
| Title of the Programme<br><b>DISTRIBUTED SYSTEM</b> | Duration<br><b>15.12.18 to 28.12.18</b> |
|---|---|

|                            |   |                   |
|----------------------------|---|-------------------|
| 1. Name & Designation      | <b>C. PALANICHAMY , ASSISTANT PROFESSOR</b>         |                   |
| 2. Name of the College     | <b>CHENDHURAN COLLEGE OF ENGINEERING &amp; TECH</b> |                   |
| 3. No. of Resource Persons | Internal <b>8</b>                                   | External <b>8</b> |

4. Comments about the following : (Please tick the relevant box e.g. 5 - highest, 1 - lowest)

|   |                                    |                                    |                                    |                         |                         |
|---|------------------------------------|------------------------------------|------------------------------------|-------------------------|-------------------------|
| i. Subject content                              | <input type="radio"/> 5            | <input checked="" type="radio"/> 4 | <input type="radio"/> 3            | <input type="radio"/> 2 | <input type="radio"/> 1 |
| ii. Coverage of syllabus                        | <input type="radio"/> 5            | <input checked="" type="radio"/> 4 | <input type="radio"/> 3            | <input type="radio"/> 2 | <input type="radio"/> 1 |
| iii. Technical Presentation by Internal Faculty | <input checked="" type="radio"/> 5 | <input type="radio"/> 4            | <input type="radio"/> 3            | <input type="radio"/> 2 | <input type="radio"/> 1 |
| iv. Technical Presentation by External Faculty  | <input type="radio"/> 5            | <input type="radio"/> 4            | <input checked="" type="radio"/> 3 | <input type="radio"/> 2 | <input type="radio"/> 1 |
| v. Course Materials Supplied                    | <input checked="" type="radio"/> 5 | <input type="radio"/> 4            | <input type="radio"/> 3            | <input type="radio"/> 2 | <input type="radio"/> 1 |
| vi. Tutorials                                   | <input type="radio"/> 5            | <input checked="" type="radio"/> 4 | <input type="radio"/> 3            | <input type="radio"/> 2 | <input type="radio"/> 1 |
| vii. Laboratory facilities / Site visit         | <input checked="" type="radio"/> 5 | <input type="radio"/> 4            | <input type="radio"/> 3            | <input type="radio"/> 2 | <input type="radio"/> 1 |

5. Level of Excellence and Academic Standards of FDTP

|  |                         |                                    |                         |                         |                         |
|--|-------------------------|------------------------------------|-------------------------|-------------------------|-------------------------|
| i. Ability to Identify, formulate and solve the problems       | <input type="radio"/> 5 | <input checked="" type="radio"/> 4 | <input type="radio"/> 3 | <input type="radio"/> 2 | <input type="radio"/> 1 |
| ii. Ability to use IT techniques and Tools to Deliver Lecturer | <input type="radio"/> 5 | <input checked="" type="radio"/> 4 | <input type="radio"/> 3 | <input type="radio"/> 2 | <input type="radio"/> 1 |

|   |                                    |                                    |                         |                         |                         |
|---|------------------------------------|------------------------------------|-------------------------|-------------------------|-------------------------|
| 6. Developed new skills / improved the ones had already     | <input type="radio"/> 5            | <input checked="" type="radio"/> 4 | <input type="radio"/> 3 | <input type="radio"/> 2 | <input type="radio"/> 1 |
| 7. The example and practical exercises helped to understand | <input checked="" type="radio"/> 5 | <input type="radio"/> 4            | <input type="radio"/> 3 | <input type="radio"/> 2 | <input type="radio"/> 1 |
| 8. Reception & Hospitality                                  | <input checked="" type="radio"/> 5 | <input type="radio"/> 4            | <input type="radio"/> 3 | <input type="radio"/> 2 | <input type="radio"/> 1 |
| 9. Accommodation & Catering                                 | <input checked="" type="radio"/> 5 | <input type="radio"/> 4            | <input type="radio"/> 3 | <input type="radio"/> 2 | <input type="radio"/> 1 |

11. Opinion / Suggestion / Effectiveness of the course :

**ATTESTED**  
  
**Dr. S. RAMABALAN, M.E., Ph.D.,**  
**PRINCIPAL**  
**E.G.S. Pillay Engineering College,**  
**T. Nethi, Nagore - 611 002.**  
**Nagapattinam (Dt) Tamil Nadu**

  
Signature of the Participant

Date : **28.12.2018**



# CENTRE FOR FACULTY DEVELOPMENT

Anna University, Chennai-600025.

## FACULTY DEVELOPMENT TRAINING PROGRAMME - Winter Vacation-2018

### FEEDBACK FORM

|   |                                 |
|---|---------------------------------|
| Title of the Programme<br>Distributed Systems | Duration<br>15.12.18 - 28.12.18 |
|---|---------------------------------|

|  |
|--|
| 1. Name & Designation<br>M. KIRITHIKA DEVI, ASSISTANT PROFESSOR          |
| 2. Name of the College<br>CHENDHURAN COLLEGE OF ENGINEERING & TECHNOLOGY |
| 3. No. of Resource Persons<br>Internal 8 External 8                      |

4. Comments about the following : (Please tick the relevant box e.g. 5 - highest, 1 - lowest)

|   |   |   |   |   |   |
|---|---|---|---|---|---|
| i. Subject content                              | 5 | 4 | 3 | 2 | 1 |
| ii. Coverage of syllabus                        | 5 | 4 | 3 | 2 | 1 |
| iii. Technical Presentation by Internal Faculty | 5 | 4 | 3 | 2 | 1 |
| iv. Technical Presentation by External Faculty  | 5 | 4 | 3 | 2 | 1 |
| v. Course Materials Supplied                    | 5 | 4 | 3 | 2 | 1 |
| vi. Tutorials                                   | 5 | 4 | 3 | 2 | 1 |
| vii. Laboratory facilities / Site visit         | 5 | 4 | 3 | 2 | 1 |

5. Level of Excellence and Academic Standards of FDTP

|  |   |   |   |   |   |
|--|---|---|---|---|---|
| i. Ability to Identify, formulate and solve the problems       | 5 | 4 | 3 | 2 | 1 |
| ii. Ability to use IT techniques and Tools to Deliver Lecturer | 5 | 4 | 3 | 2 | 1 |

6. Developed new skills / improved the ones had already

|   |   |   |   |   |
|---|---|---|---|---|
| 5 | 4 | 3 | 2 | 1 |
|---|---|---|---|---|

7. The example and practical exercises helped to understand

|   |   |   |   |   |
|---|---|---|---|---|
| 5 | 4 | 3 | 2 | 1 |
|---|---|---|---|---|

8. Reception & Hospitality

|   |   |   |   |   |
|---|---|---|---|---|
| 5 | 4 | 3 | 2 | 1 |
|---|---|---|---|---|

9. Accommodation & Catering

|   |   |   |   |   |
|---|---|---|---|---|
| 5 | 4 | 3 | 2 | 1 |
|---|---|---|---|---|

11. Opinion / Suggestion / Effectiveness of the course :

ATTESTED

Dr. S. RAMABALAN, M.E., Ph.D.,  
PRINCIPAL

E.G.S. Pillay Engineering College,  
Theni, Nagore - 611 002.

Tamil Nadu.

H. Kirithika  
Signature of the Participant

Date : 28.12.2018

# CENTRE FOR FACULTY DEVELOPMENT

Anna University, Chennai-600025.

## FACULTY DEVELOPMENT TRAINING PROGRAMME - Winter Vacation-2018

### FEEDBACK FORM

|  |   |
|--|---|
| Title of the Programme<br><b>DISTRIBUTED SYSTEMS</b> | Duration<br><b>15.12.18 to 28.12.18</b> |
|--|---|

1. Name & Designation **V.T.A. ANITHA, Assistant Professor**

2. Name of the College **CHENDHURAN COLLEGE OF ENGG & TECHNOLOGY**

3. No. of Resource Persons Internal **8** External **8**

4. Comments about the following : (Please tick the relevant box e.g. 5 - highest, 1 - lowest)

- |   |                                    |                                    |                                    |                         |                         |
|---|------------------------------------|------------------------------------|------------------------------------|-------------------------|-------------------------|
| i. Subject content                              | <input type="radio"/> 5            | <input checked="" type="radio"/> 4 | <input type="radio"/> 3            | <input type="radio"/> 2 | <input type="radio"/> 1 |
| ii. Coverage of syllabus                        | <input type="radio"/> 5            | <input checked="" type="radio"/> 4 | <input type="radio"/> 3            | <input type="radio"/> 2 | <input type="radio"/> 1 |
| iii. Technical Presentation by Internal Faculty | <input checked="" type="radio"/> 5 | <input type="radio"/> 4            | <input type="radio"/> 3            | <input type="radio"/> 2 | <input type="radio"/> 1 |
| iv. Technical Presentation by External Faculty  | <input type="radio"/> 5            | <input type="radio"/> 4            | <input checked="" type="radio"/> 3 | <input type="radio"/> 2 | <input type="radio"/> 1 |
| v. Course Materials Supplied                    | <input checked="" type="radio"/> 5 | <input type="radio"/> 4            | <input type="radio"/> 3            | <input type="radio"/> 2 | <input type="radio"/> 1 |
| vi. Tutorials                                   | <input checked="" type="radio"/> 5 | <input type="radio"/> 4            | <input type="radio"/> 3            | <input type="radio"/> 2 | <input type="radio"/> 1 |
| vii. Laboratory facilities / Site visit         | <input checked="" type="radio"/> 5 | <input type="radio"/> 4            | <input type="radio"/> 3            | <input type="radio"/> 2 | <input type="radio"/> 1 |

5. Level of Excellence and Academic Standards of FDTP

- |  |                         |                                    |                         |                         |                         |
|--|-------------------------|------------------------------------|-------------------------|-------------------------|-------------------------|
| i. Ability to Identify, formulate and solve the problems       | <input type="radio"/> 5 | <input checked="" type="radio"/> 4 | <input type="radio"/> 3 | <input type="radio"/> 2 | <input type="radio"/> 1 |
| ii. Ability to use IT techniques and Tools to Deliver Lecturer | <input type="radio"/> 5 | <input checked="" type="radio"/> 4 | <input type="radio"/> 3 | <input type="radio"/> 2 | <input type="radio"/> 1 |

6. Developed new skills / improved the ones had already  5  4  3  2  1

7. The example and practical exercises helped to understand  5  4  3  2  1

8. Reception & Hospitality  5  4  3  2  1

9. Accommodation & Catering  5  4  3  2  1

11. Opinion / Suggestion / Effectiveness of the course :

ATTESTED

**Dr. S. RAMABALAN, M.E., Ph.D.,  
PRINCIPAL**

**E.G.S. Pillay Engineering College,**

Thethi, Nagore - 611 002.

Nadapattinam (Dt) Tamil Nadu.

Signature of the Participant

Date : 28.12.2018



# CENTRE FOR FACULTY DEVELOPMENT

Anna University, Chennai-600025.

## FACULTY DEVELOPMENT TRAINING PROGRAMME - Winter Vacation-2018

### FEEDBACK FORM

|  |   |
|--|---|
| Title of the Programme<br><i>Distributed Systems</i> | Duration<br><i>15.12.18 to 28.12.18</i> |
|--|---|

1. Name & Designation *Ms. D. INFANTA JERSEY*

2. Name of the College *Sri Isaac Newton College of Engg & Tech.*

3. No. of Resource Persons  
Internal *8* External *8*

4. Comments about the following : (Please tick the relevant box e.g. 5 - highest, 1 - lowest)

|   |                                    |                                    |                                    |                         |                         |
|---|------------------------------------|------------------------------------|------------------------------------|-------------------------|-------------------------|
| i. Subject content                              | <input checked="" type="radio"/> 5 | <input type="radio"/> 4            | <input type="radio"/> 3            | <input type="radio"/> 2 | <input type="radio"/> 1 |
| ii. Coverage of syllabus                        | <input checked="" type="radio"/> 5 | <input type="radio"/> 4            | <input type="radio"/> 3            | <input type="radio"/> 2 | <input type="radio"/> 1 |
| iii. Technical Presentation by Internal Faculty | <input type="radio"/> 5            | <input type="radio"/> 4            | <input checked="" type="radio"/> 3 | <input type="radio"/> 2 | <input type="radio"/> 1 |
| iv. Technical Presentation by External Faculty  | <input type="radio"/> 5            | <input checked="" type="radio"/> 4 | <input type="radio"/> 3            | <input type="radio"/> 2 | <input type="radio"/> 1 |
| v. Course Materials Supplied                    | <input type="radio"/> 5            | <input checked="" type="radio"/> 4 | <input type="radio"/> 3            | <input type="radio"/> 2 | <input type="radio"/> 1 |
| vi. Tutorials                                   | <input type="radio"/> 5            | <input type="radio"/> 4            | <input type="radio"/> 3            | <input type="radio"/> 2 | <input type="radio"/> 1 |
| vii. Laboratory facilities / Site visit         | <input checked="" type="radio"/> 5 | <input type="radio"/> 4            | <input type="radio"/> 3            | <input type="radio"/> 2 | <input type="radio"/> 1 |

5. Level of Excellence and Academic Standards of FDTP

|  |                                    |                                    |                         |                         |                         |
|--|------------------------------------|------------------------------------|-------------------------|-------------------------|-------------------------|
| i. Ability to Identify, formulate and solve the problems       | <input checked="" type="radio"/> 5 | <input type="radio"/> 4            | <input type="radio"/> 3 | <input type="radio"/> 2 | <input type="radio"/> 1 |
| ii. Ability to use IT techniques and Tools to Deliver Lecturer | <input type="radio"/> 5            | <input checked="" type="radio"/> 4 | <input type="radio"/> 3 | <input type="radio"/> 2 | <input type="radio"/> 1 |

6. Developed new skills / improved the ones had already

|                         |                                    |                         |                         |                         |
|-------------------------|------------------------------------|-------------------------|-------------------------|-------------------------|
| <input type="radio"/> 5 | <input checked="" type="radio"/> 4 | <input type="radio"/> 3 | <input type="radio"/> 2 | <input type="radio"/> 1 |
|-------------------------|------------------------------------|-------------------------|-------------------------|-------------------------|

7. The example and practical exercises helped to understand

|                         |                         |                                    |                         |                         |
|-------------------------|-------------------------|------------------------------------|-------------------------|-------------------------|
| <input type="radio"/> 5 | <input type="radio"/> 4 | <input checked="" type="radio"/> 3 | <input type="radio"/> 2 | <input type="radio"/> 1 |
|-------------------------|-------------------------|------------------------------------|-------------------------|-------------------------|

8. Reception & Hospitality

|                                    |                         |                         |                         |                         |
|------------------------------------|-------------------------|-------------------------|-------------------------|-------------------------|
| <input checked="" type="radio"/> 5 | <input type="radio"/> 4 | <input type="radio"/> 3 | <input type="radio"/> 2 | <input type="radio"/> 1 |
|------------------------------------|-------------------------|-------------------------|-------------------------|-------------------------|

9. Accommodation & Catering

|                                    |                         |                         |                         |                         |
|------------------------------------|-------------------------|-------------------------|-------------------------|-------------------------|
| <input checked="" type="radio"/> 5 | <input type="radio"/> 4 | <input type="radio"/> 3 | <input type="radio"/> 2 | <input type="radio"/> 1 |
|------------------------------------|-------------------------|-------------------------|-------------------------|-------------------------|

11. Opinion / Suggestion / Effectiveness of the course :

*Good*

ATTESTED

*[Signature]*  
Dr. S. RAMABALAN, M.E., Ph.D.,  
PRINCIPAL

E.G.S. Pillay Engineering College,  
Thiruvananthapuram  
State (04) Tamil Nadu

*[Signature]*  
Signature of the Participant

Date : *28.12.18*

# CENTRE FOR FACULTY DEVELOPMENT

Anna University, Chennai-600025.

## FACULTY DEVELOPMENT TRAINING PROGRAMME - Winter Vacation-2018

### FEEDBACK FORM

|  |   |
|--|---|
| Title of the Programme<br><b>DISTRIBUTED SYSTEMS</b> | Duration<br><b>15/12/2018 to 28/12/2018</b> |
|--|---|

|   |
|---|
| 1. Name & Designation<br><b>Miss. M. Anitha</b>   |
| 2. Name of the College<br><b>SINCE T</b>  |
| 3. No. of Resource Persons<br>Internal <input checked="" type="checkbox"/> 8 External <input checked="" type="checkbox"/> 8 |

4. Comments about the following : (Please tick the relevant box e.g. 5 - highest, 1 - lowest)

|   |                                    |                                    |                         |                         |                         |
|---|------------------------------------|------------------------------------|-------------------------|-------------------------|-------------------------|
| i. Subject content                              | <input checked="" type="radio"/> 5 | <input type="radio"/> 4            | <input type="radio"/> 3 | <input type="radio"/> 2 | <input type="radio"/> 1 |
| ii. Coverage of syllabus                        | <input checked="" type="radio"/> 5 | <input type="radio"/> 4            | <input type="radio"/> 3 | <input type="radio"/> 2 | <input type="radio"/> 1 |
| iii. Technical Presentation by Internal Faculty | <input type="radio"/> 5            | <input checked="" type="radio"/> 4 | <input type="radio"/> 3 | <input type="radio"/> 2 | <input type="radio"/> 1 |
| iv. Technical Presentation by External Faculty  | <input checked="" type="radio"/> 5 | <input type="radio"/> 4            | <input type="radio"/> 3 | <input type="radio"/> 2 | <input type="radio"/> 1 |
| v. Course Materials Supplied                    | <input type="radio"/> 5            | <input checked="" type="radio"/> 4 | <input type="radio"/> 3 | <input type="radio"/> 2 | <input type="radio"/> 1 |
| vi. Tutorials                                   | <input type="radio"/> 5            | <input checked="" type="radio"/> 4 | <input type="radio"/> 3 | <input type="radio"/> 2 | <input type="radio"/> 1 |
| vii. Laboratory facilities / Site visit         | <input type="radio"/> 5            | <input checked="" type="radio"/> 4 | <input type="radio"/> 3 | <input type="radio"/> 2 | <input type="radio"/> 1 |

5. Level of Excellence and Academic Standards of FDTP

|  |                                    |                                    |                         |                         |                         |
|--|------------------------------------|------------------------------------|-------------------------|-------------------------|-------------------------|
| i. Ability to Identify, formulate and solve the problems       | <input checked="" type="radio"/> 5 | <input type="radio"/> 4            | <input type="radio"/> 3 | <input type="radio"/> 2 | <input type="radio"/> 1 |
| ii. Ability to use IT techniques and Tools to Deliver Lecturer | <input type="radio"/> 5            | <input checked="" type="radio"/> 4 | <input type="radio"/> 3 | <input type="radio"/> 2 | <input type="radio"/> 1 |

6. Developed new skills / improved the ones had already

|                                    |                         |                         |                         |                         |
|------------------------------------|-------------------------|-------------------------|-------------------------|-------------------------|
| <input checked="" type="radio"/> 5 | <input type="radio"/> 4 | <input type="radio"/> 3 | <input type="radio"/> 2 | <input type="radio"/> 1 |
|------------------------------------|-------------------------|-------------------------|-------------------------|-------------------------|

7. The example and practical exercises helped to understand

|                                    |                         |                         |                         |                         |
|------------------------------------|-------------------------|-------------------------|-------------------------|-------------------------|
| <input checked="" type="radio"/> 5 | <input type="radio"/> 4 | <input type="radio"/> 3 | <input type="radio"/> 2 | <input type="radio"/> 1 |
|------------------------------------|-------------------------|-------------------------|-------------------------|-------------------------|

8. Reception & Hospitality

|                                    |                         |                         |                         |                         |
|------------------------------------|-------------------------|-------------------------|-------------------------|-------------------------|
| <input checked="" type="radio"/> 5 | <input type="radio"/> 4 | <input type="radio"/> 3 | <input type="radio"/> 2 | <input type="radio"/> 1 |
|------------------------------------|-------------------------|-------------------------|-------------------------|-------------------------|

9. Accommodation & Catering

|                                    |                         |                         |                         |                         |
|------------------------------------|-------------------------|-------------------------|-------------------------|-------------------------|
| <input checked="" type="radio"/> 5 | <input type="radio"/> 4 | <input type="radio"/> 3 | <input type="radio"/> 2 | <input type="radio"/> 1 |
|------------------------------------|-------------------------|-------------------------|-------------------------|-------------------------|

11. Opinion / Suggestion / Effectiveness of the course :

**Good**

**ATTESTED**

**Dr. S. RAMABALAN, M.E., Ph.D.,  
PRINCIPAL**

**E.G.S. Pillay Engineering College,  
Thethi, Nanguneri - 611 302,  
Nagapattinam (Dt) Tamil Nadu.**

**Signature of the Participant**

**Date : 28/12/2018**



# CENTRE FOR FACULTY DEVELOPMENT

Anna University, Chennai-600025.

## FACULTY DEVELOPMENT TRAINING PROGRAMME - Winter Vacation-2018

### FEEDBACK FORM

|   |   |
|---|---|
| Title of the Programme<br><b>Distributed System</b> | Duration<br><b>15.12.18 to 28.12.18</b> |
|---|---|

|  |
|--|
| 1. Name & Designation<br><b>K. Manikanda Kumaran</b>                       |
| 2. Name of the College<br><b>E.G.S. Pillay Engg. College,</b>              |
| 3. No. of Resource Persons<br>Internal <b>1</b> <b>8</b> External <b>8</b> |

4. Comments about the following : (Please tick the relevant box e.g. 5 - highest, 1 - lowest)

|  |                                    |                                    |                         |                         |                         |
|--|------------------------------------|------------------------------------|-------------------------|-------------------------|-------------------------|
| i. Subject content   | <input type="radio"/> 5            | <input checked="" type="radio"/> 4 | <input type="radio"/> 3 | <input type="radio"/> 2 | <input type="radio"/> 1 |
| ii. Coverage of syllabus                                       | <input checked="" type="radio"/> 5 | <input type="radio"/> 4            | <input type="radio"/> 3 | <input type="radio"/> 2 | <input type="radio"/> 1 |
| iii. Technical Presentation by Internal Faculty                | <input checked="" type="radio"/> 5 | <input type="radio"/> 4            | <input type="radio"/> 3 | <input type="radio"/> 2 | <input type="radio"/> 1 |
| iv. Technical Presentation by External Faculty                 | <input checked="" type="radio"/> 5 | <input type="radio"/> 4            | <input type="radio"/> 3 | <input type="radio"/> 2 | <input type="radio"/> 1 |
| v. Course Materials Supplied                                   | <input type="radio"/> 5            | <input checked="" type="radio"/> 4 | <input type="radio"/> 3 | <input type="radio"/> 2 | <input type="radio"/> 1 |
| vi. Tutorials  | <input type="radio"/> 5            | <input checked="" type="radio"/> 4 | <input type="radio"/> 3 | <input type="radio"/> 2 | <input type="radio"/> 1 |
| vii. Laboratory facilities / Site visit                        | <input checked="" type="radio"/> 5 | <input type="radio"/> 4            | <input type="radio"/> 3 | <input type="radio"/> 2 | <input type="radio"/> 1 |
| 5. Level of Excellence and Academic Standards of FDTP.         |                                    |                                    |                         |                         |                         |
| i. Ability to identify, formulate and solve the problems       | <input checked="" type="radio"/> 5 | <input type="radio"/> 4            | <input type="radio"/> 3 | <input type="radio"/> 2 | <input type="radio"/> 1 |
| ii. Ability to use IT techniques and Tools to Deliver Lecturer | <input type="radio"/> 5            | <input checked="" type="radio"/> 4 | <input type="radio"/> 3 | <input type="radio"/> 2 | <input type="radio"/> 1 |
| 6. Developed new skills / improved the ones had already        | <input checked="" type="radio"/> 5 | <input type="radio"/> 4            | <input type="radio"/> 3 | <input type="radio"/> 2 | <input type="radio"/> 1 |
| 7. The example and practical exercises helped to understand    | <input type="radio"/> 5            | <input checked="" type="radio"/> 4 | <input type="radio"/> 3 | <input type="radio"/> 2 | <input type="radio"/> 1 |
| 8. Reception & Hospitality                                     | <input type="radio"/> 5            | <input checked="" type="radio"/> 4 | <input type="radio"/> 3 | <input type="radio"/> 2 | <input type="radio"/> 1 |
| 9. Accommodation & Catering                                    | <input checked="" type="radio"/> 5 | <input type="radio"/> 4            | <input type="radio"/> 3 | <input type="radio"/> 2 | <input type="radio"/> 1 |

11. Opinion / Suggestion / Effectiveness of the course :

ATTESTED

**Dr. S. RAMABALAN, M.E., Ph.D.,**  
PRINCIPAL

Signature of the Participant

Date : **28/12/18**

**E.G.S. Pillay Engineering College,**  
Thethi, Nagore - 611 002.  
Nagapattinam (Dt) Tamil Nadu.

# CENTRE FOR FACULTY DEVELOPMENT

Anna University, Chennai-600025.

FACULTY DEVELOPMENT TRAINING PROGRAMME - Winter Vacation-2018

## FEEDBACK FORM

|   |   |
|---|---|
| Title of the Programme<br><i>Distributed System</i> | Duration<br><i>15.12.18 TO 28.12.18</i> |
|---|---|

1. Name & Designation *A. Hema, Assistant Professor.*

2. Name of the College *E.G.S. Pillay Engineering College (Autonomous)*

3. No. of Resource Persons Internal *8* External *8*

4. Comments about the following : (Please tick the relevant box e.g. 5 - highest, 1 - lowest)

- |   |                                    |                                    |                         |                         |                         |
|---|------------------------------------|------------------------------------|-------------------------|-------------------------|-------------------------|
| i. Subject content                              | <input checked="" type="radio"/> 5 | <input type="radio"/> 4            | <input type="radio"/> 3 | <input type="radio"/> 2 | <input type="radio"/> 1 |
| ii. Coverage of syllabus                        | <input checked="" type="radio"/> 5 | <input type="radio"/> 4            | <input type="radio"/> 3 | <input type="radio"/> 2 | <input type="radio"/> 1 |
| iii. Technical Presentation by Internal Faculty | <input checked="" type="radio"/> 5 | <input type="radio"/> 4            | <input type="radio"/> 3 | <input type="radio"/> 2 | <input type="radio"/> 1 |
| iv. Technical Presentation by External Faculty  | <input checked="" type="radio"/> 5 | <input type="radio"/> 4            | <input type="radio"/> 3 | <input type="radio"/> 2 | <input type="radio"/> 1 |
| v. Course Materials Supplied                    | <input checked="" type="radio"/> 5 | <input type="radio"/> 4            | <input type="radio"/> 3 | <input type="radio"/> 2 | <input type="radio"/> 1 |
| vi. Tutorials                                   | <input type="radio"/> 5            | <input checked="" type="radio"/> 4 | <input type="radio"/> 3 | <input type="radio"/> 2 | <input type="radio"/> 1 |
| vii. Laboratory facilities / Site visit         | <input checked="" type="radio"/> 5 | <input type="radio"/> 4            | <input type="radio"/> 3 | <input type="radio"/> 2 | <input type="radio"/> 1 |

5. Level of Excellence and Academic Standards of FDTP

- |  |                                    |                                    |                         |                         |                         |
|--|------------------------------------|------------------------------------|-------------------------|-------------------------|-------------------------|
| i. Ability to Identify, formulate and solve the problems       | <input type="radio"/> 5            | <input checked="" type="radio"/> 4 | <input type="radio"/> 3 | <input type="radio"/> 2 | <input type="radio"/> 1 |
| ii. Ability to use IT techniques and Tools to Deliver Lecturer | <input checked="" type="radio"/> 5 | <input type="radio"/> 4            | <input type="radio"/> 3 | <input type="radio"/> 2 | <input type="radio"/> 1 |

6. Developed new skills / improved the ones had already  5  4  3  2  1

7. The example and practical exercises helped to understand  5  4  3  2  1

8. Reception & Hospitality  5  4  3  2  1

9. Accommodation & Catering  5  4  3  2  1

11. Opinion / Suggestion / Effectiveness of the course :

*Good*

ATTESTED

*[Signature]*  
**Dr. S. RAMABALAN, M.E., Ph.D.,  
PRINCIPAL**

*[Signature]*  
Signature of the Participant

Date : *28.12.2018*

**E.G.S. Pillay Engineering College,  
Thethi, Nagore - 611 002.  
Nagapattinam (Dt) Tamil Nadu.**



# CENTRE FOR FACULTY DEVELOPMENT

Anna University, Chennai-600025.

**FACULTY DEVELOPMENT TRAINING PROGRAMME - Winter Vacation-2018**

## FEEDBACK FORM

|   |   |
|---|---|
| Title of the Programme<br><div style="font-size: 1.2em; font-family: cursive;">Distributed System</div> | Duration<br>15.12.2018 To<br>28.12.2018 |
|---|---|

|                            |  |          |   |          |   |
|----------------------------|--|----------|---|----------|---|
| 1. Name & Designation      | <div style="font-family: cursive;">N. Lakshya, Assistant Professor</div>   |          |   |          |   |
| 2. Name of the College     | <div style="font-family: cursive;">E.G.S. Pillay Engineering College, (Autonomous)</div>   |          |   |          |   |
| 3. No. of Resource Persons | <table style="width: 100%; border: none;"> <tr> <td style="border: none;">Internal</td> <td style="border: none; text-align: center; font-size: 1.2em;">8</td> <td style="border: none;">External</td> <td style="border: none; text-align: center; font-size: 1.2em;">8</td> </tr> </table> | Internal | 8 | External | 8 |
| Internal                   | 8  | External | 8 |          |   |

4. Comments about the following : (Please tick the relevant box e.g. 5 - highest, 1 - lowest)

|   |  |
|---|--|
| i. Subject content                              | <input checked="" type="radio"/> 5 <input type="radio"/> 4 <input type="radio"/> 3 <input type="radio"/> 2 <input type="radio"/> 1 |
| ii. Coverage of syllabus                        | <input checked="" type="radio"/> 5 <input type="radio"/> 4 <input type="radio"/> 3 <input type="radio"/> 2 <input type="radio"/> 1 |
| iii. Technical Presentation by Internal Faculty | <input checked="" type="radio"/> 5 <input type="radio"/> 4 <input type="radio"/> 3 <input type="radio"/> 2 <input type="radio"/> 1 |
| iv. Technical Presentation by External Faculty  | <input checked="" type="radio"/> 5 <input type="radio"/> 4 <input type="radio"/> 3 <input type="radio"/> 2 <input type="radio"/> 1 |
| v. Course Materials Supplied                    | <input checked="" type="radio"/> 5 <input type="radio"/> 4 <input type="radio"/> 3 <input type="radio"/> 2 <input type="radio"/> 1 |
| vi. Tutorials                                   | <input checked="" type="radio"/> 5 <input type="radio"/> 4 <input type="radio"/> 3 <input type="radio"/> 2 <input type="radio"/> 1 |
| vii. Laboratory facilities / Site visit         | <input type="radio"/> 5 <input checked="" type="radio"/> 4 <input type="radio"/> 3 <input type="radio"/> 2 <input type="radio"/> 1 |

5. Level of Excellence and Academic Standards of FDTP

|  |  |
|--|--|
| i. Ability to Identify, formulate and solve the problems       | <input checked="" type="radio"/> 5 <input type="radio"/> 4 <input type="radio"/> 3 <input type="radio"/> 2 <input type="radio"/> 1 |
| ii. Ability to use IT techniques and Tools to Deliver Lecturer | <input checked="" type="radio"/> 5 <input type="radio"/> 4 <input type="radio"/> 3 <input type="radio"/> 2 <input type="radio"/> 1 |

|   |  |
|---|--|
| 6. Developed new skills / improved the ones had already     | <input checked="" type="radio"/> 5 <input type="radio"/> 4 <input type="radio"/> 3 <input type="radio"/> 2 <input type="radio"/> 1 |
| 7. The example and practical exercises helped to understand | <input checked="" type="radio"/> 5 <input type="radio"/> 4 <input type="radio"/> 3 <input type="radio"/> 2 <input type="radio"/> 1 |
| 8. Reception & Hospitality                                  | <input checked="" type="radio"/> 5 <input type="radio"/> 4 <input type="radio"/> 3 <input type="radio"/> 2 <input type="radio"/> 1 |
| 9. Accommodation & Catering                                 | <input checked="" type="radio"/> 5 <input type="radio"/> 4 <input type="radio"/> 3 <input type="radio"/> 2 <input type="radio"/> 1 |

11. Opinion / Suggestion / Effectiveness of the course :

Overall, Seminar is Good.

ATTESTED

DR.S.RAMABALAN, M.E., Ph.D.,  
PRINCIPAL

E.G.S. Pillay Engineering College,  
Thethi, Nagore - 611 002.  
Nagapattinam (Dt) Tanj.

|                              |
|------------------------------|
|                              |
| Signature of the Participant |
| Date : 28/12/18              |

# CENTRE FOR FACULTY DEVELOPMENT

Anna University, Chennai-600025.

## FACULTY DEVELOPMENT TRAINING PROGRAMME - Winter Vacation-2018

### FEEDBACK FORM

|  |  |
|--|--|
| Title of the Programme<br>CS6601 - Distributed Systems | Duration<br>14 days<br>(15/12/18) - (28/12/18) |
|--|--|

1. Name & Designation GOKILA. R. G, Asst. Professor

2. Name of the College E.G.S Pillay Engineering College

3. No. of Resource Persons Internal 8 External 8

4. Comments about the following : (Please tick the relevant box e.g. 5 - highest, 1 - lowest)

|   |                                    |                         |                         |                         |                         |
|---|------------------------------------|-------------------------|-------------------------|-------------------------|-------------------------|
| i. Subject content                              | <input checked="" type="radio"/> 5 | <input type="radio"/> 4 | <input type="radio"/> 3 | <input type="radio"/> 2 | <input type="radio"/> 1 |
| ii. Coverage of syllabus                        | <input checked="" type="radio"/> 5 | <input type="radio"/> 4 | <input type="radio"/> 3 | <input type="radio"/> 2 | <input type="radio"/> 1 |
| iii. Technical Presentation by Internal Faculty | <input checked="" type="radio"/> 5 | <input type="radio"/> 4 | <input type="radio"/> 3 | <input type="radio"/> 2 | <input type="radio"/> 1 |
| iv. Technical Presentation by External Faculty  | <input checked="" type="radio"/> 5 | <input type="radio"/> 4 | <input type="radio"/> 3 | <input type="radio"/> 2 | <input type="radio"/> 1 |
| v. Course Materials Supplied                    | <input checked="" type="radio"/> 5 | <input type="radio"/> 4 | <input type="radio"/> 3 | <input type="radio"/> 2 | <input type="radio"/> 1 |
| vi. Tutorials                                   | <input checked="" type="radio"/> 5 | <input type="radio"/> 4 | <input type="radio"/> 3 | <input type="radio"/> 2 | <input type="radio"/> 1 |
| vii. Laboratory facilities / Site visit         | <input checked="" type="radio"/> 5 | <input type="radio"/> 4 | <input type="radio"/> 3 | <input type="radio"/> 2 | <input type="radio"/> 1 |

5. Level of Excellence and Academic Standards of FDTP

|  |                                    |                                    |                         |                         |                         |
|--|------------------------------------|------------------------------------|-------------------------|-------------------------|-------------------------|
| i. Ability to Identify, formulate and solve the problems       | <input type="radio"/> 5            | <input checked="" type="radio"/> 4 | <input type="radio"/> 3 | <input type="radio"/> 2 | <input type="radio"/> 1 |
| ii. Ability to use IT techniques and Tools to Deliver Lecturer | <input checked="" type="radio"/> 5 | <input type="radio"/> 4            | <input type="radio"/> 3 | <input type="radio"/> 2 | <input type="radio"/> 1 |

6. Developed new skills / improved the ones had already  5  4  3  2  1

7. The example and practical exercises helped to understand  5  4  3  2  1

8. Reception & Hospitality  5  4  3  2  1

9. Accommodation & Catering  5  4  3  2  1

11. Opinion / Suggestion / Effectiveness of the course :  
More Informative Sessions  
**ATTESTED**  
  
**Dr. S. RAMABALAN, M.E., Ph.D.**

R. L. L. T  
Signature of the Participant  
Date : 28/12/18



# CENTRE FOR FACULTY DEVELOPMENT

Anna University, Chennai-600025.

## FACULTY DEVELOPMENT TRAINING PROGRAMME - Winter Vacation-2018

### FEEDBACK FORM

Title of the Programme

Distributed Systems

Duration

15-12-18 to 20-2-18

1. Name & Designation

S. Palani Murugan, Assistant Professor / CSE

2. Name of the College

E.G.S. Pillay Engineering College, Nagapattinam.

3. No. of Resource Persons

Internal 8

External 8

4. Comments about the following : (Please tick the relevant box e.g. 5 - highest, 1 - lowest)

i. Subject content

5 4 3 2 1

ii. Coverage of syllabus

5 4 3 2 1

iii. Technical Presentation by Internal Faculty

6 4 3 2 1

iv. Technical Presentation by External Faculty

5 4 3 2 1

v. Course Materials Supplied

5 4 3 2 1

vi. Tutorials

5 4 3 2 1

vii. Laboratory facilities / Site visit

5 4 3 2 1

5. Level of Excellence and Academic Standards of FDTP

i. Ability to Identify, formulate and solve the problems

5 4 3 2 1

ii. Ability to use IT techniques and Tools to Deliver Lecturer

5 4 3 2 1

6. Developed new skills / improved the ones had already

5 4 3 2 1

7. The example and practical exercises helped to understand

5 4 3 2 1

8. Reception & Hospitality

5 4 3 2 1

9. Accommodation & Catering

5 4 3 2 1

11. Opinion / Suggestion / Effectiveness of the course :

Conducted well.

ATTESTED

Dr. S. RAMABALAN, M.E., Ph.D.,  
PRINCIPAL

E.G.S. Pillay Engineering College.

Thethi, Nagore - 611 002.

Nagapattinam (Dt) Tamil Nadu.

Signature of the Participant

Date 20-12-2018

# CENTRE FOR FACULTY DEVELOPMENT

Anna University, Chennai-600025.

## FACULTY DEVELOPMENT TRAINING PROGRAMME - Winter Vacation-2018

### FEEDBACK FORM

|  |                                 |
|--|---------------------------------|
| Title of the Programme<br>FDTP on CS6601 - Distributed Systems | Duration<br>15/12/18 - 28/12/18 |
|--|---------------------------------|

1. Name & Designation **G. ARUL SELVAN ASSISTANT PROFESSOR**

2. Name of the College **E.G.S. Pillay Engineering College**

3. No. of Resource Persons Internal **8** External **8**

4. Comments about the following : (Please tick the relevant box e.g. 5 - highest, 1 - lowest)

- |   |                                    |                                    |                         |                         |                         |
|---|------------------------------------|------------------------------------|-------------------------|-------------------------|-------------------------|
| i. Subject content                              | <input checked="" type="radio"/> 5 | <input type="radio"/> 4            | <input type="radio"/> 3 | <input type="radio"/> 2 | <input type="radio"/> 1 |
| ii. Coverage of syllabus                        | <input type="radio"/> 5            | <input checked="" type="radio"/> 4 | <input type="radio"/> 3 | <input type="radio"/> 2 | <input type="radio"/> 1 |
| iii. Technical Presentation by Internal Faculty | <input type="radio"/> 5            | <input checked="" type="radio"/> 4 | <input type="radio"/> 3 | <input type="radio"/> 2 | <input type="radio"/> 1 |
| iv. Technical Presentation by External Faculty  | <input type="radio"/> 5            | <input checked="" type="radio"/> 4 | <input type="radio"/> 3 | <input type="radio"/> 2 | <input type="radio"/> 1 |
| v. Course Materials Supplied                    | <input type="radio"/> 5            | <input checked="" type="radio"/> 4 | <input type="radio"/> 3 | <input type="radio"/> 2 | <input type="radio"/> 1 |
| vi. Tutorials                                   | <input checked="" type="radio"/> 5 | <input type="radio"/> 4            | <input type="radio"/> 3 | <input type="radio"/> 2 | <input type="radio"/> 1 |
| vii. Laboratory facilities / Site visit         | <input checked="" type="radio"/> 5 | <input type="radio"/> 4            | <input type="radio"/> 3 | <input type="radio"/> 2 | <input type="radio"/> 1 |

5. Level of Excellence and Academic Standards of FDTP

- |  |                                    |                         |                         |                         |                         |
|--|------------------------------------|-------------------------|-------------------------|-------------------------|-------------------------|
| i. Ability to Identify, formulate and solve the problems       | <input checked="" type="radio"/> 5 | <input type="radio"/> 4 | <input type="radio"/> 3 | <input type="radio"/> 2 | <input type="radio"/> 1 |
| ii. Ability to use IT techniques and Tools to Deliver Lecturer | <input checked="" type="radio"/> 5 | <input type="radio"/> 4 | <input type="radio"/> 3 | <input type="radio"/> 2 | <input type="radio"/> 1 |

6. Developed new skills / improved the ones had already  5  4  3  2  1

7. The example and practical exercises helped to understand  5  4  3  2  1

8. Reception & Hospitality  5  4  3  2  1

9. Accommodation & Catering  5  4  3  2  1

11. Opinion / Suggestion / Effectiveness of the course :

Good

ATTESTED

**Dr. S. RAMABALAN, M.E., Ph.D.,  
PRINCIPAL**

**E.G.S. Pillay Engineering College,**

**Thethi, Nagore - 611 002.**

**Nagapattinam (Dt), Tamil Nadu.**

Signature of the Participant

Date : 28/12/18



# CENTRE FOR FACULTY DEVELOPMENT

Anna University, Chennai-600025.

## FACULTY DEVELOPMENT TRAINING PROGRAMME - Winter Vacation-2018

### FEEDBACK FORM

|   |                            |
|---|----------------------------|
| Title of the Programme<br><b>CS6601- Distributed System</b> | Duration<br><b>2 weeks</b> |
|---|----------------------------|

|   |
|---|
| 1. Name & Designation<br><b>K. BALASUBRAMANIAN, Asso. Prof</b>  |
| 2. Name of the College<br><b>E.G.S. Pillay Engineering College</b>  |
| 3. No. of Resource Persons<br>Internal <input checked="" type="checkbox"/> External <input checked="" type="checkbox"/> |

4. Comments about the following : (Please tick the relevant box e.g. 5 - highest, 1 - lowest)

|   |                                    |                                    |                         |                         |                         |
|---|------------------------------------|------------------------------------|-------------------------|-------------------------|-------------------------|
| i. Subject content                              | <input checked="" type="radio"/> 5 | <input type="radio"/> 4            | <input type="radio"/> 3 | <input type="radio"/> 2 | <input type="radio"/> 1 |
| ii. Coverage of syllabus                        | <input checked="" type="radio"/> 5 | <input type="radio"/> 4            | <input type="radio"/> 3 | <input type="radio"/> 2 | <input type="radio"/> 1 |
| iii. Technical Presentation by Internal Faculty | <input type="radio"/> 5            | <input checked="" type="radio"/> 4 | <input type="radio"/> 3 | <input type="radio"/> 2 | <input type="radio"/> 1 |
| iv. Technical Presentation by External Faculty  | <input checked="" type="radio"/> 5 | <input type="radio"/> 4            | <input type="radio"/> 3 | <input type="radio"/> 2 | <input type="radio"/> 1 |
| v. Course Materials Supplied                    | <input checked="" type="radio"/> 5 | <input type="radio"/> 4            | <input type="radio"/> 3 | <input type="radio"/> 2 | <input type="radio"/> 1 |
| vi. Tutorials                                   | <input type="radio"/> 5            | <input checked="" type="radio"/> 4 | <input type="radio"/> 3 | <input type="radio"/> 2 | <input type="radio"/> 1 |
| vii. Laboratory facilities / Site visit         | <input checked="" type="radio"/> 5 | <input type="radio"/> 4            | <input type="radio"/> 3 | <input type="radio"/> 2 | <input type="radio"/> 1 |

5. Level of Excellence and Academic Standards of FDTP

|  |                                    |                         |                         |                         |                         |
|--|------------------------------------|-------------------------|-------------------------|-------------------------|-------------------------|
| i. Ability to Identify, formulate and solve the problems       | <input checked="" type="radio"/> 5 | <input type="radio"/> 4 | <input type="radio"/> 3 | <input type="radio"/> 2 | <input type="radio"/> 1 |
| ii. Ability to use IT techniques and Tools to Deliver Lecturer | <input checked="" type="radio"/> 5 | <input type="radio"/> 4 | <input type="radio"/> 3 | <input type="radio"/> 2 | <input type="radio"/> 1 |
| 6. Developed new skills / improved the ones had already        | <input checked="" type="radio"/> 5 | <input type="radio"/> 4 | <input type="radio"/> 3 | <input type="radio"/> 2 | <input type="radio"/> 1 |
| 7. The example and practical exercises helped to understand    | <input checked="" type="radio"/> 5 | <input type="radio"/> 4 | <input type="radio"/> 3 | <input type="radio"/> 2 | <input type="radio"/> 1 |
| 8. Reception & Hospitality                                     | <input checked="" type="radio"/> 5 | <input type="radio"/> 4 | <input type="radio"/> 3 | <input type="radio"/> 2 | <input type="radio"/> 1 |
| 9. Accommodation & Catering                                    | <input checked="" type="radio"/> 5 | <input type="radio"/> 4 | <input type="radio"/> 3 | <input type="radio"/> 2 | <input type="radio"/> 1 |

11. Opinion / Suggestion / Effectiveness of the course :

ATTESTED

**Dr. S. RAMABALAN, M.E., Ph.D.,**  
PRINCIPAL

E.G.S. Pillay Engineering College,  
Thethi, Nagore - 611 002.  
Nagapattinam (Dt) Tamil Nadu.

**K. Balasubramanian**  
Signature of the Participant

Date : **28-12-18**

**Two-Week Faculty Development Training Programme (Winter 2018)**  
**On**  
**CS6601- DISTRIBUTED SYSTEMS**  
**15-12-2018 to 28-12-2018**



**ATTESTED**  
  
**Dr. S. RAMABALAN, M.E., Ph.D.,**  
**PRINCIPAL**  
**E.G.S. Pillay Engineering College.**



**Two-Week Faculty Development Training Programme (Winter 2018)**  
**On**  
**CS6601- DISTRIBUTED SYSTEMS**  
**15-12-2018 to 28-12-2018**

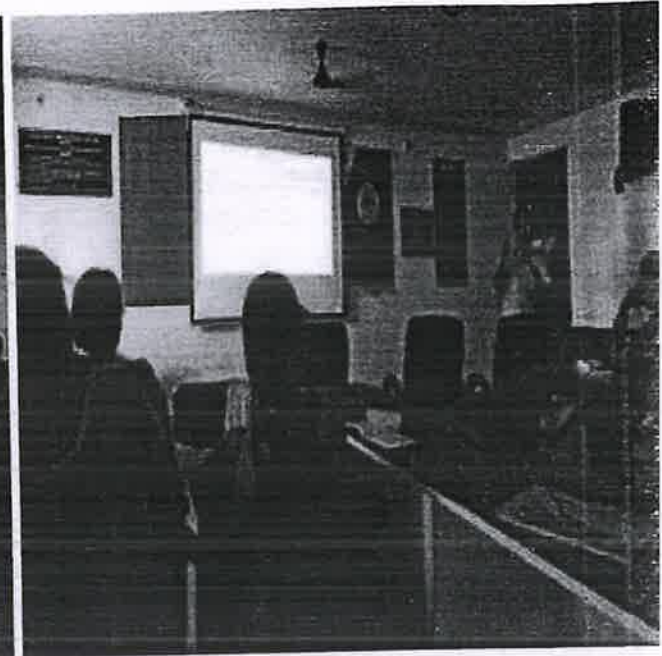
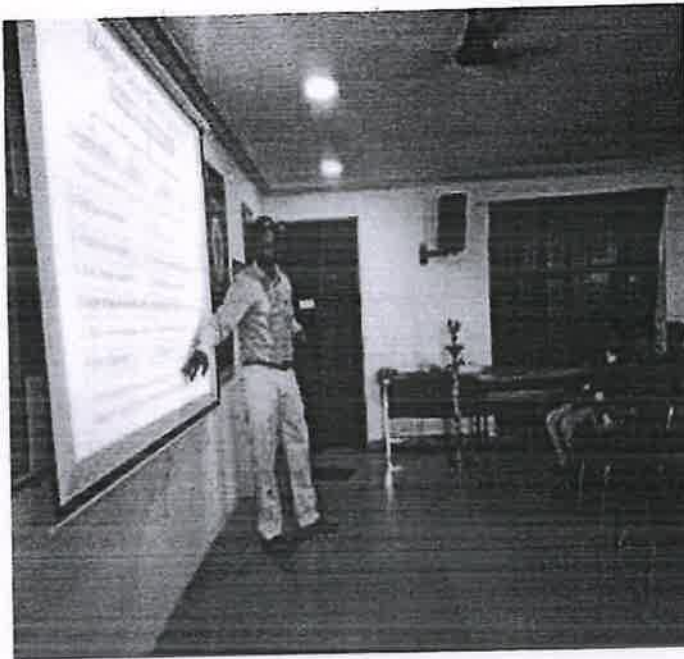

ATTESTED

**Dr. S. RAMABALAN, M.E., Ph.D.,**  
**PRINCIPAL**

**E.G.S. Pillay Engineering College,**  
**Thethi, Nagore - 611 002.**

**N. Pattinani (Dt) Tamil Nadu.**

**E. G.S.PILLAY ENGINEERING COLLEGE  
(Autonomous)**

NAGAPATTINAM - 611 002.

(An ISO 9001:2008 Certified Institution)

(Approved by AICTE, New Delhi, Approved by Govt. of Tamil Nadu )

(Affiliated to Anna University Chennai)

(Accredited by NAAC with 'A' Grade)

(NBA Accredited Programmes B.E - CSE,EEE & Mechanical))



**DEPARTMENT OF COMPUTER SCIENCE AND ENGINEERING  
DEPARTMENT OF MASTER OF COMPUTER APPLICATIONS**

19.01.2019

To

The Director,  
Centre for Faculty Development,  
Anna University,  
Chennai-25.

Respected Sir,

Sub: FDTP-Winter 2018- rescheduling FDTP dates-reg.

Ref: Letter No.27/CFD/Winter/Self Finance/2018-29, Dated 01-11-2018.

\*\*\*\*\*

We would like to bring to your kind attention that we had applied for FDTP Self Supporting Scheme-winter 2018. We had chosen the title **CS6601- Distributed Systems** which had been approved by you as mentioned in the reference.

We had planned to conduct the FDTP between 26-11-2018 and 09-12-2018 as mentioned in the application. Unexpected weather conditions followed by **Gaja Cyclone**, violently affected our district and therefore we rescheduled the dates of the FDTP between 15-12-2018 and 28-12-2018.

We have successfully conducted the FDTP programme and submitted the documents. Kindly permit and accept the rescheduled dates of the FDTP. Please do needful.

Thank you for consideration.

Name & Signature of Coordinators

1. Dr. A. S. Anakath

2. Prof. M. Rajakumaran



Principal

**Dr. S. RAMABALAN, M.E., Ph.D.,**  
Principal  
E.G.S. Pillay Engineering College,  
Nagapattinam - 611 002.

Email: hodcse@egspec.org

Personal : +91-9965128581

Web site : www.egspec.org

ATTESTED 373067032

**Dr. S. RAMABALAN, M.E., Ph.D.,**  
PRINCIPAL  
E.G.S. Pillay Engineering College,  
Thethi, Nagore - 611 002.



# CENTRE FOR FACULTY DEVELOPMENT

Anna University, Chennai-600025.

FACULTY DEVELOPMENT TRAINING PROGRAMME - Winter Vacation-2018

## DECLARATION FORM

Dr. / ~~Mr.~~ / ~~Mrs.~~ / ~~Ms~~ ..... A.S. ANAKATH .....

working as Professor ..... in the college of E.G.S. Pillay

Engineering College, Nagapattinam .....

hereby declare that I have coordinated the FDTP on CS6601- Distributed Systems

held at E.G.S. Pillay Engineering College .....

during the period from 15-12-2018 to 28-12-2018 .....

I also confirm that in the above mentioned period I am not involved in any other  
official work.

ASA 19/01/2019  
Signature of the Co-ordinator with date

ATTESTED

Dr. S. RAMABALAN, M.E., Ph.D.,  
PRINCIPAL

E.G.S. Pillay Engineering College,  
Thethi, Nagore - 611 002.  
Nagapattinam (Dt) Tamil Nadu.

# CENTRE FOR FACULTY DEVELOPMENT

Anna University, Chennai-600025.

FACULTY DEVELOPMENT TRAINING PROGRAMME - Winter Vacation-2018

## DECLARATION FORM

Dr. / Mr. / Mrs. / Ms ..... M. RAJAKUMARAN .....

working as ASST. PROF. ..... in the college of E. G. S. Pillay .....

Engineering ..... College, Nagapattinam .....

hereby declare that I have coordinated the FDTP on CS6601 - Distributed Systems

held at E. G. S. Pillay Engineering College, Nagapattinam .....

during the period from 15/12/18 ..... to 28/12/18 .....

I also confirm that in the above mentioned period I am not involved in any other  
official work.

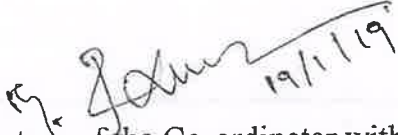
  
Signature of the Co-ordinator with date

ATTESTED

  
Dr. S. RAMABALAN, M.E., Ph.D.,  
PRINCIPAL

E.G.S. Pillay Engineering College,

Thethi Nagar - 611 002

Nagapattinam (T), Tamil Nadu.

**REGISTRATION FORM**

Name :  
Designation :  
Qualification :  
E-mail :  
Mobile no. :  
DOB and Age :  
Institution address :  
Communication address :

I declare that I am willing to attend this FDTP programme on CS6601– Distributed System from 15th Dec - 28th Dec 2018.

I declare that the details furnished above are true to the best of my knowledge and belief and agreed to abide by the rules and regulations governing the conduct of faculty development training program sponsored by Centre for Faculty Development Anna University, Chennai.

**Signature of Applicant**

Date :

Place:

**ATTESTED**  
  
**Dr. S. RAMABALAN, M.E., Ph.D.,**  
**PRINCIPAL**  
**E.G.S. Pillay Engineering College,**  
**Thethi, Nagore - 611 001,**  
**Nagapattinam (Dt) Tamil Nadu.**

# CENTRE FOR FACULTY DEVELOPMENT

Anna University, Chennai-600025.

**FACULTY DEVELOPMENT TRAINING PROGRAMME - Winter Vacation-2018**

## DECLARATION FORM

Dr. / Mr. / Mrs. / Ms. ....

working as.....in the college of .....

hereby declare that I have attended the FDTP on .....

held at .....

during the period from ..... to.....

**I also confirm that in the above mentioned period I am not involved in any other official work.**

Signature of the Participant with date

**ATTESTED**

  
**Dr. S. RAMABALAN, M.E., Ph.D.,**  
**PRINCIPAL**

**E.G.S. Pillay Engineering College,**  
**Thethi, Nagore - 611 004,**  
**Nagapattinam (Dt) Tamil Nadu.**



# CENTRE FOR FACULTY DEVELOPMENT

Anna University, Chennai-600025.

## FACULTY DEVELOPMENT TRAINING PROGRAMME - Winter Vacation-2018

### FEEDBACK FORM

|                        |          |
|------------------------|----------|
| Title of the Programme | Duration |
|------------------------|----------|

1. Name & Designation

2. Name of the College

3. No. of Resource Persons 

|          |          |
|----------|----------|
| Internal | External |
|----------|----------|

4. Comments about the following : (Please tick the relevant box e.g. 5 - highest, 1 - lowest)

i. Subject content 

|   |   |   |   |   |
|---|---|---|---|---|
| 5 | 4 | 3 | 2 | 1 |
|---|---|---|---|---|

ii. Coverage of syllabus 

|   |   |   |   |   |
|---|---|---|---|---|
| 5 | 4 | 3 | 2 | 1 |
|---|---|---|---|---|

iii. Technical Presentation by Internal Faculty 

|   |   |   |   |   |
|---|---|---|---|---|
| 5 | 4 | 3 | 2 | 1 |
|---|---|---|---|---|

iv. Technical Presentation by External Faculty 

|   |   |   |   |   |
|---|---|---|---|---|
| 5 | 4 | 3 | 2 | 1 |
|---|---|---|---|---|

v. Course Materials Supplied 

|   |   |   |   |   |
|---|---|---|---|---|
| 5 | 4 | 3 | 2 | 1 |
|---|---|---|---|---|

vi. Tutorials 

|   |   |   |   |   |
|---|---|---|---|---|
| 5 | 4 | 3 | 2 | 1 |
|---|---|---|---|---|

vii. Laboratory facilities / Site visit 

|   |   |   |   |   |
|---|---|---|---|---|
| 5 | 4 | 3 | 2 | 1 |
|---|---|---|---|---|

5. Level of Excellence and Academic Standards of FDTP

i. Ability to Identify, formulate and solve the problems 

|   |   |   |   |   |
|---|---|---|---|---|
| 5 | 4 | 3 | 2 | 1 |
|---|---|---|---|---|

ii. Ability to use IT techniques and Tools to Deliver Lecturer 

|   |   |   |   |   |
|---|---|---|---|---|
| 5 | 4 | 3 | 2 | 1 |
|---|---|---|---|---|

6. Developed new skills / improved the ones had already 

|   |   |   |   |   |
|---|---|---|---|---|
| 5 | 4 | 3 | 2 | 1 |
|---|---|---|---|---|

7. The example and practical exercises helped to understand 

|   |   |   |   |   |
|---|---|---|---|---|
| 5 | 4 | 3 | 2 | 1 |
|---|---|---|---|---|

8. Reception & Hospitality 

|   |   |   |   |   |
|---|---|---|---|---|
| 5 | 4 | 3 | 2 | 1 |
|---|---|---|---|---|

9. Accommodation & Catering 

|   |   |   |   |   |
|---|---|---|---|---|
| 5 | 4 | 3 | 2 | 1 |
|---|---|---|---|---|

11. Opinion / Suggestion / Effectiveness of the course :

**ATTESTED**  
  
**Dr. S. RAMABALAN, M.E., PH.D.,**  
**PRINCIPAL**  
**E.G.S. Pillay Engineering College,**  
Thethi, Nagore - 611 000  
Nagapattinam (Dt) Tanj.

|                              |
|------------------------------|
| Signature of the Participant |
| Date :                       |

**APPLICATION FOR  
FACULTY DEVELOPMENT TRAINING PROGRAMME (FDTP)**

**SUBMITTED TO  
CENTRE FOR FACULTY DEVELOPMENT  
ANNA UNIVERSITY - CHENNAI**

*COURSE*  
CS6601 – DISTRIBUTED SYSTEMS

*Submitted by*

*Dr.A.S.Anakath, M.E., Ph.D*  
*Prof.M. Rajakumaran, M.E.,(Ph.D)*



**E.G.S.PILLAY ENGINEERING COLLEGE  
[AUTONOMOUS]**

**NAGAPATTINAM – TAMIL NADU - INDIA  
APPROVED BY AICTE. AFFILIATED TO ANNA UNIVERSITY  
ACCREDITED BY NAAC WITH 'A' GRADE**

**DEPARTMENT OF COMPUTER SCIENCE AND ENGINEERING**

**ATTESTED**

  
**Dr. S. RAMABALAN, M.E., Ph.D.,  
PRINCIPAL**

**E.G.S. Pillay Engineering College,  
Thethi, Nagore - 611 002.**



**E. G. S. PILLAY ENGINEERING COLLEGE  
(Autonomous)**

NAGAPATTINAM - 611 002.

(An ISO 9001:2008 Certified Institution)  
(Approved by AICTE, New Delhi, Approved by Govt. of Tamil Nadu )  
(Affiliated to Anna University Chennai)  
(Accredited by NAAC with 'A' Grade)  
(NBA Accredited Programmes B.E - CSE, EEE & Mechanical))



**DEPARTMENT OF COMPUTER SCIENCE AND ENGINEERING**

25.10.2018

To

The Director  
Centre for Faculty Development  
Anna University  
Chennai-25

Respected Sir,

Sub : Proposal – FDTP – Winter - 2018 – reg.

We are writing you concerning a FDTP Self Supporting Scheme opportunity with the winter 2018, Faculty Development Training Programme.

We know that Anna University, Centre for Faculty Development has as its mission a desire to give back to the community of teaching faculties of various affiliated colleges. We had chosen the title the CS6601- Distributed Systems which place a major role in our field. We are anxiously looking forward your support to conduct FDTP in December 2018..

We would be grateful if you help in FDTP Self Supporting us. We assure you we will conduct this programme in commendable manner and awaits favorable reply.

Thank you for consideration.

Sincerely,

1. Dr.A.S.Anakath

2. Prof. M.Rajakumaran -

**ATTESTED**

**Dr. S. RAMABALAN, M.E., Ph.D.,  
PRINCIPAL**

**E.G.S. Pillay Engineering College,**

(Coordinator(s))

**REGISTRATION FORM - TWO-WEEK FDTP - WINTER 2018**

CENTRE FOR FACULTY DEVELOPMENT

ANNA UNIVERSITY, CHENNAI - 25

|  |                                    |   |                         |
|--|------------------------------------|---|-------------------------|
| <i>3806 E.G.S. Pillay Engineering College</i><br>Estb.1995 |                                    |   |                         |
| B.E.<br>CSE<br>VI<br>(Regulations<br>2013)                 | CS6601 -<br>Distributed<br>Systems | 1. Dr. A. S. Anakath,<br>Prof., 2. M.<br>Rajakumaran, Asst. Prof. | 11/26/2018<br>12/9/2018 |

**1. PROFILE OF THE CO-ORDINATOR(S) :** (with qualification and experience)

To be enclosed as Annexure - I

**2. Details of FDTP conducted in the last 5 years:** (following format)

To be enclosed as Annexure - II

| Year | Department | Subject code | Subject Name | Total Amount Sanctioned by<br>CFD, AU |
|------|------------|--------------|--------------|---------------------------------------|
|      |            |              |              |                                       |

**3. PROFILE OF THE FACULTY IDENTIFIED**

(With qualification, designation, No. of years in teaching experience in the relevant subject)

Internal Faculty in Annexure - III

External Faculty in Annexure - IV

**4. SCHEDULE OF TRAINING PROGRAMME** To be enclosed as Annexure - V

a. Subject Name, Code No, Branch and the Semester to be indicated.

b. Furnish the time table with details of theory classes, tutorials, assignments, etc.

**5. DECLARATION: We hereby agree to conduct the FDTP Winter 2018 as a  
Self - supporting programme.**

*Anakath*  
Signature of the Co-ordinator

*MCh*  
Signature of the HOD  
Dr. M. CHINNADURAI, M.E., Ph.D.,  
Professor & Head

*Ramabalan*  
Signature of the Principal  
with seal

Contact No: 9486433704

Department of CSE  
E.G.S. Pillay Engineering College,  
Nagapattinam - 611 002.

**PRINCIPAL**  
E.G.S. Pillay Engineering College,  
Nagapattinam.

**ATTESTED**

*Ramabalan*  
Dr. S. RAMABALAN, M.E., Ph.D.  
**PRINCIPAL**

Note: Principals are advised to forward a maximum of 3 proposals only from your college.

E.G.S. Pillay Engineering College,  
Thethi, Nagore - 5  
Nagapattinam (Dt) T.



**FEEDBACK FORM ANALYSIS REPORT**

| S. NO | PARTICIPATION NAME                               | Subject Content | Coverage of Syllabus | Technical Presentation by Internal Faculty | Technical Presentation by external Faculty | Course Materials supplied | Tutorials | Laboratory facilities / Site visit | Formulate and Solve the problems | Use IT techniques and Tools to deliver lecturer | Developing new skills | Practical excersises helped to understand | Reception and Hospitality | Accomadation and Catering |
|-------|--|-----------------|----------------------|--|--|---------------------------|-----------|------------------------------------|----------------------------------|---|-----------------------|---|---------------------------|---------------------------|
| 1     | MG. Kavitha                                      | 5               | 5                    | 5  | 5  | 5                         | 5         | 5                                  | 5                                | 5   | 5                     | 5   | 5                         | 5                         |
| 2     | B. Rajesh  | 4               | 5                    | 5  | 5  | 4                         | 4         | 4                                  | 4                                | 5   | 5                     | 4   | 5                         | 5                         |
| 3     | S. Senthilkumar                                  | 5               | 5                    | 4  | 5  | 4                         | 5         | 4                                  | 4                                | 4   | 4                     | 5   | 5                         | 5                         |
| 4     | K. Preethi                                       | 5               | 5                    | 5  | 5  | 5                         | 5         | 5                                  | 5                                | 5   | 5                     | 5   | 5                         | 5                         |
| 5     | N. Kavitha                                       | 5               | 5                    | 4  | 4  | 4                         | 4         | 5                                  | 4                                | 4   | 3                     | 5   | 5                         | 5                         |
| 6     | E. Saranya                                       | 5               | 5                    | 4  | 4  | 4                         | 5         | 5                                  | 4                                | 4   | 4                     | 4   | 5                         | 5                         |
| 7     | A. Indiradevi                                    | 4               | 5                    | 5  | 5  | 4                         | 5         | 5                                  | 4                                | 4   | 5                     | 4   | 5                         | 5                         |
| 8     | G. Saranya                                       | 5               | 5                    | 4  | 4  | 4                         | 5         | 4                                  | 4                                | 4   | 5                     | 4   | 5                         | 4                         |
| 9     | M. Mohamed Faisal                                | 5               | 5                    | 5  | 5  | 5                         | 5         | 5                                  | 5                                | 4   | 4                     | 5   | 5                         | 5                         |
| 10    | M. Vengateshwaran                                | 5               | 5                    | 5  | 5  | 4                         | 4         | 5                                  | 4                                | 5   | 4                     | 4   | 3                         | 4                         |
| 11    | V. Sathya  | 5               | 5                    | 4  | 5  | 5                         | 4         | 5                                  | 5                                | 5   | 5                     | 5   | 5                         | 4                         |
| 12    | BN. Karthik                                      | 5               | 5                    | 4  | 5  | 4                         | 5         | 5                                  | 5                                | 5   | 5                     | 5   | 5                         | 5                         |
| 13    | S. RAMARAJAN, M.E., Ph.D.,<br>PRINCIPAL          | 5               | 4                    | 5  | 4  | 5                         | 5         | 5                                  | 5                                | 5   | 5                     | 5   | 5                         | 5                         |
| 14    | C. Palanisamy<br>Principal, Engineering College, | 4               | 4                    | 5  | 3  | 5                         | 4         | 5                                  | 5                                | 4   | 4                     | 5   | 5                         | 5                         |
| 15    | M. Kiruthika Devi, 611 002                       | 4               | 4                    | 4  | 3  | 5                         | 5         | 5                                  | 4                                | 4   | 4                     | 5   | 5                         | 5                         |

Nayagapattinam (Dt) Tamil Nadu.

|                               |                     |             |            |             |             |             |             |            |             |             |             |             |             |             |             |
|-------------------------------|---------------------|-------------|------------|-------------|-------------|-------------|-------------|------------|-------------|-------------|-------------|-------------|-------------|-------------|-------------|
| 16                            | VTA. Anitha         | 4           | 4          | 5           | 3           | 5           | 5           | 5          | 4           | 4           | 4           | 5           | 5           | 5           | 5           |
| 17                            | D. Infanta Jersy    | 5           | 5          | 3           | 4           | 4           | 0           | 5          | 5           | 4           | 4           | 3           | 5           | 5           | 5           |
| 18                            | M. Anitha           | 5           | 5          | 4           | 5           | 4           | 4           | 4          | 5           | 4           | 5           | 5           | 5           | 5           | 5           |
| 19                            | K. Manikandakumaran | 4           | 5          | 5           | 5           | 4           | 4           | 5          | 5           | 4           | 5           | 4           | 4           | 5           | 5           |
| 20                            | A. Hema             | 5           | 5          | 5           | 5           | 5           | 4           | 5          | 4           | 5           | 5           | 5           | 5           | 5           | 5           |
| 21                            | N. Ilakiya          | 5           | 5          | 5           | 5           | 5           | 5           | 4          | 5           | 5           | 5           | 5           | 5           | 5           | 5           |
| 22                            | RG. Gokila          | 5           | 5          | 5           | 5           | 5           | 5           | 5          | 4           | 5           | 5           | 5           | 5           | 5           | 5           |
| 23                            | S. Palani Murugan   | 5           | 5          | 5           | 4           | 5           | 5           | 5          | 5           | 4           | 5           | 5           | 5           | 5           | 5           |
| 24                            | G. Arulselvan       | 5           | 4          | 4           | 4           | 4           | 5           | 5          | 5           | 4           | 4           | 5           | 5           | 4           | 5           |
| 25                            | K. Balasubramanian  | 5           | 5          | 4           | 5           | 5           | 4           | 5          | 5           | 5           | 5           | 5           | 5           | 5           | 5           |
| <b>Total Credit</b>           |                     | <b>119</b>  | <b>120</b> | <b>113</b>  | <b>112</b>  | <b>113</b>  | <b>111</b>  | <b>120</b> | <b>113</b>  | <b>113</b>  | <b>112</b>  | <b>117</b>  | <b>121</b>  | <b>122</b>  | <b>122</b>  |
| <b>Number of Participants</b> |                     | <b>25</b>   |            |             |             |             |             |            |             |             |             |             |             |             |             |
| <b>Average</b>                |                     | <b>4.76</b> | <b>4.8</b> | <b>4.52</b> | <b>4.48</b> | <b>4.52</b> | <b>4.44</b> | <b>4.8</b> | <b>4.52</b> | <b>4.52</b> | <b>4.48</b> | <b>4.68</b> | <b>4.84</b> | <b>4.88</b> | <b>4.88</b> |

Overall Attainment 4.63

Target Attainment 2.5

Target Attainment is achieved

  
Faculty Incharge

  
HOD/CSE

**ATTESTED**  
  
**Dr. S. RAMABALAN, M.E., Ph.D.,**  
**PRINCIPAL**  
E.G.S. Pillay Engineering College,  
Theethi, Nagore - 611 302,  
Nagapattinam (Dist) Thanjavur.



## **E.G.S. PILLAY ENGINEERING COLLEGE**

(An Autonomous Institution, Affiliated to Anna University, Chennai)  
Nagore Post, Nagapattinam – 611 002, Tamilnadu.

## **DEPARTMENT OF CIVIL ENGINEERING**



## **Precious Enlightening Association of Civil Engineering (PEACE)**

Organized

## **One Day Training Program on Laboratory Safety Test Procedure**

20/12/2018

**ATTESTED**

**Dr. S. RAMABALAN, M.E., Ph.D.,  
PRINCIPAL**

**E.G.S. Pillay Engineering College,  
Thethi, Nagore - 611 002.  
Nagapattinam (Dt) Tamil Nadu.**



# E.G.S. PILLAY ENGINEERING COLLEGE

(An Autonomous Institution, Affiliated to Anna University, Chennai)  
Nagore Post, Nagapattinam – 611 002, Tamilnadu.



## DEPARTMENT OF CIVIL ENGINEERING

### One Day Training Program on Laboratory Safety Test Procedure

| SL.NO | CONTENTS                                    |
|-------|---|
| 1     | Vision, Mission, PEO, PSO AND PO Statements |
| 2     | Summary of the Event                        |
| 3     | Approval Letters & Circulars                |
| 4     | Invitation & Agenda                         |
| 5     | Participants Name List & Attendance         |
| 7     | Sample Photos                               |
| 8     | Feedback Forms                              |
| 9     | Certificate                                 |

ATTESTED

  
Dr. S. RAMABALAN, M.E., Ph.D.,  
PRINCIPAL

E.G.S. Pillay Engineering College,  
Thethi, Nagore - 611 002.  
Nagapattinam (Dt) Tamil Nadu.





# E.G.S. PILLAY ENGINEERING COLLEGE

(An Autonomous Institution, Affiliated to Anna University, Chennai)  
Nagore Post, Nagapattinam – 611 002, Tamilnadu.



## DEPARTMENT OF CIVIL ENGINEERING

### DEPARTMENT VISION

To evolve as a Centre of excellence by imparting quality technical education and promote research to meet the emerging challenges in the field of Civil Engineering.

### DEPARTMENT MISSION

The Civil Engineering department is committed to

- M1:** Provide quality education through innovative teaching and learning practices.
- M2:** Encourage faculty and students to pursue higher education and carry out socially relevant innovative research thereby establishing centers of excellence in emerging areas of research.
- M3:** Offer consultancy services using state-of-the-art facilities fulfilling the needs of industry and society.
- M4:** Enable our students and faculty to play leadership roles in a sustainable manner by adopting professional ethics, entrepreneurship activities, interpersonal skills and a lifelong learning attitude.

### PROGRAMME EDUCATIONAL OBJECTIVES (PEO's)

After successful completion of the programme, Graduates will be able to

- PEO1:** Become a successful Civil Engineer to meet the demand-driven needs in the field of Civil Engineering and related profession or pursue higher study and research or become an entrepreneur.
- PEO2:** Develop core competence by analyzing and design of Civil engineering systems with social awareness and responsibilities.
- PEO3:** Build professionalism, ethical approach, communication skills, and teamwork in their profession and adapt to modern trends by engaging in lifelong learning.

ATTESTED

**Dr. S. RAMABALAN, M.E., Ph.D.,  
PRINCIPAL**

E.G.S. Pillay Engineering College,  
Thethi, Nagore - 611 002.  
Nagapattinam (Dt) Tamil Nadu.

## **PROGRAMME OUTCOMES (POs):**

After successful completion of the programme, Graduates will be able to

- PO1** Application knowledge of mathematics, science, engineering fundamentals
- PO2** Problem Analysis.
- PO3** Design and Development of Solutions
- PO4** Conduct investigations by designing experiments, analysis and interpretation of data and synthesis of information to provide valid conclusions
- PO5** Modern Tool Usage
- PO6** Assessing societal, health, safety, legal and cultural issues
- PO7** Examining Environmental impact and Sustainability
- PO8** Commitment to professional ethics.
- PO9** Function effectively as an individual, and as a member or leader in diverse teams and in multi-disciplinary settings
- PO10** Communicate effectively at oral, written, and presentation level
- PO11** Examine Project Management and Financial aspects
- PO12** Instil Life-long Learning

## **PROGRAMME SPECIFIC OUTCOMES (PSOs):**

After successful completion of the programme, students will be able to

**PSO1:** Analyze the effects of natural calamities like Tsunami, storms, earthquakes, landslides etc. in design of stable structures.

**PSO2:** Use eco-friendly materials and mechanisms for sustainable and life-line infrastructures.

**ATTESTED**

  
**Dr. S. RAMABALAN, M.E., Ph.D.,**  
**PRINCIPAL**  
E.G.S. Pillay Engineering College,  
Thethi, Nagore - 611 002.  
Nagapattinam (Dt) Tamil Nadu.



# E.G.S. PILLAY ENGINEERING COLLEGE

(An Autonomous Institution, Affiliated to Anna University, Chennai)  
Nagore Post, Nagapattinam – 611 002, Tamilnadu.



## DEPARTMENT OF CIVIL ENGINEERING

### One Day Training Program on Laboratory Safety Test Procedure

#### REPORT

The One Day Training Program on **Laboratory Safety Test Procedure** has been conducted for our Non-teaching Faculties and is organized by PEACE association, Department of Civil Engineering, E.G.S. Pillay Engineering College, Nagapattinam. The program was conducted on 20/12/2018. The Program was inaugurated with the welcome address by the event coordinator **Mrs.P.Malliga, Assoc. Prof/Civil.**

Our Head of the Department, **Dr.R.Sivakumar, M.E.,Ph.D.**, gives the special address of the Trainer. **Mr. Ramesh, Manager, Indian Scientific, Mayiladuthurai**, gave a special keynote address and started his session. The participants learned about the handling and maintenance of various equipment. Finally, the session ended with a vote of thanks by **Mr.S.Shyam Sundar, AP/Civil.**

Coordinator

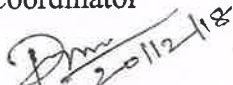
  
(Mrs.P.Malliga)

HoD

  
(Dr.R.Sivakumar)

ATTESTED

  
**Dr. S. RAMABALAN, M.E., Ph.D.,**  
**PRINCIPAL**

**E.G.S. Pillay Engineering College,**  
**Thethi, Nagore - 611 002.**  
**Nagapattinam (Dt) Tamil Nadu.**

**Requisition Letter**

13/12/2018

From

P.Malliga  
Assoc. Prof/Civil,  
E.G.S: Pillay Engineering College,  
Nagapattinam.

To

The Principal,  
E.G.S. Pillay Engineering College,  
Nagapattinam.

Respected Sir,

Sub: Requisition for permission to conduct training program – Reg

We have a plan to organize a One Day Training Program on Laboratory Safety Test Procedure through our PEACE association, Department of Civil Engineering on 20/12/2018. This will be very useful for non-teaching staff to understand the handling and maintenance of equipment in the laboratory. Hence, I request you to kindly permit to conduct the training program.

Thanking you,

Yours faithfully

  
13/12/18  
**P.Malliga**

ATTESTED

  
**Dr. S. RAMABALAN, M.E., Ph.D.,**  
**PRINCIPAL**  
E.G.S. Pillay Engineering College,  
Thethi, Nagore - 611 002.  
Nagapattinam (Dt) Tamil Nadu.





# E.G.S. PILLAY ENGINEERING COLLEGE

(An Autonomous Institution, Affiliated to Anna University, Chennai)  
Nagore Post, Nagapattinam – 611 002, Tamilnadu.



## DEPARTMENT OF CIVIL ENGINEERING

Date: 18/12/2018

### CIRCULAR

## One Day Training Program on Laboratory Safety Test Procedure

We cordially invite you that we are organizing one day Training Program on “Laboratory Safety Test Procedure” dated 20/12/2018, to enhance the knowledge. So, all are asked to participate and make the program a success in grant manner.

Coordinator

  
28/12/18  
(P.Malliga)

HoD

  
(Dr.R.Sivakumar)

Copy to: Principal.

ATTESTED

  
Dr. S. RAMABALAN, M.E., Ph.D.,  
PRINCIPAL

E.G.S. Pillay Engineering College,  
Thethi, Nagore - 611 002.  
Nagapattinam (Dt) Tamil Nadu.



# E.G.S. PILLAY ENGINEERING COLLEGE

(An Autonomous Institution, Affiliated to Anna University, Chennai)  
Nagore Post, Nagapattinam – 611 002, Tamilnadu.



## DEPARTMENT OF CIVIL ENGINEERING

### One Day Training Program on Laboratory Safety Test Procedure

#### Program Schedule (20/12/2018)

| Session                  | Event  |
|--------------------------|--|
| 10.00 a.m. to 10.15 a.m. | <b><u>Inaugural Function:</u></b><br><i>Welcome address:</i><br><b>Mrs.P.Malliga</b><br>Assoc. Prof/Civil.<br><i>Speaker address:</i><br><b>Dr.R.Sivakumar</b><br>Prof & Head, Civil |
| 10.15 a.m. to 10.30 a.m. | <b>Tea Break</b>   |
| 10.30 a.m. to 1.00 p.m.  | <b><u>Session 1</u></b><br><b>Mr. Ramesh,</b><br>Manager,<br>Indian Scientific,<br>Mayiladuthurai  |
| 1.00 p.m. to 2.00 p.m.   | <b>Lunch Break</b>   |
| 2.00 p.m. to 4.00 p.m.   | <b><u>Session 2</u></b><br><b>Mr. Ramesh,</b><br>Manager,<br>Indian Scientific,<br>Mayiladuthurai  |
| 4.00 p.m. to 4.15 p.m.   | <b><u>Vote of thanks:</u></b><br><b>Mr.S.Shyam Sundar,</b><br>AP/Civil.  |

ATTESTED

**Dr. S. RAMABALAN, M.E., Ph.D.,**  
**PRINCIPAL**

E.G.S. Pillay Engineering College,  
Thethi, Nagore - 611 002.  
Nagapattinam (Dt) Tamil Nadu.

**Bio of Mr. Ramesh, Manager, Indian Scientific, Mayiladuthurai**

**Mr. Ramesh** has 30 years of experience in the field of laboratory sales and service. Now he is the Manager of Indian Scientific, Mayiladuthurai.

The Royal Scientific Company started about 20 years back to cater to the field of science they have established itself as a leading company in Tamilnadu. Head Office at Mayiladuthurai with own spacious buildings with the latest infrastructure and a young sales force. They are leading stockists for leading brands of laboratory instruments, chemicals and glasswares (Indian, Imported).

**ATTESTED**

  
**Dr. S. RAMABALAN, M.E., Ph.D.,**  
**PRINCIPAL**

**E.G.S. Pillay Engineering College,**  
**Thethi, Nagore - 611 002.**  
**Nagapattinam (Dt) Tamil Nadu.**



# E.G.S. PILLAY ENGINEERING COLLEGE

(An Autonomous Institution, Affiliated to Anna University, Chennai)

Nagore Post, Nagapattinam – 611 002, Tamilnadu.



## DEPARTMENT OF CIVIL ENGINEERING

### One Day Training Program on Laboratory Safety Test Procedure

#### Participants Name List (20/12/2018)

| S.No | Name          | Department | FN | AN |
|------|---------------|------------|----|----|
| 1.   | V.Rajakumar   | Civil      |    |    |
| 2.   | Durga         | Civil      |    |    |
| 3.   | Sakthivel     | Civil      |    |    |
| 4.   | Ramamoorthy   | Civil      |    |    |
| 5.   | S. Sakthivel  | Mechanical |    |    |
| 6.   | S.Venkatesan  | Mechanical |    |    |
| 7.   | R.Rajasekaran | Mechanical |    |    |
| 8.   | S.Ramamoorthy | Mechanical |    |    |
| 9.   | V.Ramu        | Mechanical |    |    |
| 10.  | S.Joseph      | Mechanical |    |    |

ATTESTED

Dr. S. RAMABALAN, M.E., Ph.D.,  
PRINCIPAL

E.G.S. Pillay Engineering College,  
Thethi, Nagore - 611 002.  
Nagapattinam (Dt) Tamil Nadu.



# E.G.S. PILLAY ENGINEERING COLLEGE, NAGAPATTINAM.

## FEEDBACK FORM

**Name of the Department** : Civil Engineering  
**Nature of the event** : Training Program  
**Title of the Event** : Laboratory Safety Test Procedure  
**Resource Person** : Mr.Ramesh  
**Date** : 20/12/2018  
**Coordinators Name** : P.Malliga

**Ratings have been provided on a 5-point scale**

You strongly disagree with the statement - 1  
 You disagree with the statement - 2  
 You neither agree nor disagree with the statement - 3  
 You agree with the statement - 4  
 You strongly agree with the statement -  5

**About the Content of the Program**

|   |                                     |   |   |   |   |
|---|-------------------------------------|---|---|---|---|
| The Program content was relevant for me           | <input checked="" type="checkbox"/> | 4 | 3 | 2 | 1 |
| The content of the program was very comprehensive | <input checked="" type="checkbox"/> | 4 | 3 | 2 | 1 |
| The content of the program was not repeated       | <input checked="" type="checkbox"/> | 4 | 3 | 2 | 1 |
| The overall content of the program was excellent  | <input checked="" type="checkbox"/> | 4 | 3 | 2 | 1 |

**About Resource person and Presentation**

|  |                                     |                                     |   |   |   |
|--|-------------------------------------|-------------------------------------|---|---|---|
| The speaker had very strong expertise in areas | <input checked="" type="checkbox"/> | 4                                   | 3 | 2 | 1 |
| The speaker had excellent communication skills | 5                                   | <input checked="" type="checkbox"/> | 3 | 2 | 1 |
| The speaker made the program very interesting  | 5                                   | <input checked="" type="checkbox"/> | 3 | 2 | 1 |
| The speaker was very well prepared for program | 5                                   | <input checked="" type="checkbox"/> | 3 | 2 | 1 |

**About the Guest Lecture**

|  |                                     |                                     |   |   |   |
|--|-------------------------------------|-------------------------------------|---|---|---|
| The timings were very convenient                 | <input checked="" type="checkbox"/> | 4                                   | 3 | 2 | 1 |
| The pedagogy used as very appropriate            | 5                                   | <input checked="" type="checkbox"/> | 3 | 2 | 1 |
| There were sufficient breaks in between sessions | <input checked="" type="checkbox"/> | 4                                   | 3 | 2 | 1 |

**Assessment**

|   |                                     |   |   |   |   |
|---|-------------------------------------|---|---|---|---|
| The assessment was very suitable        | <input checked="" type="checkbox"/> | 4 | 3 | 2 | 1 |
| The assessment was not at all difficult | <input checked="" type="checkbox"/> | 4 | 3 | 2 | 1 |

This question is answered on a 10-point scale with 1 being highly unlikely to recommend and 10 being will highly recommend.

Overall Experience      1      2      3      4      5      6      7      8      9       10

Name : S. Venkatesan

Signature : 

**ATTESTED**  
  
**Dr. S. RAMABALAN, M.E., Ph.D.,**  
**PRINCIPAL**  
 E.G.S. Pillay Engineering College,  
 Thethi, Nagore - 611 002.  
 Nagapattinam (Dt) Tamil Nadu.

# E.G.S. PILLAY ENGINEERING COLLEGE, NAGAPATTINAM.

## FEEDBACK FORM

**Name of the Department** : Civil Engineering  
**Nature of the event** : Training Program  
**Title of the Event** : Laboratory Safety Test Procedure  
**Resource Person** : Mr.Ramesh  
**Date** : 20/12/2018  
**Coordinators Name** : P.Malliga

ratings have been provided on a 5-point scale

You strongly disagree with the statement - 1  
 You disagree with the statement - 2  
 You neither agree nor disagree with the statement - 3  
 You agree with the statement - 4  
 You strongly agree with the statement -  5

About the Content of the Program

|   |                                       |   |   |   |   |
|---|---------------------------------------|---|---|---|---|
| The Program content was relevant for me           | <input checked="" type="checkbox"/> 5 | 4 | 3 | 2 | 1 |
| The content of the program was very comprehensive | <input checked="" type="checkbox"/> 5 | 4 | 3 | 2 | 1 |
| The content of the program was not repeated       | <input checked="" type="checkbox"/> 5 | 4 | 3 | 2 | 1 |
| The overall content of the program was excellent  | <input checked="" type="checkbox"/> 5 | 4 | 3 | 2 | 1 |

About Resource person and Presentation

|  |                                       |                                       |   |   |   |
|--|---------------------------------------|---------------------------------------|---|---|---|
| The speaker had very strong expertise in areas | 5                                     | <input checked="" type="checkbox"/> 4 | 3 | 2 | 1 |
| The speaker had excellent communication skills | <input checked="" type="checkbox"/> 5 | 4                                     | 3 | 2 | 1 |
| The speaker made the program very interesting  | 5                                     | <input checked="" type="checkbox"/> 4 | 3 | 2 | 1 |
| The speaker was very well prepared for program | 5                                     | <input checked="" type="checkbox"/> 4 | 3 | 2 | 1 |

About the Guest Lecture

|  |                                       |                                       |   |   |   |
|--|---------------------------------------|---------------------------------------|---|---|---|
| The timings were very convenient                 | <input checked="" type="checkbox"/> 5 | 4                                     | 3 | 2 | 1 |
| The pedagogy used as very appropriate            | 5                                     | <input checked="" type="checkbox"/> 4 | 3 | 2 | 1 |
| There were sufficient breaks in between sessions | 5                                     | <input checked="" type="checkbox"/> 4 | 3 | 2 | 1 |

Assessment

|   |                                       |   |   |   |   |
|---|---------------------------------------|---|---|---|---|
| The assessment was very suitable        | <input checked="" type="checkbox"/> 5 | 4 | 3 | 2 | 1 |
| The assessment was not at all difficult | 5                                     | 4 | 3 | 2 | 1 |

This question is answered on a 10-point scale with 1 being highly unlikely to recommend and 10 being will highly recommend.

Overall Experience                      1      2      3      4      5      6      7      8      9       10

Name : S. Joseph

Signature : 

**ATTESTED**  
  
**Dr. S. RAMABALAN, M.E., Ph.D.,**  
**PRINCIPAL**  
 E.G.S. Pillay Engineering College,  
 Thethi, Nagore - 611 002.  
 Nagapattinam (Dt) Tamil Nadu.

# E.G.S. PILLAY ENGINEERING COLLEGE, NAGAPATTINAM.

## FEEDBACK FORM

Name of the Department : Civil Engineering  
Nature of the event : Training Program  
Title of the Event : Laboratory Safety Test Procedure  
Resource Person : Mr.Ramesh  
Date : 20/12/2018  
Coordinators Name : P.Malliga

### Ratings have been provided on a 5-point scale

You strongly disagree with the statement - 1 ✓  
You disagree with the statement - 2  
You neither agree nor disagree with the statement - 3  
You agree with the statement - 4  
You strongly agree with the statement - 5 ✓

### About the Content of the Program

The Program content was relevant for me 5 ✓ 4 3 2 1  
The content of the program was very comprehensive 5 4 3 2 1  
The content of the program was not repeated ✓ 5 4 3 2 1  
The overall content of the program was excellent ✓ 5 4 3 2 1

### About Resource person and Presentation

The speaker had very strong expertise in areas ✓ 5 4 3 2 1  
The speaker had excellent communication skills ✓ 5 4 3 2 1  
The speaker made the program very interesting ✓ 5 4 3 2 1  
The speaker was very well prepared for program ✓ 5 4 3 2 1

### About the Guest Lecture

The timings were very convenient ✓ 5 4 3 2 1  
The pedagogy used as very appropriate ✓ 5 4 3 2 1  
There were sufficient breaks in between sessions ✓ 5 4 3 2 1

### Assessment

The assessment was very suitable ✓ 5 4 3 2 1  
The assessment was not at all difficult ✓ 5 4 3 2 1

This question is answered on a 10-point scale with 1 being highly unlikely to recommend and 10 being will highly recommend.

Overall Experience 1 2 3 4 5 6 7 8 9 ✓ 10

Name : S. Sakthivel

Signature :  20/12/18

ATTESTED

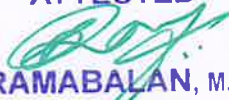
  
Dr. S. RAMABALAN, M.E., Ph.D.,  
PRINCIPAL  
E.G.S. Pillay Engineering College,  
Thethi, Nagore - 611 002.  
Nagapattinam (Dt) Tamil Nadu.

# E.G.S. PILLAY ENGINEERING COLLEGE, NAGAPATTINAM.

## FEEDBACK FORM

Name of the Department : Civil Engineering  
 Nature of the event : Training Program  
 Title of the Event : Laboratory Safety Test Procedure  
 Resource Person : Mr.Ramesh  
 Date : 20/12/2018  
 Coordinators Name : P.Malliga

Ratings have been provided on a 5-point scale

You strongly disagree with the statement - 1  
 You disagree with the statement - 2  
 You neither agree nor disagree with the statement - 3  
 You agree with the statement - 4  
 You strongly agree with the statement - 5

About the Content of the Program

|   |   |   |   |   |   |
|---|---|---|---|---|---|
| The Program content was relevant for me           | 5 | 4 | 3 | 2 | 1 |
| The content of the program was very comprehensive | 5 | 4 | 3 | 2 | 1 |
| The content of the program was not repeated       | 5 | 4 | 3 | 2 | 1 |
| The overall content of the program was excellent  | 5 | 4 | 3 | 2 | 1 |

About Resource person and Presentation

|  |   |   |   |   |   |
|--|---|---|---|---|---|
| The speaker had very strong expertise in areas | 5 | 4 | 3 | 2 | 1 |
| The speaker had excellent communication skills | 5 | 4 | 3 | 2 | 1 |
| The speaker made the program very interesting  | 5 | 4 | 3 | 2 | 1 |
| The speaker was very well prepared for program | 5 | 4 | 3 | 2 | 1 |

About the Guest Lecture

|  |   |   |   |   |   |
|--|---|---|---|---|---|
| The timings were very convenient                 | 5 | 4 | 3 | 2 | 1 |
| The pedagogy used as very appropriate            | 5 | 4 | 3 | 2 | 1 |
| There were sufficient breaks in between sessions | 5 | 4 | 3 | 2 | 1 |

Assessment

|   |   |   |   |   |   |
|---|---|---|---|---|---|
| The assessment was very suitable        | 5 | 4 | 3 | 2 | 1 |
| The assessment was not at all difficult | 5 | 4 | 3 | 2 | 1 |

This question is answered on a 10-point scale with 1 being highly unlikely to recommend and 10 being will highly commend.

Overall Experience      1      2      3      4      5      6      7      8      9      10

10

Name : G. Durga

Signature :   
20/12/18

**ATTESTED**  
  
**Dr. S. RAMABALAN, M.E., Ph.D.,**  
**PRINCIPAL**  
 E.G.S. Pillay Engineering College,  
 Thethi, Nagore - 611 002.  
 Nagapattinam (Dt) Tamil Nadu.



# E.G.S. PILLAY ENGINEERING COLLEGE, NAGAPATTINAM.

## FEEDBACK FORM

**Name of the Department** : Civil Engineering  
**Nature of the event** : Training Program  
**Title of the Event** : Laboratory Safety Test Procedure  
**Resource Person** : Mr.Ramesh  
**Date** : 20/12/2018  
**Coordinators Name** : P.Malliga

Statements have been provided on a 5-point scale

You strongly disagree with the statement - 1  
 You disagree with the statement - 2  
 You neither agree nor disagree with the statement - 3  
 You agree with the statement - 4  
 You strongly agree with the statement -  5

About the Content of the Program

|   |                                       |   |   |   |   |
|---|---------------------------------------|---|---|---|---|
| The Program content was relevant for me           | <input checked="" type="checkbox"/> 5 | 4 | 3 | 2 | 1 |
| The content of the program was very comprehensive | <input checked="" type="checkbox"/> 5 | 4 | 3 | 2 | 1 |
| The content of the program was not repeated       | <input checked="" type="checkbox"/> 5 | 4 | 3 | 2 | 1 |
| The overall content of the program was excellent  | <input checked="" type="checkbox"/> 5 | 4 | 3 | 2 | 1 |

About Resource person and Presentation

|  |                                       |              |   |   |   |
|--|---------------------------------------|--------------|---|---|---|
| The speaker had very strong expertise in areas | <input checked="" type="checkbox"/> 5 | 4            | 3 | 2 | 1 |
| The speaker had excellent communication skills | <input checked="" type="checkbox"/> 5 | 4            | 3 | 2 | 1 |
| The speaker made the program very interesting  | 5                                     | <del>4</del> | 3 | 2 | 1 |
| The speaker was very well prepared for program | 5                                     | <del>4</del> | 3 | 2 | 1 |

About the Guest Lecture

|  |                                       |                                       |   |   |   |
|--|---------------------------------------|---------------------------------------|---|---|---|
| The timings were very convenient                 | 5                                     | <input checked="" type="checkbox"/> 4 | 3 | 2 | 1 |
| The pedagogy used as very appropriate            | 5                                     | <input checked="" type="checkbox"/> 4 | 3 | 2 | 1 |
| There were sufficient breaks in between sessions | <input checked="" type="checkbox"/> 5 | 4                                     | 3 | 2 | 1 |

Assessment

|   |                                       |   |   |   |   |
|---|---------------------------------------|---|---|---|---|
| The assessment was very suitable        | <input checked="" type="checkbox"/> 5 | 4 | 3 | 2 | 1 |
| The assessment was not at all difficult | <input checked="" type="checkbox"/> 5 | 4 | 3 | 2 | 1 |

This question is answered on a 10-point scale with 1 being highly unlikely to recommend and 10 being will highly commend.

Overall Experience      1      2      3      4      5      6      7      8      9       10

Name : U. Raja Kumar

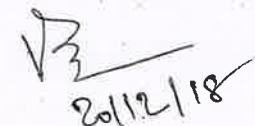
Signature :   
20/12/18

**ATTESTED**  
  
**Dr. S. RAMABALAN, M.E., Ph.D.,**  
**PRINCIPAL**  
 E.G.S. Pillay Engineering College,  
 Thethi, Nagore - 611 002.  
 Nagapattinam (Dt) Tamil Nadu.



## E.G.S.Pillay Engineering College (Autonomous)

### Certificate

This is to certify that **S. Sakthivel** from **E.G.S.Pillay Engineering College** has attended the **One Day Training Program on "Laboratory Safety Test Procedure"** organized by **Department of Civil Engineering, E.G.S.Pillay Engineering College (Autonomous), Nagapattinam on 20/12/2018..**

**Coordinator**

**HOD**

**ATTESTED**

**Dr. S. RAMABALAN, M.E., Ph.D.,  
PRINCIPAL**

**E.G.S. Pillay Engineering College,  
Thethi, Nagore - 611 002.  
Nagapattinam (Dt) Tamil Nadu.**



## **E.G.S.Pillay Engineering College (Autonomous)**

### **Certificate**

This is to certify that G.Durga from E.G.S.Pillay Engineering College has attended the One Day Training Program on “Laboratory Safety Test Procedure” organized by Department of Civil Engineering, E.G.S.Pillay Engineering College (Autonomous), Nagapattinam on 20/12/2018..

**Coordinator**

**HOD**

**ATTESTED**

**Dr. S. RAMABALAN, M.E., Ph.D.,  
PRINCIPAL**

**E.G.S. Pillay Engineering College,  
Thethi, Nagore - 611 002.  
Nagapattinam (Dt) Tamil Nadu.**



## **E.G.S.Pillay Engineering College (Autonomous)**

### **Certificate**

This is to certify that **V.Rajakumar** from **E.G.S.Pillay Engineering College** has attended the **One Day Training Program on "Laboratory Safety Test Procedure"** organized by **Department of Civil Engineering, E.G.S.Pillay Engineering College (Autonomous), Nagapattinam** on **20/12/2018..**

**Coordinator**

**HOD**

**ATTESTED**

**Dr. S. RAMABALAN, M.E., Ph.D.,  
PRINCIPAL**

**E.G.S. Pillay Engineering College,  
Thethi, Nagore - 611 002.  
Nagapattinam (Dt) Tamil Nadu.**





## E.G.S.Pillay Engineering College (Autonomous)

### Certificate

This is to certify that Ramamoorthy from E.G.S.Pillay Engineering College has attended the One Day Training Program on “Laboratory Safety Test Procedure” organized by Department of Civil Engineering, E.G.S.Pillay Engineering College (Autonomous), Nagapattinam on 20/12/2018..

**Coordinator**

**HOD**

**ATTESTED**

**Dr. S. RAMABALAN, M.E., Ph.D.,**  
**PRINCIPAL**

**E.G.S. Pillay Engineering College,**  
**Thethi, Nagore - 611 002.**  
**Nagapattinam (Dt) Tamil Nadu.**



## E.G.S.Pillay Engineering College (Autonomous)

### Certificate

This is to certify that S.Venkatesan from E.G.S.Pillay Engineering College has attended the One Day Training Program on “Laboratory Safety Test Procedure” organized by Department of Civil Engineering, E.G.S.Pillay Engineering College (Autonomous), Nagapattinam on 20/12/2018..

  
Coordinator



HOD

ATTESTED



**Dr. S. RAMABALAN, M.E., Ph.D.,**  
PRINCIPAL

E.G.S. Pillay Engineering College,  
Thethi, Nagore - 611 002.  
Nagapattinam (Dt) Tamil Nadu.

**E.G.S. PILLAY ENGINEERING COLLEGE  
(AUTONOMOUS)**

Old Nagore Road, Thethi, Nagore Village, Nagapattinam – 611002

**DEPARTMENT OF MECHANICAL ENGINEERING**



**Report**

**Two Days Training Program**

**on**

**CNC Programming**

**22.02.2019-23.02.2019**

**E.G.S. PILLAY ENGINEERING COLLEGE, Nagapattinam**

**DEPARTMENT OF MECHANICAL ENGINEERING**

**Non-Teaching Training Program**

**Title: Hands on Training on CNC Programming**

| S. No. | Content                        |
|--------|--------------------------------|
| 1.     | Report                         |
| 2.     | Approval letter from Principal |
| 3.     | Proposed Budget                |
| 4.     | Circular                       |
| 5.     | Schedule                       |
| 6.     | Attendance                     |
| 7.     | Course material                |
| 8.     | Photos                         |
| 9.     | Feedback from participants     |
| 10.    | Certificates                   |





E.G.S. PILLAY ENGINEERING COLLEGE, NAGAPATTINAM  
(Autonomous)  
Accredited by NAAC with 'A' Grade  
Department of Mechanical Engineering  
(Accredited by NBA)

A REPORT ON TWO DAY TRAINING PROGRAM  
ON  
CNC PROGRAMMING

The department of Mechanical Engineering, E.G.S. Pillay Engineering College, Nagapattinam organized a training program for non-teaching faculty members of E.G.S. Pillay group of institutions on 22.02.2019 and 23.02.2019. The program was entitled as "Hands on Training on CNC Programming". The coordinator for this program was Dr. V. Sivaramakrishnan, Professor, Department of Mechanical Engineering.

The session was inaugurated by the Hon'ble secretary of the Institution Shri.S.Pamesvaran, and the E. G. S. Pillay trust member Mr. S. Sankarganesh, Principal Dr. S. Ramabalan and Controller of Examination Dr. M. Chinnadurai. The Prof.G. Sundaravadivel welcomed the gathering and followed by inaugural speech by Dr. G. Gurumoorthi, HOD/MECH.

The training session was handled by the internal expert member Dr. J. Jeevamalar, Professor/MECH. Initially, a lecture session was given on the operation of CNC machines, G- and M-codes used in the coding of CNC program. The lecture helped the participants to understand about the G and M programming codes and enabled them to write simple CNC program codes. Then, a hands-on training session was given to the participants on the handling of CNC machine by implementing basic programming codes.

Finally, certificates were distributed to all the participants and vote of thanks was given by Mr. B. Harish Keerthi, assistant professor, department of mechanical.

*V. Sivaramakrishnan*  
PROGRAM COORDINATOR

**ATTESTED**  
*[Signature]*  
**Dr. S. RAMABALAN, M.E., Ph.D.,**  
PRINCIPAL

E.G.S. Pillay Engineering College,  
Thethi, Nagore - 611 002.  
Nagapattinam (Dt) Tamil Nadu.

*[Signature]*  
HOD/MECH

From

Dr.G.Gurumoorthi  
Head of the department  
Department of Mechanical Engineering  
E.G.S.Pillay Engineering College  
Nagapattinam

To

The principal  
E.G.S.Pillay Engineering College  
Nagapattinam.

13/2/19

Sub: Request for permission to conduct training program for non-teaching staff-reg

Respected Sir,

As per the instruction from management, the department of Mechanical Engineering has planned to conduct a training program on hands on training on CNC programing for the non-teaching staff of civil, electrical and electronics and Mechanical Engineering. So, in this context I kindly request to avail permission to pursue the program in the month of February 2019.

Thanking you

Date: 13.02.2019

Place: Nagapattinam.

**ATTESTED**  
  
**Dr. S. RAMABALAN, M.E., Ph.D.,**  
**PRINCIPAL**  
E.G.S. Pillay Engineering College,  
Thethi. Nagore - 611 002.  
Nagapattinam (Dt) Tamil Nadu.

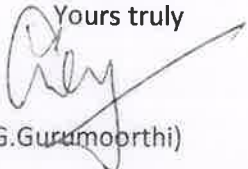
Yours truly  
  
(Dr.G.Gurumoorthi)

**E.G.S. PILLAY ENGINEERING COLLEGE, Nagapattinam**

**DEPARTMENT OF MECHANICAL ENGINEERING**

Title: Hands on Training on CNC Programming

Date: 22.02.2019&23.02.2019

**PROPOSED BUDGET**

| S. No.              | ITEMS DESCRIPTION                  | QUANTITY REQUIRED | AMOUNT / QUANTITY (Rs.) | ESTIMATED AMOUNT (Rs.) |
|---------------------|------------------------------------|-------------------|-------------------------|------------------------|
| 1.                  | Tea & Snacks                       | 15*(4 sessions)   | 15                      | 900                    |
| 2.                  | Flex                               | 1                 | 300                     | 300                    |
| 3.                  | Report preparation                 | 1                 | 200                     | 200                    |
| 4.                  | Certificate                        | 9                 | 30                      | 350                    |
| 5.                  | Food for Participants & Organizers | 15*(2 sessions)   | 80                      | 2400                   |
| <b>Total Amount</b> |                                    |                   |                         | <b>4150</b>            |

**ATTESTED**

**Dr. S. RAMABALAN, M.E., Ph.D.,  
PRINCIPAL**

**E.G.S. Pillay Engineering College,  
Thethi, Nagore - 611 002.  
Nagapattinam (Dt) Tamil Nadu.**

*V. Sivanahidhan*  
Program Coordinator

*[Signature]*  
HoD/Mech

**E.G.S.Pillay Engineering College,  
Nagapattinam.  
Department of Mechanical Engineering**

**Circular**

Date: 15.02.2019

It is hereby informed to the non-teaching staffs of the department of Mechanical, Civil and Electrical and electronics engineering, the department of Mechanical Engineering is hereby planned to conduct a hands on training on CNC programming for two days from 22.02.2019– 23.02.2019. All the non-teaching staffs of the above said department are instructed to attend the program without fail.

**ATTESTED**  
  
**Dr. S. RAMABALAN, M.E., Ph.D.,  
PRINCIPAL**  
E.G.S. Pillay Engineering College,  
Thethi, Nagore - 611 002.  
Nagapattinam (Dt) Tamil Nadu.

  
HOD/Mech

Copy to:

The Secretary, The Joint Secretary The Principal, All HODs, Office file, Department file



E.G.S. PILLAY ENGINEERING COLLEGE, NAGAPATTINAM

DEPARTMENT OF MECHANICAL ENGINEERING

Non-Teaching Training Program

Title: Hands on Training on CNC Programming

Date: 22/02/2019 TO 23/02/2019

1. PROGRAM SCHEDULE:

| S.NO | DATE       | SESSION | COURSE DESCRIPTION                                   | BENEFICIARIES  |
|------|------------|---------|--|--|
| 1    | 22.02.2019 | FN      | Introduction on CNC programming and part programming | Non-teaching staffs of department of Mechanical, Civil and EEE |
|      |            | AN      | Program writing for different operation              |  |
| 2    | 23.02.2019 | FN      | Hands on session on CNC programming                  |  |
|      |            | AN      | Hands on session on CNC programming                  |  |

2. PARTICIPANTS DETAILS:

| PARTICIPANTS DETAILS                     | MAXIMUM NUMBER OF PARTICIPANTS |
|--|--------------------------------|
| All Technical Assistant/Supporting staff | 20                             |

3. RESOURCE PERSONS:

| RESOURCE PERSON                                | CONVENER                                      | PROGRAM COORDINATOR                       |
|--|---|---|
| Dr. J. Jeevamalar,<br>Associate Professor/MECH | Dr. G. Gurumoorthi,<br>Professor and HOD/MECH | Dr. V. Sivaramakrishnan<br>Professor/MECH |

*V. Sivaram Krishnan*  
Program coordinator

ATTESTED  
*Prof.*  
Dr. S. RAMABALAN, M.E., Ph.D.,  
PRINCIPAL  
E.G.S. Pillay Engineering College,  
Thethi, Nagore - 611 002.  
Nagapattinam (Dt) Tamil Nadu.

*HOD*

**E.G.S.PILLAY ENGINEERING COLLEGE, NAGAPATTINAM**  
**DEPARTMENT OF MECHANICAL ENGINEERING**  
**TRAINING PROGRAM FOR NON-TEACHING STAFF**  
**ATTENDANCE**

| S.NO | STAFF NAME       | DEPARTMENT | 22.02.2019 |    | 23.02.2019 |    |
|------|------------------|------------|------------|----|------------|----|
|      |                  |            | FN         | AN | FN         | AN |
| 1    | Mr.S.Sakthivel   | MECHANICAL | JS         | JS | JS         | JS |
| 2    | Mr.S.Venkatesan  | MECHANICAL | SV         | SV | SV         | a  |
| 3    | Mr.K.Rajasekaran | MECHANICAL | KR         | KA | KR         | KR |
| 4    | Mr.S.Ramamoorthy | CIVIL      | he         | hm | he         | hr |
| 5    | Mr.G.Chellappa   | MECHANICAL | de         | de | a          | de |
| 6    | Mr.V.Ramu        | MECHANICAL | VR         | VR | VR         | a  |
| 7    | Mr.K.Balamurugan | MECHANICAL | BM         | Bm | Bm         | Bm |
| 8    | Mr.R.Vignesh     | EEE        | VJ         | VJ | VJ         | VJ |
| 9    | Mr.M.Nagarajan   | EEE        | MM         | MM | MM         | MM |

V. Swaminathan.

**ATTESTED**

**Dr. S. RAMABALAN, M.E., Ph.D.,**  
**PRINCIPAL**

**E.G.S. Pillay Engineering College,**  
**Thethi, Nagore - 611 002.**  
**Nagapattinam (Dt) Tamil Nadu.**



# Computer Aided Manufacturing

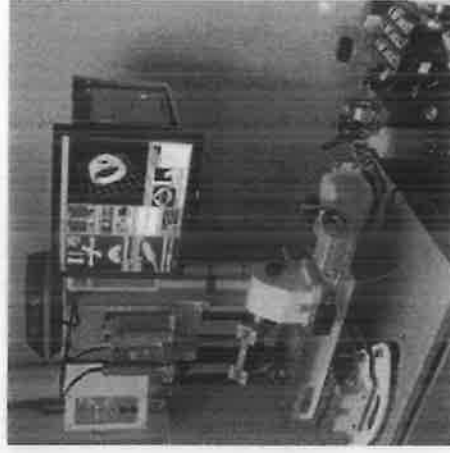

**A.ARUNKUMAR,  
ASSISTANT PROFESSOR,  
DEPARTMENT OF MECHANICAL ENGINEERING,  
E.G.S. PILLAY ENGINEERING COLLEGE,  
NAGAPATTINAM.**

## Unit III

# PROGRAMMING OF CNC LATHE

Coordinate system - structure of a part program -G & M Codes - Programming for FANUC and SIEMENS controller -Single pass and canned cycle -Turning, facing and threading -**Multi-pass canned cycle -Rough and Finish turning, facing, pattern repeating, grooving, threading, drilling, boring, peck drilling, high speed drilling cycle** -Subprogram and Macro programming -Tool length and nose radius compensation - offset -Tool, work and coordinate -Insert -Materials, Classification, Nomenclature and Selection -Tool and Work holding devices -Automatic tool changer -Turret and drum type -Tool holder nomenclature and selection -CNC part programming using CAD/CAM software and interfacing with CNC machines



# Prerequisite Knowledge

- Metal cutting processes

# 3. EVOCATION

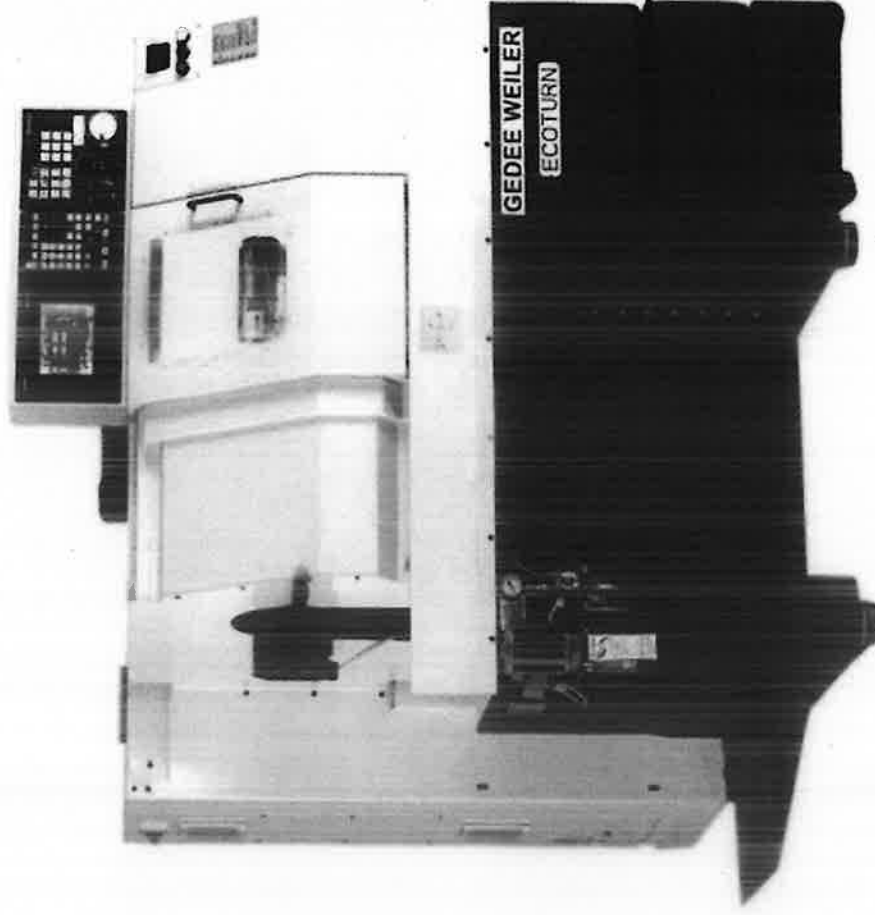
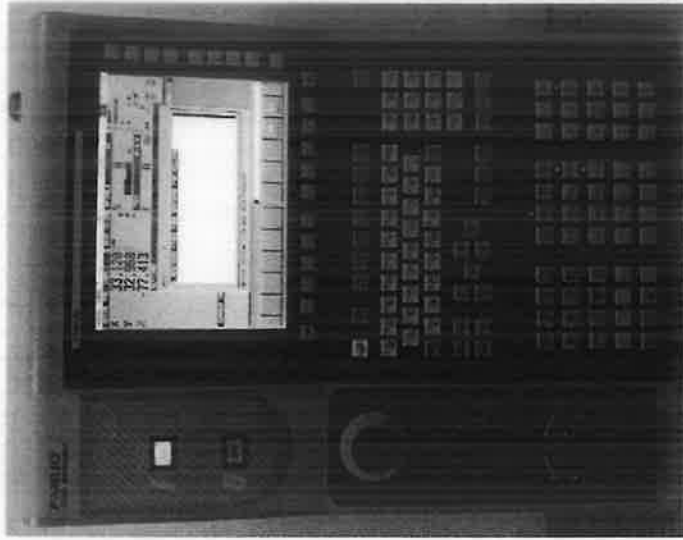

## **4. GENERAL OBJECTIVE (GO)**

- Students will be able to apply the knowledge to create CNC part program for circular components with canned cycles.

## **5. SPECIFIC OBJECTIVE (SO) MAPPED WITH STEM**

The students will be able to

1. Label the canned cycles used in CNC lathe programming with their syntax. (R-F) (E)
2. Explain the function and application areas of canned cycles (G70-G76). (U-C) (E)
3. Select the suitable canned cycles for CNC part programming of given component and construct part program for same component. (Ap-C) (E)



## **MULTIPLE REPETITIVE CANNED CYCLE (G70-G76)**

1. Roughing cycle (G71)
2. Facing cycle (G72)
3. Pattern repeating cycle (G73)
4. Finishing cycle (G70)
5. Peck drilling cycle (G74)
6. Grooving cycle (G75)
7. Threading cycle (G76)

## STOCK REMOVAL CYCLE (G71)

- Also called as roughing cycle
- The material will be removed when the tool moves parallel to the spindle axis
- Since it is a roughing cycle, the material removal rate will be more
- In this cycle, small amount of material is retained on the work piece which will be removed later by finishing cycle

## FINISHING CYCLE (G70)

- In this cycle, the excess material is removed which was retained during previous operations
- This cycle will be used at the end of roughing, facing and pattern repeating cycles
- since it is a finishing operation, the material removal rate will be less

# Discussion

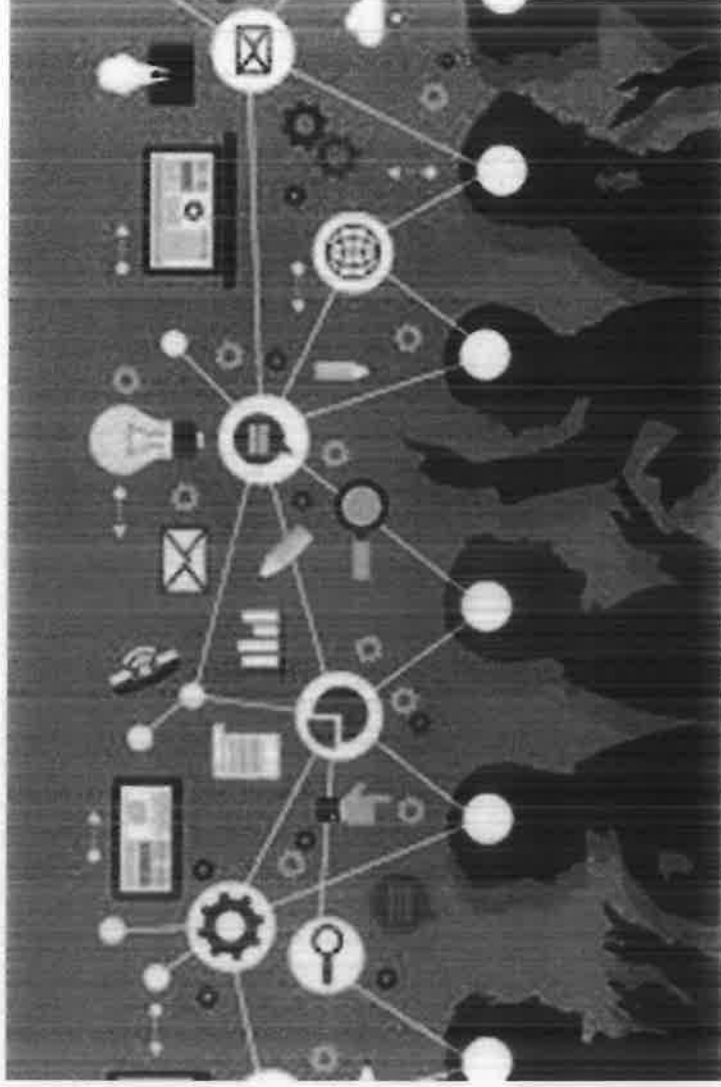

10 mins

## Calling a Subroutine

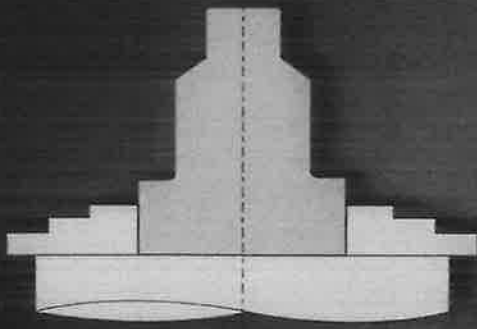

# G70 P Q

LATHE EXAMPLE

G70 - FINISH TURN CYCLE

P - LINE NUMBER AT START OF SUBROUTINE

Q - LINE NUMBER AT END OF SUBROUTINE

## G71 Roughing Cycle

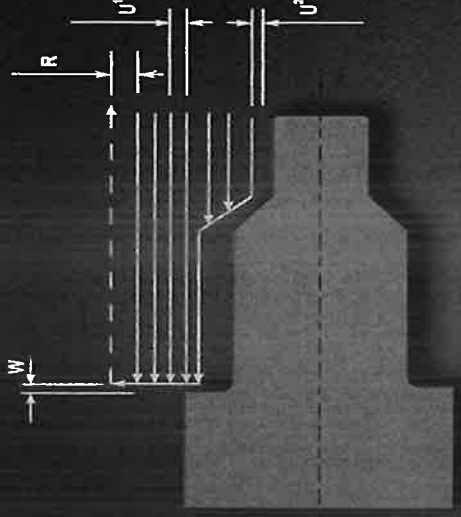

# G71 U1.0 R1.0;

# G71 P100 Q200 U0.2 W.05 F0.2

G71 - ROUGHING CYCLE

U1.0 (U ) - DEPTH OF CUT

R1.0 - RETRACT VALUE

P100 - FIRST LINE OF SUBROUTINE

Q200 - LAST LINE OF SUBROUTINE

U0.2 (U ) - AMOUNT LEFT ON FOR FINISHING IN X

W0.05 - AMOUNT LEFT ON FOR FINISHING IN Z

F0.2 - FEED RATE



# Roughing Cycle G71 & Finishing Cycle G70

Stock Removal (Roughing Cycle)

**G71 U\_\_ R\_\_**

U= DEPTH OF CUT PER PASS IN X AXIS

R= RELIEF AMOUNT AFTER EACH PASS

**G71 P\_\_ Q\_\_ U\_\_ W\_\_ F\_\_**

P= PROFILE STARTING BLOCK NUMBER

Q= PROFILE END BLOCK NUMBER

U= FINISHING ALLOWANCE IN X AXIS

W= FINISHING ALLOWANCE IN Z AXIS

F= FEED RATE

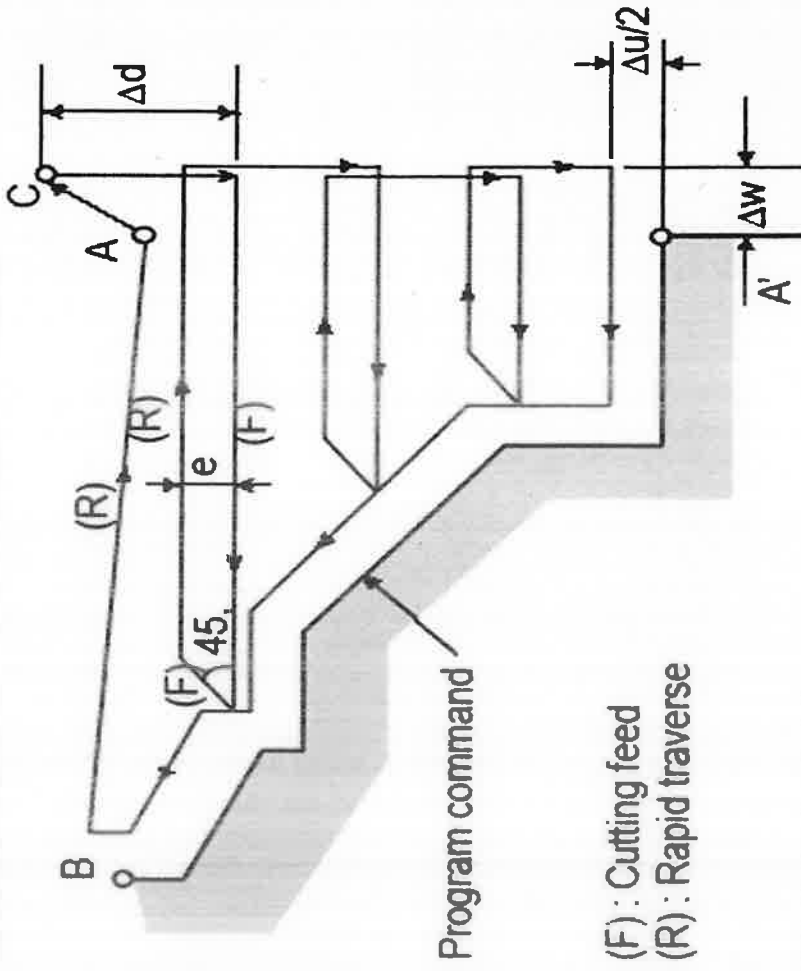

(F) : Cutting feed

(R) : Rapid traverse

Finishing cycle **G70 P\_\_ Q\_\_**

P= PROFILE STARTING BLOCK NUMBER

Q= PROFILE END BLOCK NUMBER

# Example

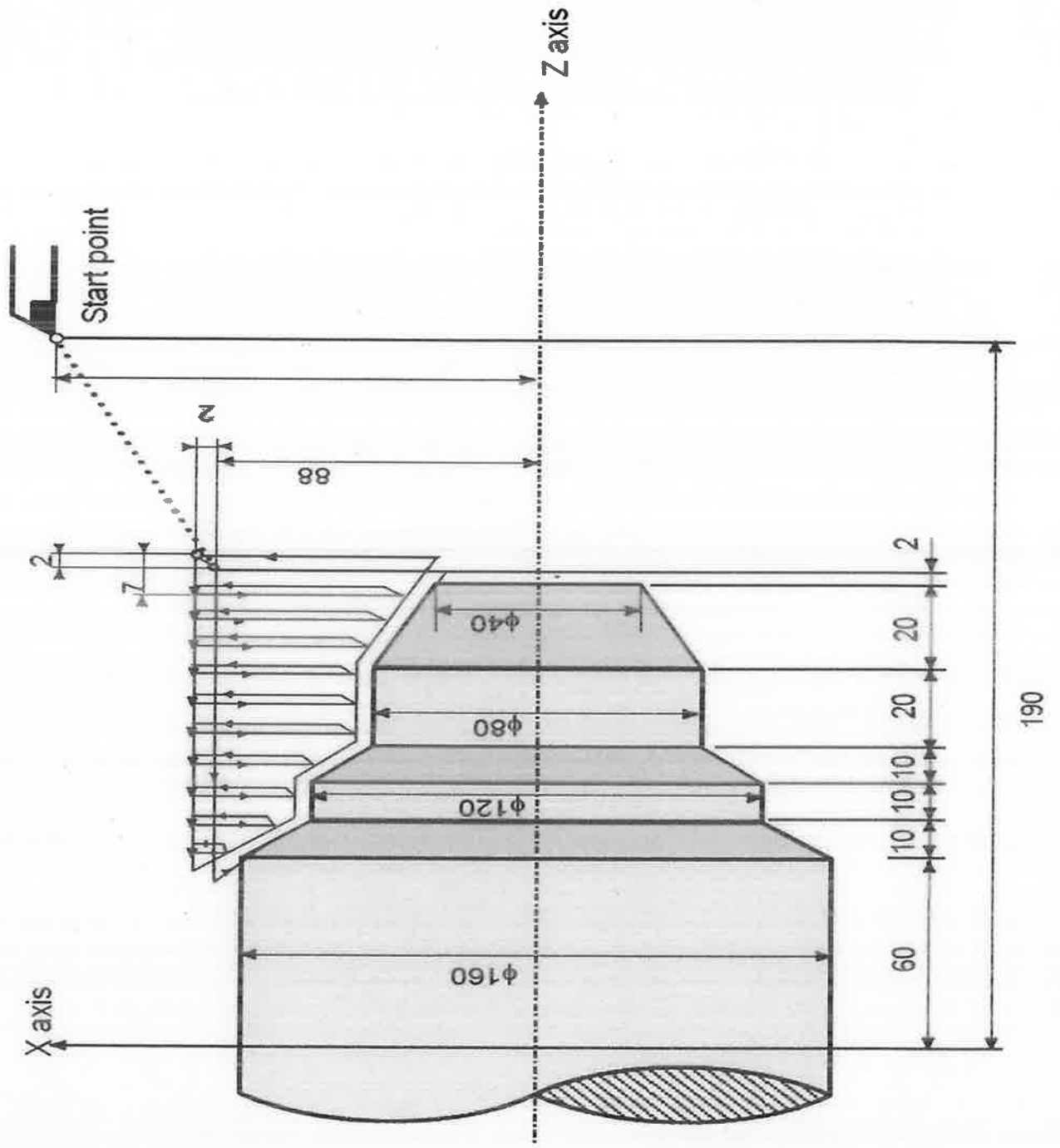

- O0006;
- N10 G21 G99;
- N20 G28 U0 W0;
- N30 T0101;
- N40 S1250 M03;
- N50 G00 X161.0;
- N60 G00 Z0.0;
- N70 G01 X-1.0F0.3;
- N80 G00 Z2.0;
- N90 G00 X161.0;
- N100 G00 Z0.0;
- **N110 G71 U2.0 R1.0;**
- **N120 G71 P130 Q180 U0.25 W0.2 F0.3;**
- N130 G01 X40 F0.3;
- N140 G01 X80 Z-20 F0.5;
- N150 Z-40;
- N160 X120 Z-50;
- N170 Z-60;
- N180 X160 Z-70;
- **N190 G70 P130 Q180;**
- N200 G28 U0 W0 ;
- N210 M05;
- N220 M30;

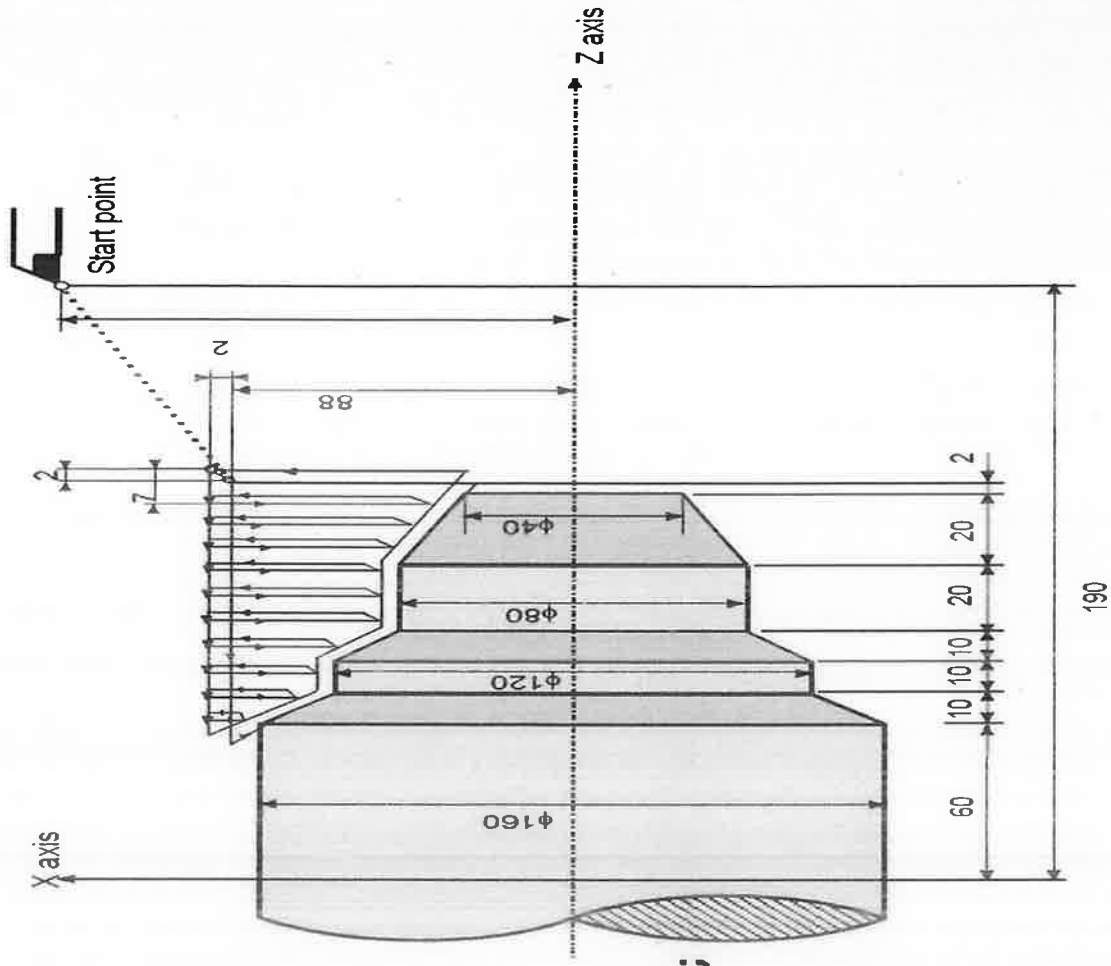

## G72 Facing Cycle

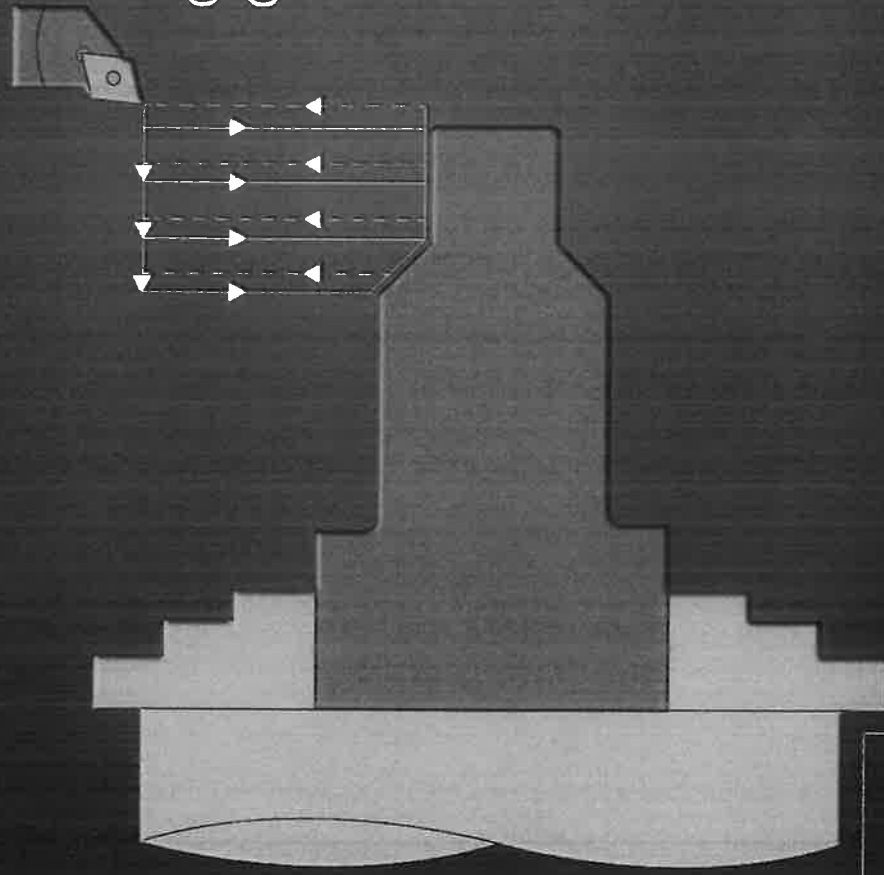

```
G72 W0.8 R2.0;  
G72 P200 Q300 U1.0 W0.5 F0.2;
```

G72 - Facing cycle  
W0.8 - Depth of cut  
R2.0 - Retract value  
P200 - Start of subroutine  
Q300 - End of subroutine  
U1.0 - Finish allowance in X  
W0.5 - Finish allowance in Z  
F0.2 - Feedrate





# Canned Cycle – G72 & G70 (Facing)

- O0003;
- N010 G21 G40 G99;
- N020 G28 U0 W0;
- N030 T0101;
- N040 M03 S1200;
- N050 G00 X31 Z5;
- N060 G01 Z0;
- N070 G72 U0.5 R1 ; **//\*** Multiple facing
- \*\*//**
- N080 G72 P90 Q180 U0.2 W0.2 F30;
- N090 G01 Z-22.5 F40;
- N100 X30;
- N110 X26;
- N120 Z-17.5;
- N130 X20 Z-15;
- N140 Z-10;
- N150 G02 X10 Z-5 R5 F40;
- N160 G01 Z-2.5 F50;
- N170 X5 Z0;
- N180 X0;
- N190 G70 P90 Q180; **//\*** Finishing cycle **\*\*//**
- N200 G28 U0 W0;
- N210 M05;
- N220 M30;

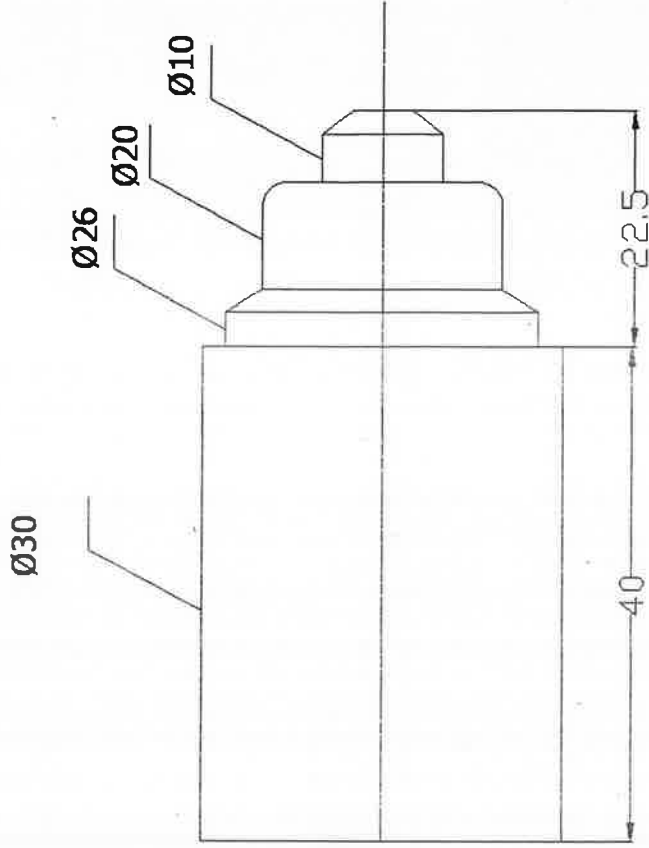

## PATTERN REPEATING CYCLE (G73)

- In this cycle, the tool traces the pattern repeatedly and removes a part of material during each repeat
- The number of traces (repeats) are programmed in the cycle.
- Small amount of material is retained in the work piece which will be removed later during finishing cycle

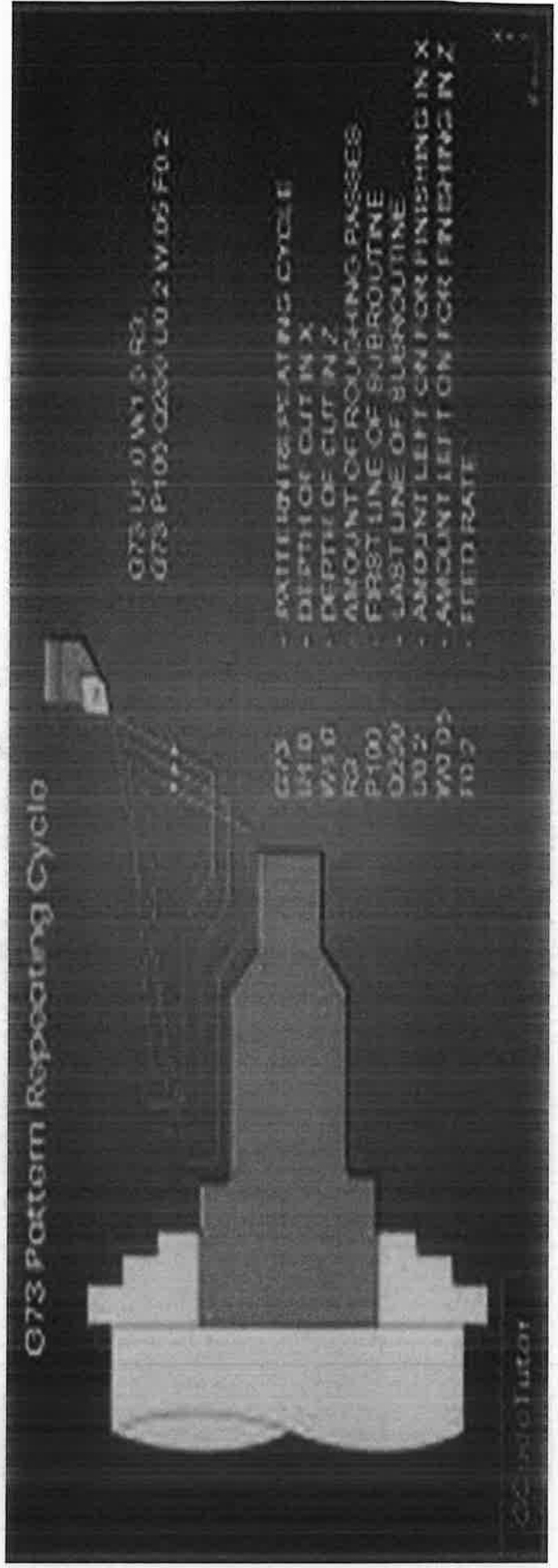

# Format of Pattern Repeating Cycle - G73

G73 U\_\_W\_\_R\_\_  
G73 P\_\_Q\_\_U\_\_W\_\_F\_\_

U = Distance and Direction of Relief in X Direction

W = Distance and Direction of Relief in Z Direction

R = The Number of Division (Number Of Passes)

P = Profile Starting Block Number

Q = Profile Ending Block Number

U = Finishing Allowance in X Axis

W = Finishing Allowance in Z Axis

F = Feed Rate

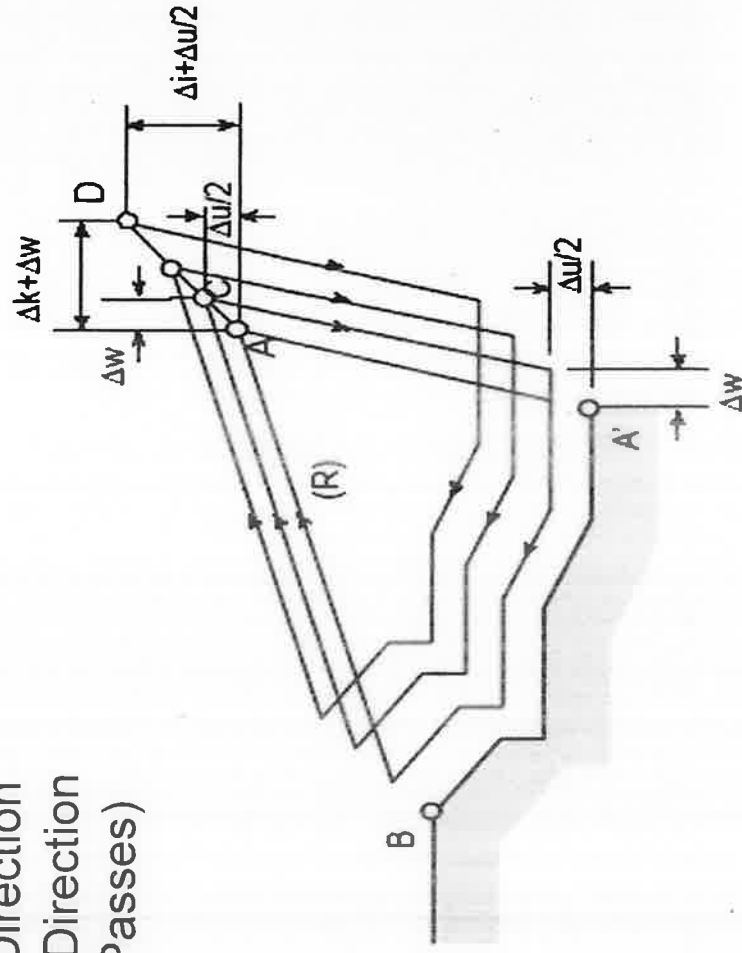



# Example

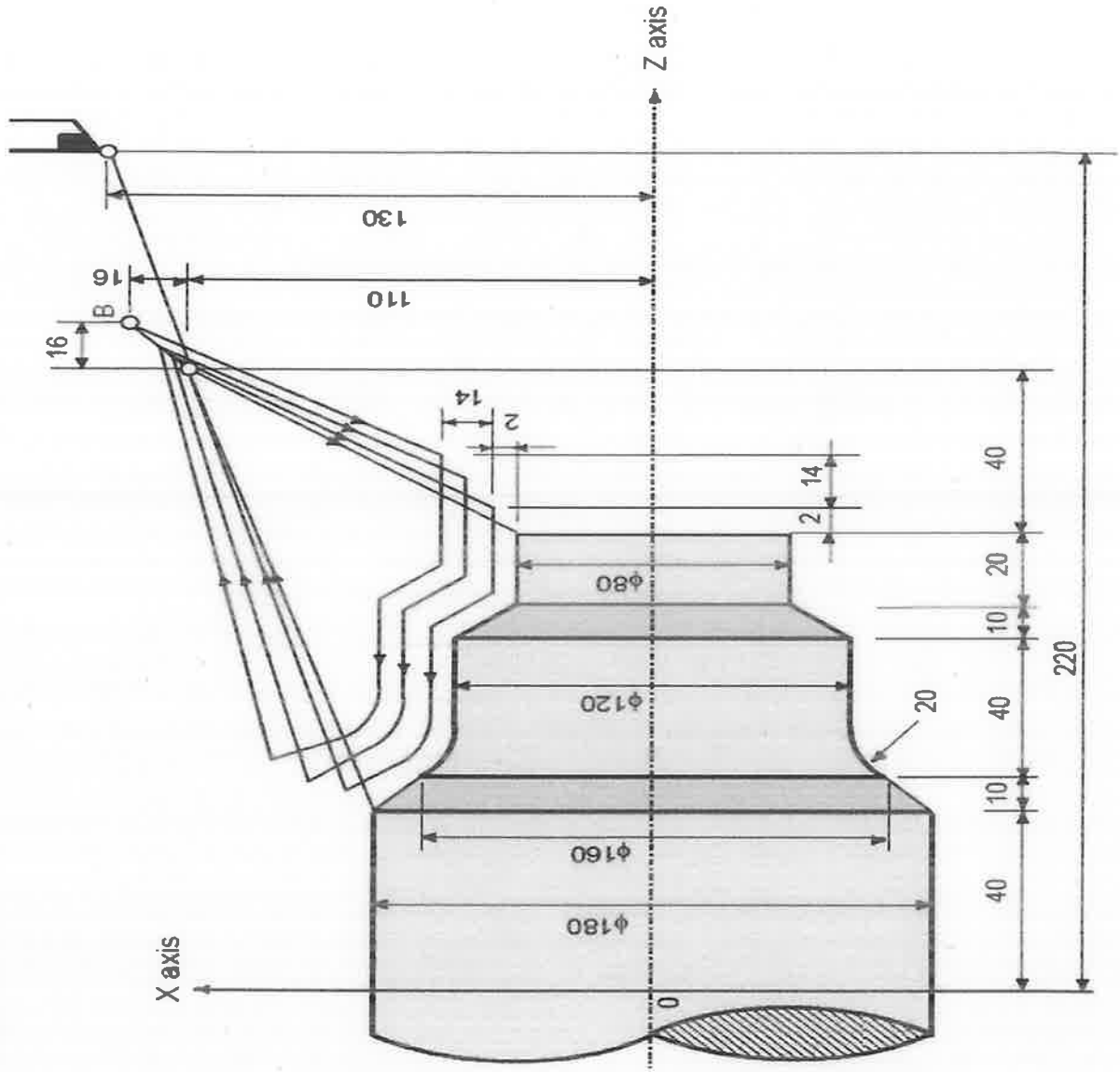

(Diameter designation, metric input)

## PECK DRILLING CYCLE (G74)

### FORMAT OF PECK DRILLING CYCLE

G74 R\_\_;

G74 Z\_\_ Q\_\_ F\_\_;

R = RELIEF AMOUNT AFTER EACH PASS

Z = FINAL DRILLING DEPTH

Q = DEPTH OF CUT PER EACH PASS IN MICRON

F = FEED RATE

In this cycle, the drilling of total depth will be done by repeated steps. During each step, a part of the total depth (Q) will be drilled

# EXAMPLE FOR DRILLING CYCLE

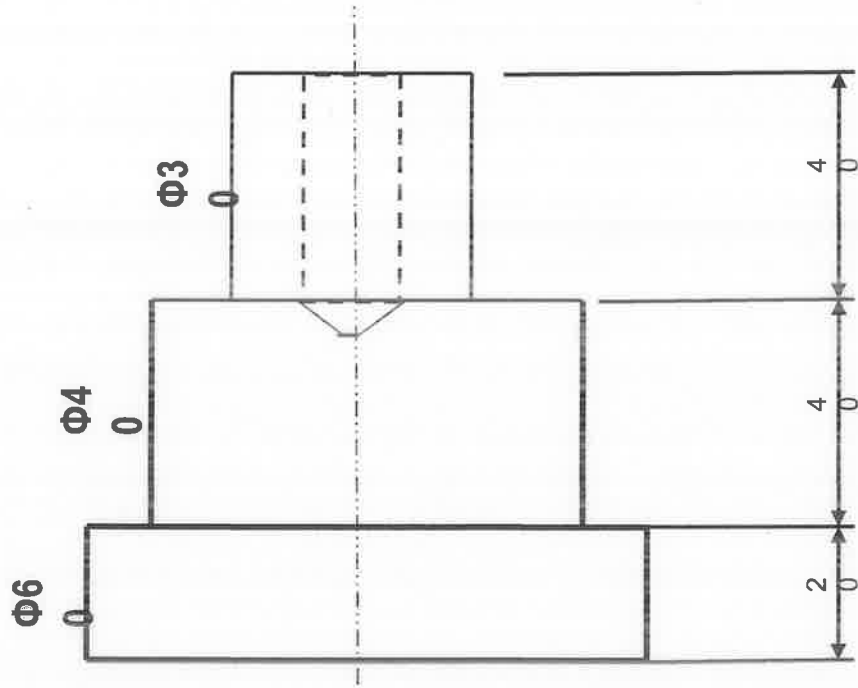

Drill  
dia. 15mm,  
deep 40mm

# Canned Cycle – G74 (Peck Drilling)

- O0010:
- N10 G21 G99;
- N20 G28 U0 W0;
- N30 T0303; (15mm  $\emptyset$ drill)
- N40 S1250 M03;
- N50 G00 X0.0;
- N60 Z2.0;
- N70 G74 R2.0;
- N80 G74 Z-40.0 Q8000 F0.3;
- N90 G28 U0 W0;
- N100 M05;
- N110 M30;

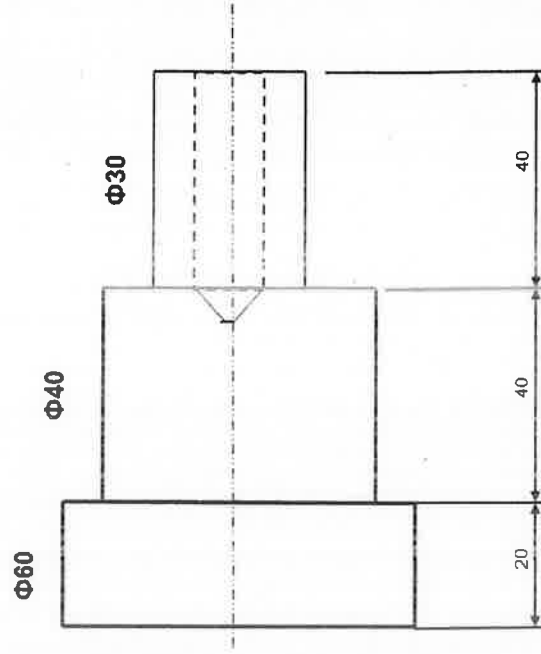



# GROOVING CYCLE (G75)

## FORMAT OF GROOVING CYCLE

G75 R\_\_\_;  
G75 X\_\_\_ Z\_\_\_ P\_\_\_ Q\_\_\_ F\_\_\_;

R = RELIEF AMOUNT  
X = FINAL VALUE OF X AT THE END OF GROOVING  
Z = FINAL VALUE OF Z AT THE END OF GROOVING  
P = DEPTH OF CUT PER EACH PASS (MICRON)  
Q = SHIFTING DISTANCE IN Z AXIS (MICRON)  
F = FEED RATE

In this cycle,

1. The material of total depth will be removed by repeated steps in X axis.
2. Then the tool is shifted in Z axis for a specified distance

The steps 1 and 2 will be repeated until the groove completion

# GROOVING CYCLE (G75)

- N10 G21 G99;
- N20 G28 U0 W0;
- N30 T0404; (Grooving Tool )
- N40 S1250 M03;
- N50 G00 X41.0;
- N60 Z-40.0;
- N70 G75 R1.0;
- N80 G75 X30.0 Z-70.0 P1000 Q5000 F0.3;
- N90 G28 U0 W0;
- N100 M05;
- N110 M30;

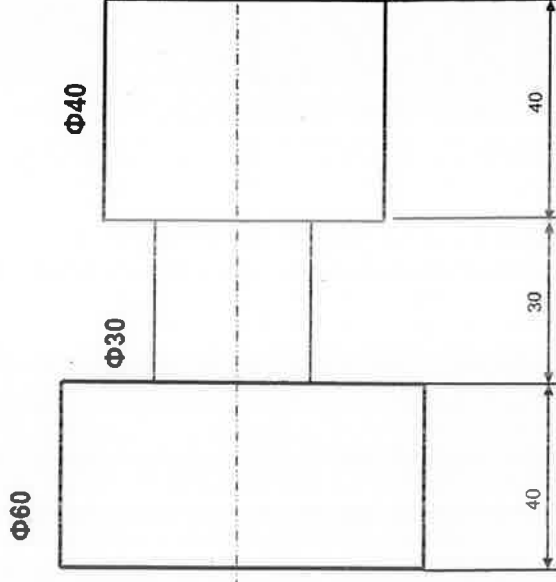

## Format of Threading Canned Cycle - G76

G76 P\_\_ Q\_\_ R\_\_

G76 X\_\_ Z\_\_ P\_\_ Q\_\_ F\_\_

P\_\_ = Number of finishing passes  
\_\_ = Chamfer distance multiplication factor  
\_\_ = Included angle  
Q = Minimum depth of cut (Micron)  
R = Finishing allowance

X = Minor diameter of the thread  
Z = The value of Z at the end of the thread  
P = Height of thread (Micron)  
Q = First depth of cut (Micron)  
F = Pitch

# Example

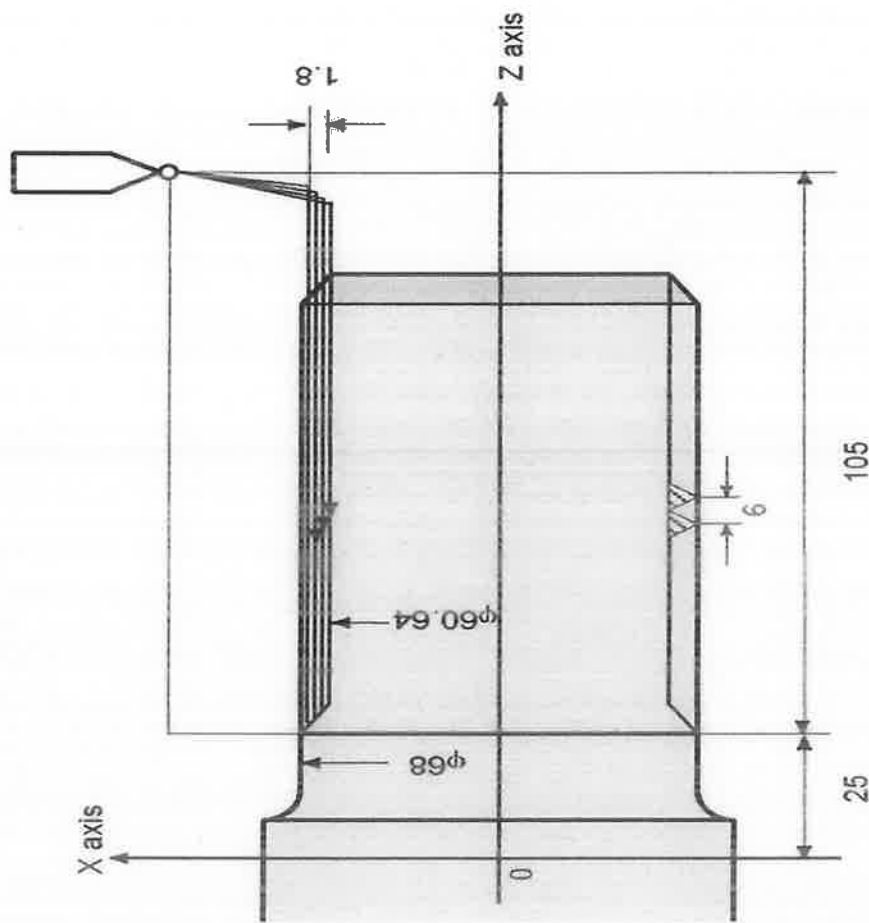
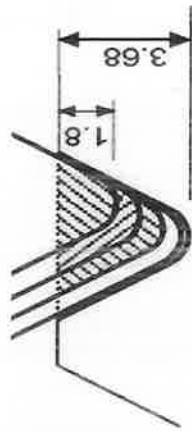

G80 X80.0 Z130.0;  
G76 P011060 Q100 R200 ;  
G76 X60.64 Z25.0 P3680 Q1800 F6.0 ;



# THREADING CYCLE (G76)

Thread specification :

M40x2P

→ Major Dia = 40 mm  
→ Pitch = 2 mm

→ Minor Dia = Major Dia – 2 x depth of thread  
→ Dept of thread = 0.6315 x pitch = 1.2630mm

Hence Minor Dia = 37.474  
( Included angle for metric thread is 60 Deg )

- O0014
- N10 G21 G99;
- N20 G28 U0 W0;
- N30 T0101;(Turning Tool )
- N40 S1500 M0;
- N50 G00 X81.0; (Facing)
- N60 Z0.0;
- N70 G01 X-1.0 F0.5;
- N80 Z2.0;
- N90 G00 X80;
- N100 Z0.0;
- N110 G71 U2.0 R1.0; ( Rough turning Cycle)
- N120 P130 Q170 U0.3 W0.2 F0.3;
- N130 G01 X40.0 F0.3;
- N140 Z-70.0;
- N150 X60.0;
- N160 Z-110.0;
- N170 X80.0;
- N180 G70 P130 Q170; (Finishing Cycle)
- N190 G28 U0W0;
- N200 M05;

- N210 T0202 ;(Grooving Tool)
- N220 S1500 M03;
- N230 G00 X41.0;
- N240 Z-40.0;
- N250 G75 R1.0;
- N260 G75 X30.0 Z-70.0 P1000 Q1000 F0.3;
- N270 G28 U0 W0 ;
- N280 M05;
- N290 T0303; (Drilling Cycle)
- N300 S1500 M03;
- N310 G00 X0.0;
- N320 Z2-0;
- N330 G74 R2.0;
- N340 G74 Z-50.0 Q8000 F0.3;
- N350 G28 U0 W0;
- N360 M05;
- N370 T0303;(Threading Cycle)
- N380 S1200 M03;
- N390 G00 X41.0;
- N400 Z-40.0;
- N410 G01 X40.0 F0.3;
- N420 G76 P020860 Q100 R0.01;
- N430 G76 X37.474 Z0.0 P1263 Q200 F2.0;
- N440 G00 X42.0;
- N450 Z2.0;
- ~~N460 G28 U0 W0;~~
- N470 M05;
- N480 M30;

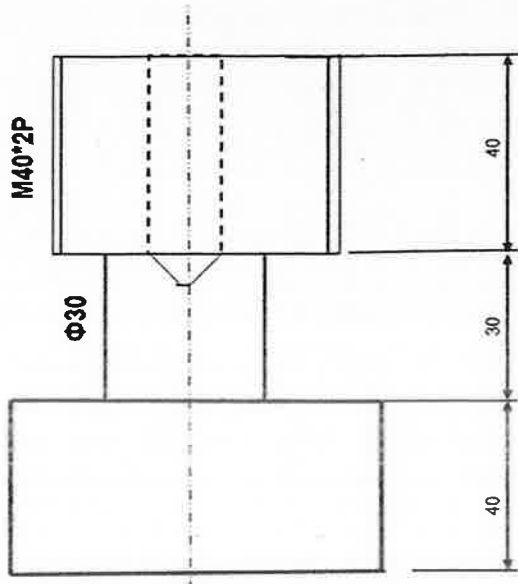

CNCEZ TURNING - IV

# CNCEZ THREAD CUTTING SPECIMEN DRAWING

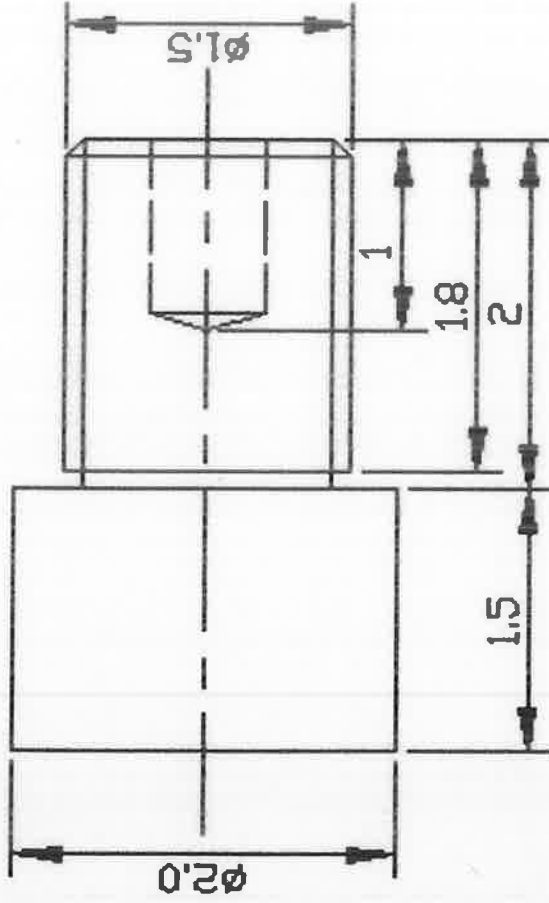

ALL DIMENSIONS ARE  
IN Inches

## Program:

:%  
: 1004  
N05 G90 G20  
N10 M03 S1500  
N15 M06 T01  
N20 G00 X0 Z0  
N25 G01 X1.5 Z0 F10  
N30 G01 X1.5 Z-2  
N35 G01 X2.0 Z-2  
N40 G00 X1.5 Z2  
N45 M06 T03  
N50 G00 X1.5 Z0  
N55 G76 X1.5 Z-1.8 D625 K.125 A45 F0.1  
N60 G00 X2 Z2  
N65 M06 T12  
N70 G00 X0 Z0  
N75 G74 X0 Z-1 F1 D0 I0.25 K.125  
N80 G00 Z1  
N85 M05  
N90 M30

## Common G-Code for Lathe

**G77 X\_\_ Z\_\_ Q\_\_ R\_\_ F\_\_ ;**

**Canned cycles (side turning), (X,Z) – end point coordinate, Q – depth of each cut, R – depth of taper, F – feedrate**

**straight side turning: X, Z, F**

**roughing cuts: X, Z, Q, F**

**making tapers: X, Z, Q, R, F**

**G80 ;**

**Cancel a canned cycle, and resume normal operation (G00 or G01 can also cancel canned cycles)**



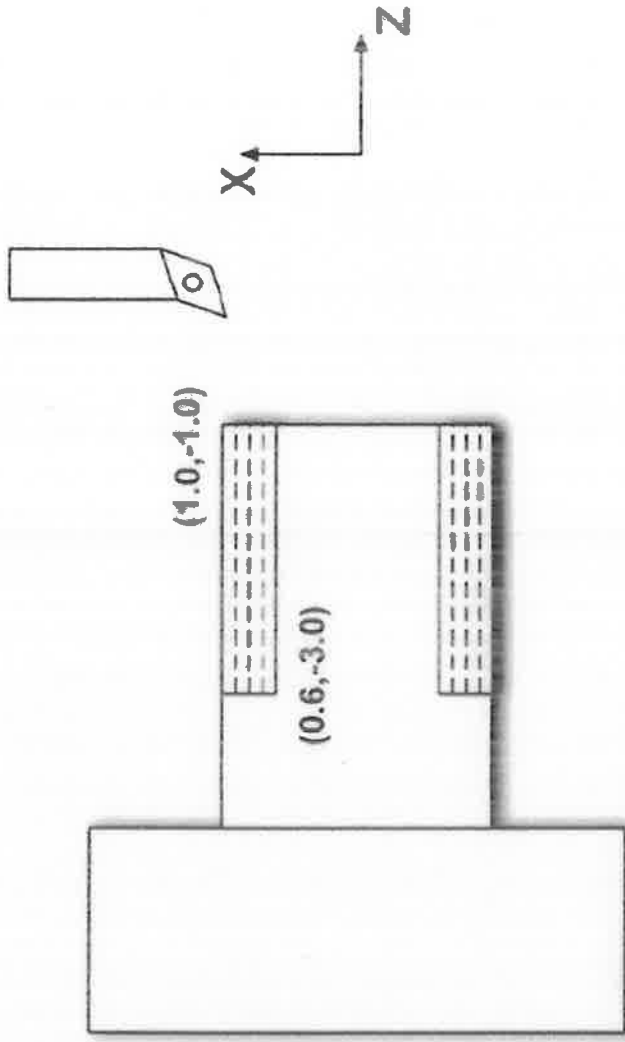

Canned cycle side turning:

N001 G01 X1.0 Z-1.0 F10

N002 G77 X0.6 Z-3.0 Q0.1 F10

N003 G80

X,Z are end point coordinates, Q is depth of each cut

# Canned Full Positive Taper

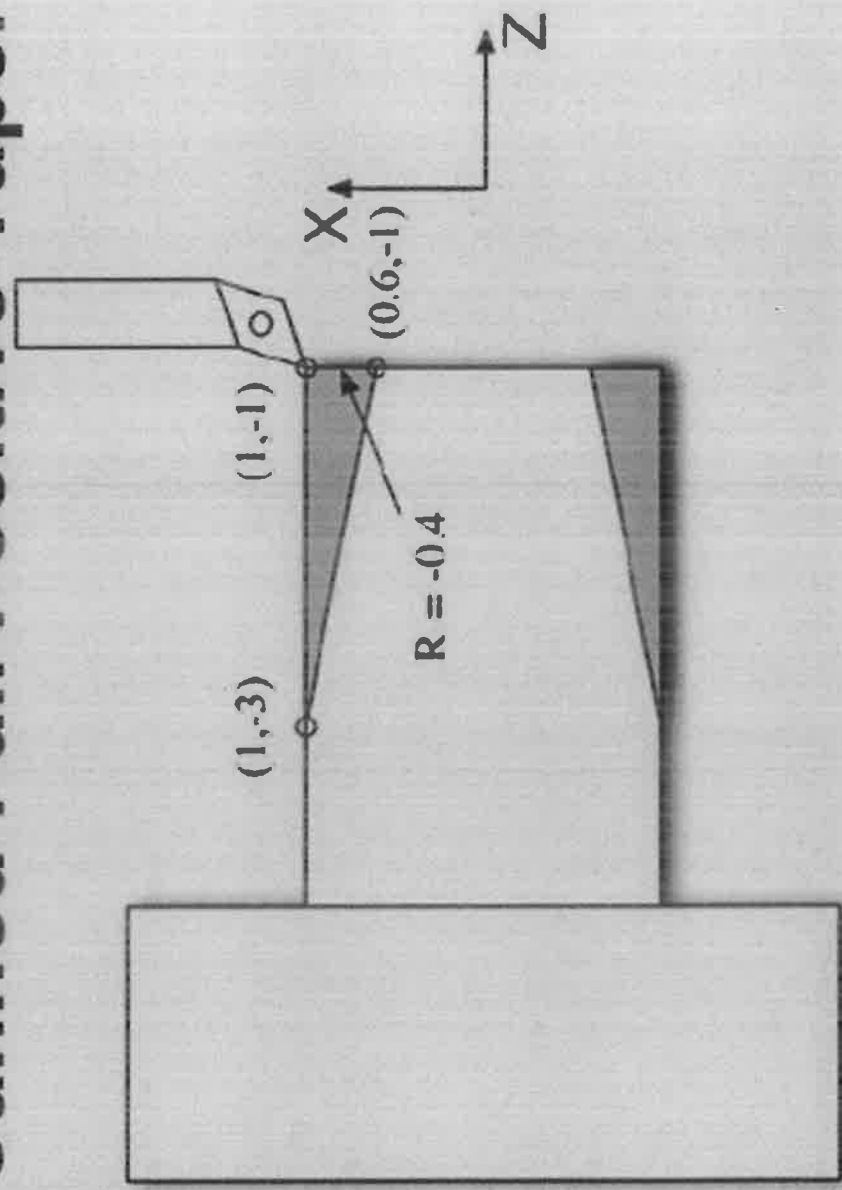

Canned cycle side turning with taper:

N011 G01 X1.0 Z-1.0 F10; Taper start point

N012 G77 X1.0 Z-3.0 Q0.1 R-0.4 F10; Taper end point

N013 G80

;R is depth of taper, negative values for positive taper

# Canned Full Negative Taper

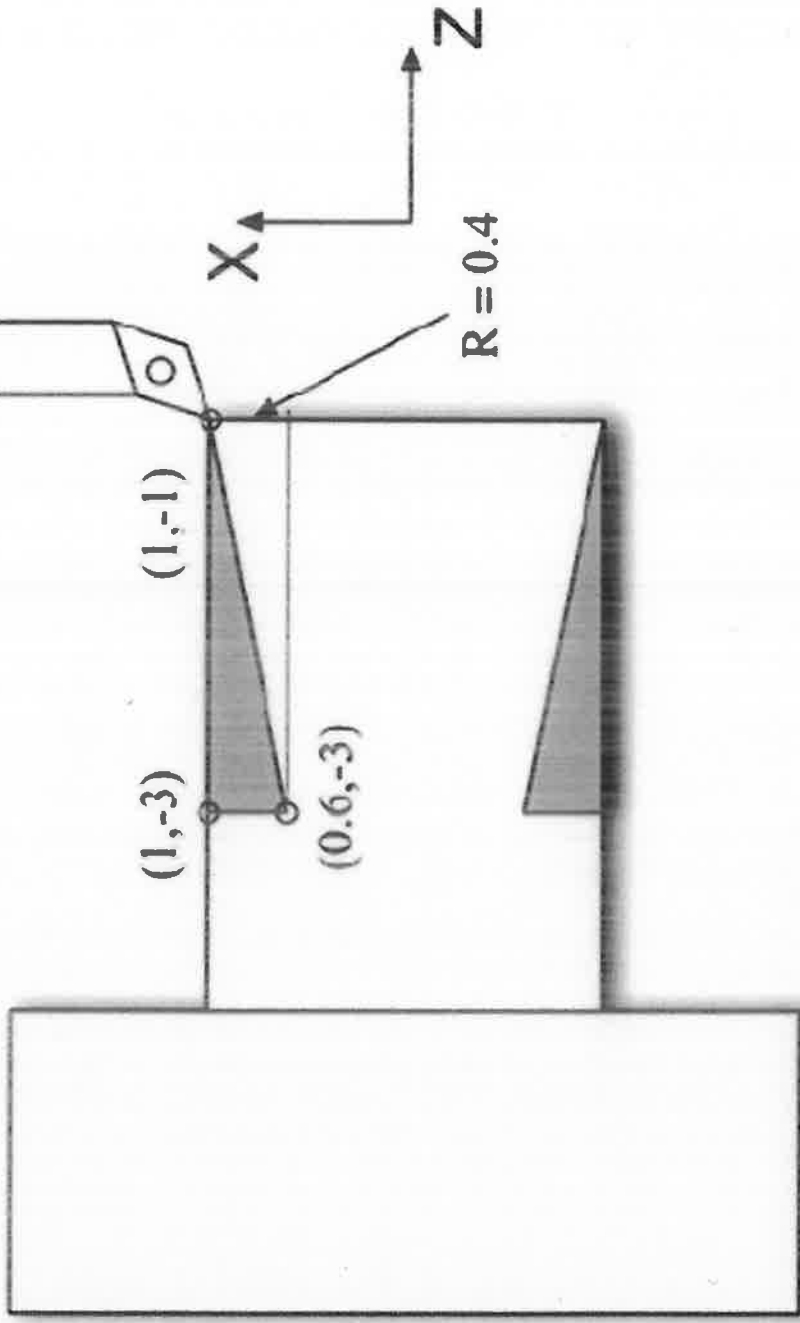

Canned cycle side turning with taper:

N011 G01 X1.0 Z-1.0 F10; Taper start point

N012 G77 X0.6 Z-3.0 Q0.1 R0.4 F10; Taper end point

N013 G80

;R is depth of taper, positive values for negative taper

E.G.S.PILLAY ENGINEERING COLLEGE, NAGAPATTINAM  
DEPARTMENT OF MECHANICAL ENGINEERING  
HANDS ON TRAINING ON CNC PROGRAMMING

**FEED BACK FORM**

- 
- |  |   |
|--|---|
| 1. In the way trainers trained you         | : Excellent / Good / <del>Average</del> |
| 2. Course contents                         | : Excellent / Good / <del>Average</del> |
| 3. In the way trainers cleared your doubts | : Excellent / Good / <del>Average</del> |
| 4. Impact of this program in your career   | : Excellent / Good / <del>Average</del> |
| 5. Practical Sessions                      | : Excellent / <del>Good</del> / Average |
| 6. Suggestions if any                      |   |
- 

*G. Venkatesan*  
Signature  
[G. VENKATESAN]

**ATTESTED**  
*[Signature]*  
**Dr. S. RAMABALAN, M.E., Ph.D.,**  
**PRINCIPAL**  
E.G.S. Pillay Engineering College,  
Thethi, Nagore - 611 002.  
Nagapattinam (Dt) Tamil Nadu.





# EGS PILLAY



## Engineering College

Autonomous

Old Nagore Road, Nagapattinam-611 002, Tamilnadu

Affiliated to Anna University | Approved by AICTE | Accredited by - MBA & NAAC 'A' Grade | Recognised by UGC 2(f) & 12(B) | An ISO 9001:2015 Certified Institution  
Counselling Code : 3806 | 41-865-2511214 | principal@egspon.org enquiries@egsponc.org

## DEPARTMENT OF MECHANICAL ENGINEERING

### Certificate of Participation

This is to certified that Mr./Ms. S. SAKTHIVEL has participated in  
“Hands on training on CNC programming” organized by Department of  
Mechanical Engineering, EGSPEC during 22.02.2019 & 23.02.2019.

V. Sivarajakrishnan,

Program  
Co-ordinator

*Signature*

Dr. S. RAMABALAN, M.E., Ph.D.,

PRINCIPAL

E.G.S. Pillay Engineering College,  
Thethi, Nagore - 611 002.  
Nagapattinam (Dt) Tamil Nadu.

ATTESTED

*Signature*

*Signature*

Principal



# EGS PILLAY



## Engineering College

Autonomous

Old Nagore Road, Nagapattinam-611 002, Tamilnadu

Affiliated to Anna University | Approved by AICTE | Accredited by - NBA & NAAC 'A' Grade | Recognised by UGC 2(B) & 12(B) | An ISO 9001:2015 Certified Institution

Counselling Code : 3806

+91-4365-25112/14 | principal@egspec.org | enquiry@egspec.org

## DEPARTMENT OF MECHANICAL ENGINEERING

### Certificate of Participation

This is to certified that Mr./Ms. S.VENKATESAN has participated in  
“Hands on training on CNC programming” organized by Department of  
Mechanical Engineering, EGSPEC during 22.02.2019 & 23.02.2019.

V. Sivarajakrishnan,

Program

Co-ordinator

Dr. S. RAMABALAN, M.E., Ph.D.,  
PRINCIPAL

E.G.S. Pillay Engineering College,  
Thethi, Nagore - 611 002.

Head of the Department

Principal

ATTESTED





# EGS PILLAY

## Engineering College

Autonomous

Old Nagore Road, Nagapattinam - 611 002, Tamilnadu

Affiliated to Anna University | Approved by AICTE | Accredited by NBA & NAAC 'A' Grade | Recognised by USC 2(F) & 12(B) | An ISO 9001:2015 Certified Institution

Counselling Code : 3806

+91-4368-251112/14 | principal@egspec.org/enquires@egspec.org

## DEPARTMENT OF MECHANICAL ENGINEERING

### Certificate of Participation

This is to certified that Mr./Ms. K. RAJASEKARAN has participated in  
“Hands on training on CNC programming” organized by Department of  
Mechanical Engineering, EGSPEC during 22.02.2019 & 23.02.2019.

V. Sivaravakrishnan,

Program

Co-ordinator

ATTESTED

Dr. S. RAMABALAN, M.E., Ph.D.,  
PRINCIPAL

E.G.S. Pillay Engineering College,  
Thethi, Nagore - 611 002.

Head of the Department

Nagapattinam (Dt) Tamil Nadu.

Principal



# EGS PILLAY



## Engineering College

Autonomous

Old Nagore Road, Nagapattinam-611 002, Tamilnadu

Affiliated to Anna University | Approved by AICTE | Accredited by - NBA & NAAC 'A' Grade | Recognised by USC 210 & 1201 | An ISO 9001:2015 Certified Institution  
Counselling Code : 3808 | Phone : +91 4365 25111/14 | principal@egspec.org/enquiries@egspec.org

## DEPARTMENT OF MECHANICAL ENGINEERING

### Certificate of Participation

This is to certified that Mr./Ms. S. RAMAMOORTHY has participated in  
“Hands on training on CNC programming” organized by Department of  
Mechanical Engineering, EGSPEC during 22.02.2019 & 23.02.2019.

V. Sivaramakrishnan,

Program  
Co-ordinator

ATTESTED

Dr. S. RAMABALAN, M.E., Ph.D.,  
PRINCIPAL

E.G.S. Pillay Engineering College,  
Thevhi, Nagore - 611 002.

Head of the Department  
Nagapattinam (Dt) Tamil Nadu.

Principal





# EGS PILLAY

## Engineering College

Autonomous

Old Nagore Road, Magapattinam-611 002, Tamilnadu

Affiliated to Anna University | Approved by AICTE | Accredited by - NBA & NAAC 'A' Grade | Recognised by UGC 2(F) & 12(B) | An ISO 9001:2015 Certified Institution

Counselling Code : 3806

+91-4365-2511214 | principal@egspeg.org | enquires@egspeg.org

# DEPARTMENT OF MECHANICAL ENGINEERING

## Certificate of Participation

This is to certified that Mr./Ms. G. CHELLAPPAN has participated in  
“Hands on training on CNC programming” organized by Department of  
Mechanical Engineering, EGSPEC during 22.02.2019 & 23.02.2019.

V. Sivananandhan,

Program  
Co-ordinator

ATTESTED

Dr. S. RAMABALAN, M.E., Ph.D.,  
PRINCIPAL

E.G.S. Pillay Engineering College,  
Thethi, Nagore - 611 002.

Head of the Department  
Principal



# EGS PILLAY



## Engineering College

Autonomous

Old Nagore Road, Magapattinam-611 002, Tamilnadu

Affiliated to Anna University | Approved by AICTE | Accredited by - NBA & NAAC 'A' Grade | Recognised by UGC 2(F) & 12(B) | An ISO 9001:2015 Certified Institution

Counselling Code - 3806

+91-4365-25112/14 | principal@egscollege.org | enquire@egscollege.org

# DEPARTMENT OF MECHANICAL ENGINEERING

## Certificate of Participation

This is to certified that Mr./Ms. V. RAMU has participated in  
“Hands on training on CNC programming” organized by Department of  
Mechanical Engineering, EGSPEC during 22.02.2019 & 23.02.2019.

V. Sivaravakrishnan,

Program  
Co-ordinator

ATTESTED

Dr. S. RAMABALAN, M.E., Ph.D.,  
PRINCIPAL

E.G.S. Pillay Engineering College,  
Thethi, Nagore - 611 002.

Head of the Department,  
Mechanical Engineering (Dt) Tamil Nadu.

Principal





# EGS PILLAY



## Engineering College

**AUTONOMOUS**

Old Nagore Road, Nagapattinam-611 002, Tamilnadu

Affiliated to Anna University | Approved by AICTE | Accredited by NBA & NAAC 'A' Grade | Recognised by USC 211 & 1215 | An ISO 9001:2015 Certified Institution

Counselling Code : 3808

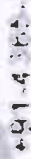
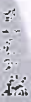

+91-4365-251112,14 | principal@egspec.org | enquires@egspec.org

# DEPARTMENT OF MECHANICAL ENGINEERING

## Certificate of Participation

This is to certified that Mr./Ms. K. BALAMURUGAN has participated in  
"Hands on training on CNC programming" organized by Department of  
Mechanical Engineering, EGSPEC during 22.02.2019 & 23.02.2019.

V. Sivanandakrishnan,

Program  
Co-ordinator

ATTESTED

Dr. S. RAMABALAN, M.E., Ph.D.,  
PRINCIPAL

E.G.S. Pillay Engineering College,  
Nagore - 611 002.  
Nagapattinam (Dt) Tamil Nadu.

Principal



# EGS PILLAY

## Engineering College

Autonomous

Old Nagore Road, Nagapattinam-611 002, Tamilnadu

Affiliated to Anna University | Approved by AICTE | Accredited by - NBA & NAAC 'A' Grade | Recognised by UGC 2(f) & 12(B) | An ISO 9001:2015 Certified Institution

Counselling Code : 3808

4344

+91-4365-2511214 | principal@egspegc.org | enquiries@egspegc.org

# DEPARTMENT OF MECHANICAL ENGINEERING

## Certificate of Participation

This is to certified that Mr./Ms. R. VIJANESH has participated in  
“Hands on training on CNC programming” organized by Department of  
Mechanical Engineering, EGSPREC during 22.02.2019 & 23.02.2019.

V. Sivarajakrishnan,

Program  
Co-ordinator

ATTESTED

Dr. S. RAMABALAN, M.E., Ph.D.,  
PRINCIPAL

E.G.S. Pillay Engineering College,

Nagore - 611 002.

Nagapattinam (Dt) Tamil Nadu.

Head of the Department

Principal





# EGS PILLAY

**Engineering College**

**AUTONOMOUS**

Old Nagore Road, Nagapattinam-611 002, Tamilnadu

Affiliated to Anna University | Approved by AICTE | Accredited by - NBA & NAAC 'A' Grade | Recognised by UGC 2(F) & 12(B) | An ISO 9001:2015 Certified Institution

Counselling Code : 3808

+91-4365-2511214 | principal@egs.ac.in | enquiries@egs.ac.in

## DEPARTMENT OF MECHANICAL ENGINEERING

### Certificate of Participation

This is to certified that Mr./Ms. M. NAGARAJAN has participated in  
“Hands on training on CNC programming” organized by Department of  
Mechanical Engineering, EGSPEC during 22.02.2019 & 23.02.2019.

V. Sivananthan

Program  
Co-ordinator

ATTESTED

Dr. S. RAMABALAN, M.E., Ph.D.,

PRINCIPAL

E.G.S. Pillay Engineering College,

Thethi, Nagore - 611 002.

Head of the Department

Principal